FM 3-07 (FM 100-20)

**Stability Operations
and
Support Operations**

FEBRUARY 2003

HEADQUARTERS, DEPARTMENT OF THE ARMY

DISTRIBUTION RESTRICTION: Approved for public release; distribution is unlimited.

Stability Operations and Support Operations

Contents

	Page
	PREFACE iv
Chapter 1	OVERVIEW 1-1
	Stability Operations Overview 1-3
	Support Operations Overview 1-5
	Historical Context 1-7
	Contemporary Situation 1-8
	United States Policy 1-11
	The Army Role 1-12
	Battlefield Organization 1-13
	Characteristics 1-15
	Foundations 1-19
Chapter 2	PLANNING CONSIDERATIONS 2-1
	Maneuver 2-1
	Intelligence, Surveillance, and Reconnaissance 2-2
	Fire Support 2-6
	Air Defense 2-7
	Mobility/Counter mobility/Survivability 2-8
	Logistics and Combat Service Support 2-10
	Command and Control 2-12
	Other Planning Considerations 2-13
Chapter 3	FOREIGN INTERNAL DEFENSE 3-0
	Categories of FID Operations 3-1

Distribution Restriction: Approved for public release; distribution is unlimited.

*This publication supercedes FM 100-20/AF Pam 3-20; 5 December 1990, FM 100-23; December 1994, FM 90-29; 17 October 1994, and FM 100-19/FMFM 7-10; July 1993.

	The Nature of Counterinsurgency	3-3
	Planning Considerations for FID	3-7
Chapter 4	PEACE OPERATIONS	4-1
	Forms of Peace Operations.....	4-2
	Peacekeeping	4-3
	Peace Enforcement Operations	4-6
	Operations in Support of Diplomatic Efforts	4-11
	Concept of Employment	4-12
	Fundamentals of Peace Operations.....	4-13
	Command and Control	4-19
	Intelligence.....	4-21
	Information Operations	4-24
	Civil Law and Order	4-26
	Logistics.....	4-27
	Force Protection	4-28
Chapter 5	ADDITIONAL STABILITY OPERATIONS	5-1
	Security Assistance	5-1
	Humanitarian and Civic Assistance.....	5-5
	Support to Insurgency	5-6
	Support to Counterdrug Operations	5-6
	Combatting Terrorism.....	5-11
	Noncombatant Evacuation Operations.....	5-13
	Arms Control.....	5-16
	Show of Force.....	5-17
Chapter 6	SUPPORT OPERATIONS	6-1
	Domestic Support Operations	6-1
	Foreign Humanitarian Assistance	6-8
	Forms of Support Operations	6-9
Appendix A	INTERAGENCY COORDINATION	A-0
	National Level	A-0
	Domestic Relief Operations.....	A-1
	Foreign Operations.....	A-3
	Civil-Military Operations Center.....	A-15
	Liaison	A-17

Appendix B	THE LAW IN STABILITY OPERATIONS AND SUPPORT OPERATIONS	B-1
	Applicable Bodies of Law	B-1
	Legal and Regulatory Considerations.....	B-3
	War Powers Resolution	B-7
	Claims Administration	B-8
	Use of Chemical Herbicides and Riot Control Agents	B-8
Appendix C	RULES OF ENGAGEMENT	C-1
	Basis of ROE.....	C-2
	Elements of Self Defense	C-2
	Characteristics of Effective ROE.....	C-2
	Standing Rules of Engagement	C-3
	Interpret, Draft, Disseminate, Train Method.....	C-3
Appendix D	CHARACTERISTICS OF INSURGENCY	D-1
	Leadership	D-1
	Ideology.....	D-2
	Objectives	D-3
	Environment and Geography.....	D-3
	External Support	D-5
	Phasing and Timing	D-5
	Organizational and Operational Patterns.....	D-6
Appendix E	NEGOTIATIONS	E-0
	Considerations	E-0
	Procedures	E-1
	Training	E-5
Appendix F	REFUGEES AND DISPLACED PERSONS	F-0
	Role of the UNHCR.....	F-0
	US Army Internment and Resettlement Operations	F-1
	Displaced Populations	F-1
	Responsibilities of States	F-3
	Nongovernmental Organizations	F-3
	Population Movement	F-4
	Special Considerations	F-4
	GLOSSARY	Glossary-0
	BIBLIOGRAPHY	Bibliography-1
	INDEX	Index-1

Preface

Field Manual (FM) 3-07, Stability Operations and Support Operations, is Tier 1 (principal) doctrine. This manual discusses distinct characteristics of stability operations and support operations, together with doctrinal foundations that facilitate their accomplishment. It amplifies FM 3-0 Chapters 9 and 10. FM 3-07 is conceptual, aiming more at broad understanding than at details of operations.

SCOPE

This manual provides the analytical tools needed to evaluate a stability operation or a support operation. Chapter 1 broadly defines stability operations and support operations. It gives historical examples and provides insight into the contemporary situation. It describes both US policies relating to these actions and the Army's role in them. Chapter 2 discusses planning considerations. Chapters 3 and 4 discuss foreign internal defense and peace operations respectively. Chapter 5 covers additional stability operations not previously discussed, to include counterdrug operations. Chapter 6 discusses the two types and four forms of support operations.

APPLICABILITY

This manual applies to commanders and staffs at all echelons. It addresses the tasks associated with conducting (planning, preparing, executing, and assessing) stability operations and support operations. Tactics, techniques, and procedures (TTP) for specific types of operations in peace and conflict and the application of combined arms and services to them are found in other joint and Army publications. Users should still consult JP 3-07 series of manuals for specific joint information.

ADMINISTRATIVE INSTRUCTIONS

Cross-references use the new field manual numbering system. The bibliography lists field manuals by new number followed by old number.

Unless this publication states otherwise, masculine nouns or pronouns do not refer exclusively to men.

Within this manual, the United States is understood to refer to the United States and its territories.

Within this manual, the term "president" refers to the president and his delegated representatives.

Stability operations and support operations require soldiers to interact with the populace in the area of operations to a greater extent than in offensive and defensive operations. In a combat situation, most people can be classified as enemies or noncombatants. However, during most support operations and many stability operations, this classification is not precise enough. FM 3-07 uses several terms to categorize people in the area of operations. Each term describes the relationship between the individual or group and the Army force. Together, they provide

a framework for leaders and soldiers to use in deciding how to handle situations requiring interaction with people and organizations in the area of operations. The following discussions are not intended to be definitions. They describe how FM 3-07 uses each term. Commanders may define each term as appropriate to the situation in which they are operating. All terms may apply to military, paramilitary, and civilian personnel and groups.

Enemy describes a hostile individual or group that US forces engage—or have a strong potential to engage—in combat. Within US doctrine, the term *enemy* is used as the object or focus of operations throughout the operations process. In the past, *enemy* was associated with opposing combat forces or individuals, whether the forces were military, paramilitary, or civilians committing hostile acts. However, in some stability operations, especially peace operations, referring to one or more factions as “the enemy” damages the perception of US impartiality and hinders the ability to negotiate a peaceful settlement. Thus, the term is reserved for individuals and groups engaging Army forces or their partners in combat operations. In support operations conducted outside a combat zone, the term *enemy* is inappropriate.

A *belligerent* is a group that is inclined, disposed, or eager to fight. It is likely to have previously engaged in combat operations with other belligerents or against Army forces or their partners. A belligerent is not classified as an enemy until it engages Army forces or their partners in combat or has clear intent and capability to do so. Even then, political considerations may preclude designating the group as *enemy*. For example, the Serbs, Muslims, and Croats were belligerents in Bosnia-Herzegovina, but they are not considered the enemy by coalition forces.

An *adversary* is an individual or group that opposes another, especially with animosity. This opposition may be political, diplomatic, or military. An adversary that uses military force against another group may be a belligerent. An adversary that uses military force against Army forces or their partners may be designated an enemy.

A *faction* is a group that forms a cohesive and contentious minority within a larger group. Factions are often categorized along religious, political, or cultural beliefs. The Kosovars are a faction within the population of greater Yugoslavia. Factions can be adversaries or belligerents, irrespective of the category of the group of which they are a faction.

The glossary lists most terms used in FM 3-07 that have joint or Army definitions. Terms for which FM 3-07 is the proponent manual (the authority) are indicated with an asterisk in the glossary. Definitions for which FM 3-07 is the proponent manual are printed in boldface in the text. For other definitions in the text, the term is italicized and the number of the proponent manual follows the definition.

The proponent of this publication is Headquarters, TRADOC. Send comments and recommendations on DA Form 2028 directly to Commander, US Army Combined Arms Center and Fort Leavenworth, ATTN: ATZL-FD-CD, Fort Leavenworth, Kansas 66027-6900.

Chapter 1

Overview

This chapter is a broad overview defining both stability operations and support operations. It places them in historical context and provides insight into the contemporary situation. It describes both United States (US) policies relating to these actions and the Army's role in them. It also discusses distinct characteristics of these operations, together with doctrinal foundations that facilitate their accomplishment.

The Army conducts full spectrum operations to accomplish missions in both war and military operations other than war (MOOTW). Full spectrum operations include offensive, defensive, stability, and support operations (see Figure 1-1 on page 1-2). Offensive and defensive operations normally dominate military operations in war, as well as some smaller-scale contingencies. On the other hand, stability operations and support operations predominate in MOOTW that may include certain smaller-scale contingencies and peacetime military engagements.

The characteristics that make our Army a premier warfighting organization also serve it well in conducting stability operations and support operations. Army forces can quickly respond to conflict and disaster, foreign or domestic, through strategic deployment, pre-positioning, or forward deployment. The Army is versatile in its ability to task organize in size, structure, and functions for widely varying disparate missions. The Army

CONTENTS	
Stability Operations Overview 1-3 Purposes 1-3 Types 1-4 Considerations 1-4 Support Operations Overview 1-5 Purposes 1-6 Types 1-6 Considerations 1-7 Historical Context 1-7 Contemporary Situation 1-8 Trends 1-8 Elements of Instability 1-9 Complex and Uncertain Situations 1-10 United States Policy 1-11 The Army Role 1-12 Legal Basis 1-12 Capabilities 1-12 Battlefield Organization 1-13	Decisive Operations 1-13 Shaping Operations 1-14 Sustaining Operations 1-15 Characteristics 1-15 Political Objectives 1-16 Modified Concept of the Enemy 1-16 Joint, Interagency, and Multinational Coordination 1-16 Risk of Mission Creep 1-17 Noncombatants 1-17 Nongovernmental Organizations 1-17 Information Intensity 1-18 Constraints 1-18 Cross-Cultural Interaction 1-18 Foundations 1-19 Principles of War 1-19 Tenets of Army Operations 1-22

commands the respect of belligerents by the threat of force, or, if that fails, the use of force to compel compliance. The Army is self-sustaining and can provide critical services and supplies directly to the populace of in support of multinational and interagency operations.

Stability operations promote and protect US national interests by influencing the threat, political, and information dimensions of the operational environment through a combination of peacetime developmental, cooperative activities and coercive actions in response to crisis (FM 3-0). Army forces accomplish stability goals through engagement and response. The military activities that support stability operations are diverse, continuous, and often long-term. Their purpose is to promote and sustain regional and global stability.

Support operations employ Army forces to assist civil authorities, foreign or domestic, as they prepare for or respond to crisis and relieve suffering (FM 3-0). The primary role of support operations is to meet the immediate needs of designated groups, for a limited time, until civil authorities can accomplish these tasks without military assistance. Support operations also have two subordinate types: domestic support operations and foreign humanitarian assistance.

TYPES OF MILITARY OPERATIONS	OFFENSE	DEFENSE	STABILITY	SUPPORT
	<p>Types of Offensive Operations</p> <ul style="list-style-type: none"> • Movement to Contact • Attack • Exploitation • Pursuit 	<p>Types of Defensive Operations</p> <ul style="list-style-type: none"> • Area Defense • Mobile Defense • Retrograde 	<p>Types of Stability Operations</p> <ul style="list-style-type: none"> • Peace Operations • Foreign Internal Defense • Security Assistance • Humanitarian and Civic Assistance • Support to Insurgencies • Support to Counter-drug Operations • Combatting Terrorism • Noncombatant Evacuation Operations • Arms Control • Show of Force 	<p>Types of Support Operations</p> <ul style="list-style-type: none"> • Domestic Support Operations • Foreign Humanitarian Assistance
	<p>Forms of Maneuver</p> <ul style="list-style-type: none"> • Envelopment • Turning Movement • Frontal Attack • Penetration • Infiltration 			
TYPES OF TACTICAL ENABLING OPERATIONS	<ul style="list-style-type: none"> • Reconnaissance Operations • Security Operations • Troop Movement • Breach 		<ul style="list-style-type: none"> • River Crossing • Relief in Place • Passage of Lines • Information Operations 	

Figure 1-1. Stability Operations and Support Operations

US forces conduct stability operations and support operations to deter war, resolve conflict, promote peace, strengthen democratic processes,

retain US influence or access abroad, assist US civil authorities, and support moral and legal imperatives. These actions include a range of activities. They provide policy makers with options to pursue national policy objectives. As military operations, they can be applied to complement any combination of the other elements of national power. It is difficult to generalize about stability operations and support operations. They can be long or short, unilateral or multinational, domestic or foreign, developmental or coercive. They are often joint and interagency operations. Non-governmental organizations (NGOs) add to the complexity of these operations. Like all operations, stability operations and support operations are sensitive to political considerations and support national objectives. However, they may also have more restrictive rules of engagement than offensive and defensive operations. FM 3-0 explains that stability operations and support operations may be conducted during peacetime, conflict, or war; at all echelons; and simultaneously or sequentially to accomplish assigned missions. Figure 1-1 shows how stability operations and support operations relate to offensive and defensive operations.

STABILITY OPERATIONS OVERVIEW

1-1. Stability operations may complement and reinforce offensive, defensive, and support operations, or they may be the decisive operation. They may take place before, during, and after offensive, defensive, and support operations.

1-2. During hostilities, stability operations help keep armed conflict from spreading while assisting and encouraging committed partners. They seek to secure the support of civil populations in unstable areas. Forces engaged in a stability operation may have to conduct offensive and defensive operations to defend themselves or destroy forces seeking to challenge the stability mission. Following hostilities, forces may conduct stability operations to provide a secure environment for civil authorities as they work to achieve reconciliation, rebuild lost infrastructure, and resume vital services.

PURPOSES

1-3. Some of the many purposes for which Army forces are employed to conduct stability operations are to—

- Protect national interests.
- Promote peace and deter aggression.
- Satisfy treaty obligations or enforce agreements and policies.
- Reassure allies, friendly governments, and agencies.
- Maintain or restore order.
- Protect life and property.
- Demonstrate resolve.
- Prevent, deter, or respond to terrorism.
- Reduce the threat of arms and weapons of mass destruction (WMD) to regional security.

- Promote sustainable and responsive institutions.
- Promote freedom from oppression, subversion, lawlessness, and insurgency.

TYPES

1-4. Stability operations typically fall into ten broad types that are neither discrete nor mutually exclusive. For example, a force engaged in a peace operation may also find itself conducting arms control or a show of force to shape the conditions for achieving an end state. Figure 1-2 shows stability operations.

TYPES OF MILITARY OPERATIONS	OFFENSE	DEFENSE	STABILITY	SUPPORT
TYPES OF STABILITY OPERATIONS AND THEIR SUBORDINATE FORMS	Peace Operations <ul style="list-style-type: none"> • Peacekeeping • Peace Enforcement • Operations in Support of Diplomatic Efforts Foreign Internal Defense <ul style="list-style-type: none"> • Indirect Support • Direct Support • Combat Operations Security Assistance Humanitarian and Civic Assistance Support to Insurgencies <ul style="list-style-type: none"> • Unconventional Warfare • Conventional Combat Actions Support to Counterdrug Operations <ul style="list-style-type: none"> • Detection and Monitoring • Host-Nation Support • C4 • Intelligence, Planning, CSS, Training, and Manpower Support • Reconnaissance 		Combatting Terrorism <ul style="list-style-type: none"> • Antiterrorism • Counterterrorism Noncombatant Evacuation Operations Arms Control <ul style="list-style-type: none"> • Inspection • Protection • Destruction Show of Force <ul style="list-style-type: none"> • Increased Force Visibility • Exercises and Demonstrations 	

Figure 1-2. Stability Operations

CONSIDERATIONS

1-5. While each operation is unique, the considerations listed below help forces conduct (plan, prepare, execute, and assess) stability operations.

1-6. **Leverage interagency, joint, and multinational cooperation.** As with all operations, unity of effort is fundamental to success. (See the discussion of Unity of Command later in this chapter.)

1-7. **Enhance the capabilities and legitimacy of a host nation.** Army forces consciously enhance host-nation credibility and legitimacy by demonstrating the proper respect for the host-nation government, police, and military forces. Within the restrictions of international law and US policy, commanders use host-nation forces and personnel for all possible activities. Within its capabilities, a host nation should take the lead in both developmental and security activities. When host-nation capabilities prove inadequate for the task,

Army forces enhance those capabilities through training, advice, and assistance.

1-8. ***Understand the potential for unintended consequences of individual and small-unit actions.*** The actions of individuals and units can have consequences disproportionate to the level of command. An individual's actions can even have strategic implications. Soldiers and leaders who are disciplined, proficient, and knowledgeable in stability operations can create the opportunity for disproportional positive consequences, while limiting the risk for negative consequences.

1-9. ***Display the capability to use force in a nonthreatening manner.*** Army forces must be prepared for combat in stability operations. However, that preparedness is shown so it does not provoke potential adversaries. The force demonstrates strength and resolve without being perceived as threatening. Consistent with mission constraints, units display preparedness by routinely conducting demanding combined arms training in the area of operations (AO). The force should convey to all parties the breadth and depth of the resources available. To do so, it must be present in the communities and ensure—consistent with the demands of operations security (OPSEC)—that the general public knows the rules of engagement (ROE) and associated graduated response levels. Training should include challenging soldiers to react to situations at all levels in the areas of weapons use, levels of force, and ROE.

1-10. ***Act decisively to prevent escalation.*** The nature of stability operations ordinarily constrains forces in the ways and means available to accomplish military objectives. However, they are characterized by initiative, speed, and determination when action is necessary. Units and individuals pursue military objectives energetically and apply military power forcefully if required. Army forces may act decisively to dominate a situation by force or negotiate to settle disputes. Without hesitation, they ensure mission accomplishment as well as protection of themselves, the people, and facilities under their charge. Decisiveness reassures allies and deters adversaries. Failure to act decisively causes a loss of respect for the stability force. A loss of respect for the capabilities or will of the force to accomplish its mission can embolden adversaries and weaken the trust of the supported population making the mission much more difficult.

1-11. ***Apply force selectively and discriminately.*** Commanders ensure that their units apply force consistent with assigned objectives and not excessive. Combat power is applied selectively in accordance with assigned missions and prescribed limitations. Excessive force can lead to the loss of sympathy and support of local and international populations. Inadequate force may jeopardize mission accomplishment *and* adversely impact the local populace and domestic support. Ordinarily, the local commander is best qualified to estimate the degree of force that must be used, consistent with established ROE.

SUPPORT OPERATIONS OVERVIEW

1-12. Support operations may occur independently; however, more often they complement offensive, defensive, and stability operations. Many offensive, defensive, and stability operations often require complementary support

operations before, during, or after execution. These may range from transporting, feeding, and providing shelter for displaced persons to providing medical care for people and livestock.

PURPOSES

1-13. Support operations are generally conducted to assist civil authorities in response to emergencies (natural or man-made disasters) or specified illegal activities, and to relieve or reduce suffering. Support operations meet the immediate needs of civil authorities or designated groups for a limited time until they can accomplish these tasks without military assistance. In extreme or exceptional cases, Army forces may provide relief or assistance directly to those in need.

TYPES

1-14. Two types of support operations exist: domestic support operations (DSO) and foreign humanitarian assistance (FHA). Figure 1-3 shows the types of support operations and their subordinate forms.

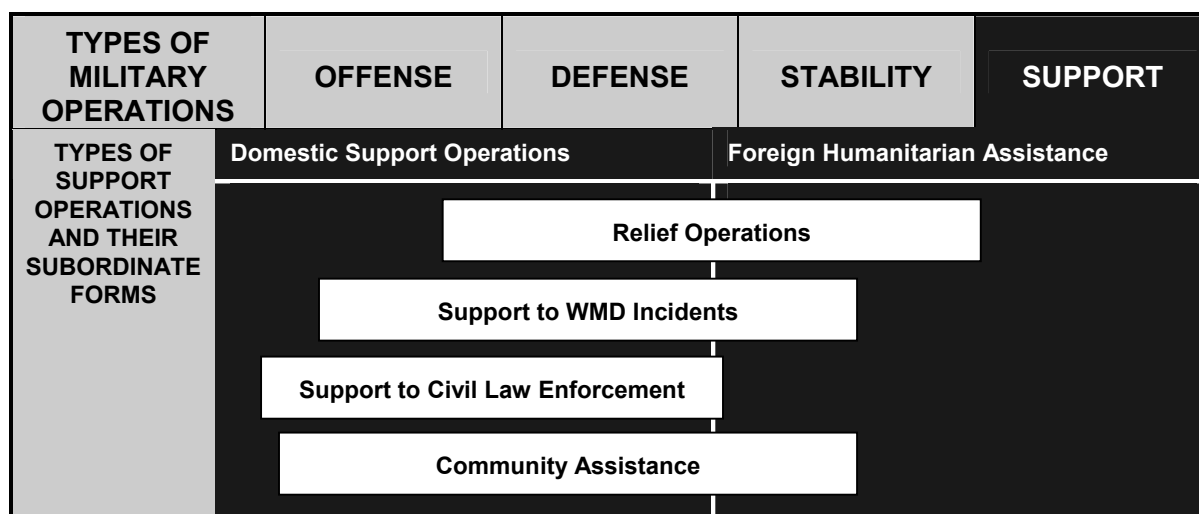

Figure 1-3. Support Operations

1-15. DSO are usually conducted after the president declares an emergency. However, a commander may also conduct them following a finding by the secretary of defense, secretary of the Army, general officer, or an equivalent civilian or as an immediate response to an emergency under imminently serious conditions. Domestic support operations supplement the efforts of civil governments and voluntary organizations. The Army normally responds to domestic emergencies in support of another federal agency.

1-16. FHA operations apply Army forces to supplement the efforts of the host-nation civil authorities or agencies by conducting activities limited in scope and duration. FHA relieves or reduces the impact of natural or man-made disasters or other endemic conditions—such as human pain, disease, hunger, or privation—that might seriously threaten life or result in great damage to or loss of property. Army forces participate in FHA

operations that may be unilateral, multinational, or coordinated by an international organization such as the United Nations.

CONSIDERATIONS

1-17. While each operation is unique, commanders and staff should weigh some general considerations to help plan and execute support operations.

1-18. ***Provide essential support to the largest number of people.*** The principle of essential support to the greatest number guides prioritization and allocation. Whenever feasible, Army forces simultaneously accomplish as many tasks as possible. In some cases, it may be necessary to complete a lower-priority task to accomplish a higher task. For example, the forces may need to restore limited electric services (lower-priority task) to power hospital emergency rooms and shelters (higher-priority task).

1-19. ***Coordinate actions with other agencies.*** Coordination with other agencies, especially the international lead agency, is critical in support operations for two reasons. First, they tend to be conducted with joint, interagency, or multinational participation. Second, the Army is often in support of another agency. Achieving unity of effort requires constant coordination. In addition, each participant will likely bring unique capabilities that will be in constant demand. Effectively integrating these scarce resources requires planning and coordination.

1-20. ***Establish measures of effectiveness.*** In support operations, objective standards for determining progress toward the end state are necessary and are a critical aspect of mission handover. These measures of effectiveness determine the degree to which a support operation is accomplishing established objectives. Criteria of success in support operations focus primarily on the condition and activity of those supported. In famine relief, for example, the rate of decline in the mortality rate more accurately denotes success than the amount of food delivered.

1-21. ***Hand over to civilian agencies as soon as feasible.*** Support operations usually assist governmental and nongovernmental agencies in accomplishing their missions. The Army reinforces or complements their efforts. While Army forces may play a lead role in some aspects or phases of the operation, they should work to hand over responsibility to appropriate civilian agencies at the earliest opportunity.

HISTORICAL CONTEXT

1-22. Stability operations and support operations are not new to the Army. From the start of American history, the government has called on its armed forces to pursue US strategy. The Army, as an instrument of national power, promoted and protected national interests, and relieved human suffering. The Army helped open the West. It conducted explorations, governed territories, guarded national parks, made maps, and built roads and canals. The Army also provided disaster relief, quieted domestic disturbances, and supported American foreign policy (for example, conducting stability operations in the Philippines from 1899–1904 and Haiti from 1915–1934).

1-23. While many of these operations occurred during peacetime, what the Army now calls stability operations and support operations emerged during the 20th century as a major contributor to the overall success of combat operations. During World War II, for example, US forces assisted the local governments and populace in reconstructing the civil infrastructures of France, Belgium, Luxembourg, and the Netherlands. They fed starving civilians, rebuilt bridges and roads, and demined extensive tracts of farmland while full-scale combat operations continued to take place against conventional enemies. During the Vietnam conflict, Army units conducted “pacification,” which involved civil-military operations such as assistance to civil authorities for security and administration. The Army has repeatedly been called to respond to the nation’s requirements, both at home and overseas.

CONTEMPORARY SITUATION

1-24. Many modern conflicts do not directly affect the interests of the United States. Others, however, affect US humanitarian interests, access to markets and materials, the safety of our citizens, and the stability necessary to sustain democratic government. These threats to US national interests may require stability operations or support operations in response.

1-25. Analysis of current trends can help us describe the contemporary situation and prepare for stability operations and support operations. In addition to trend analysis, examining the elements of instability can help describe the contemporary situation.

TRENDS

1-26. The current strategic environment is complex, dynamic, and uncertain. Trends indicate that the demands placed on the Army to conduct operations in the 21st century will be greater than ever. Army forces will be called to prevent escalation of conflict and respond to more foreign or domestic crises or emergencies that significantly impact on US national interests. Our current national security strategy of engagement often requires Army forces to be committed to secure those interests at home and abroad. Figure 1-4 depicts the increasing frequency of US military involvement and unanticipated contingencies that require stability operations and support operations.

1-27. Few states will have the resources, or the need, to attack the US directly in the near future. However, many will challenge it for control or dominance of a region. Potential adversaries may increasingly resort to asymmetric means to threaten our national interests. Such methods include unconventional, unexpected, innovative, or disproportional means used to gain an advantage. Adversaries may use inexpensive approaches that circumvent the US strengths, exploit its vulnerabilities, or confront it in ways the US cannot match in kind. Contemporary threats include terrorism; chemical, biological, radiological, nuclear, and high-yield explosive (CBRNE) threats; information operations; exploitation of commercial or space-based systems; denial of our access to critical resources; and environmental sabotage.

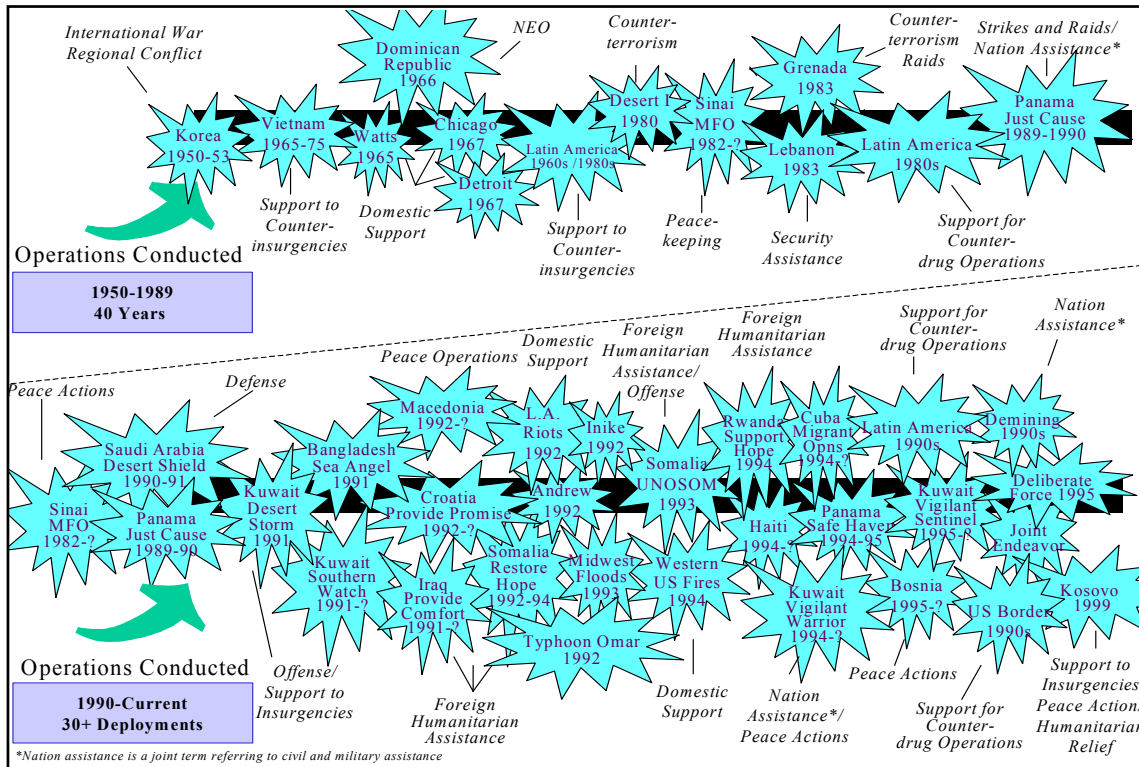

Figure 1-4. Increasing Frequency of Operations

ELEMENTS OF INSTABILITY

Balance of Power

1-28. Nation states will continue to be the primary political unit for the foreseeable future. Yet the process of globalization is changing the nature of state-to-state relations as the reach of nonstate actors, multinational corporations, and international organizations increases. Shifting and unstable power balances at the national and subnational levels in the Balkans, Middle East, and throughout Africa and Asia threaten to engage the vital interests of the United States.

Nationalism

1-29. Some forms of nationalism can cause inter- and intrastate conflict. Nationalist movements arise from the belief that nations benefit from acting independently rather than collectively, emphasizing national rather than international goals. Many sources of nationalist identity exist, including ethnic, religious, tribal, historical, or territorial. Such movements are replacing ideologically based identities. In some cases, these movements are closely linked to criminal organizations. These movements may also cause regional strife, as one nation seeks to extend its authority over adjacent groups or territory.

Clash of Cultures

1-30. Some in the non-Western world reject Western political and cultural values. In some instances, regimes that use Western political forms of government are under attack by ethnic, religious, and nationalist groups seeking to establish or reestablish their identity. As tribal, nationalist, or religious movements compete with Western models of government, instability can increase. This instability threatens not only Western interests within the state, but often threatens to spill across borders.

Demographics

1-31. Population growth, particularly in the less-developed world, is straining the resources and social structures of the states affected. Because much of the world's population growth occurs in areas prone to natural disasters and famine, such events can cause mass migrations.

Ungovernability

1-32. The ability of governments to govern effectively is being eroded in much of the world. The global economy can render economic policies and controls ineffective; throughout the world, some governments fail to provide economic stability and security for their populace. The collapse of some command economies has created problems of distribution and structural unemployment. Immature government infrastructures in developing democracies can cause expectations to be unmet, often leading to conflict. Unsuccessful demobilization and reintegration schemes, coupled with the widespread availability of weapons, have contributed to increased crime in postconflict situations. Organized crime has taken advantage of such situations to subvert the institutions of the state in many areas of the world.

Environmental Risks

1-33. Conditions that pose serious environmental risks may add to future instability. Natural disasters, climate changes, and degradation of the existing natural environment can ruin a local economy, possibly creating a conflict over scarce resources and large population movements. Man-made crises may also cause tension. Cross-border pollution will cause tension, both within regions and between developed and less developed nations. Additionally, questions of securing or safely controlling nuclear or chemical facilities may provoke military operations designed to secure both weapons and plants on environmental as well as political grounds.

Propaganda

1-34. Both governments and nonstate actors use propaganda to create awareness and influence opinion. Increased public access to information and the increased ability of various groups to manipulate the media challenge the authority of major institutions and may even threaten the sovereignty of some states.

COMPLEX AND UNCERTAIN SITUATIONS

1-35. Stability operations and support operations often take place in political, military, and cultural situations that are highly fluid and dynamic.

Unresolved political issues, an unclear understanding or description of a desired end state, or difficulty in gaining international consensus may cause ambiguity. Complexity in these actions may also arise from—

- Troops dispersed throughout the AO.
- Difficulty in discriminating between combatants and noncombatants or between the many parties of a dispute.
- Undisciplined factions, uncontrolled by a central authority and unwilling to consent to the agreement.
- Absence of basic law and order.
- Violations of human rights.
- Widespread destruction or decay of physical and social infrastructure and institutions; collapse of civil infrastructure.
- Environmental damage.
- Threats of disease or epidemics.
- Presence of many displaced persons.
- Presence and involvement of nongovernmental organizations, media, and other civilians.

1-36. Presidential Decision Directive (PDD) 56 recognized the complexity of future stability operations and support operations and the requirement for detailed interagency planning and coordination. The Army's response to crises will have to address simultaneously several components, such as political, diplomatic, humanitarian, economic, and security.

1-37. These operations require that leaders and soldiers be familiar with the area of operation and any complex ethnic and cultural issues. Commanders strive to translate political direction into attainable military objectives. Political objectives by their nature are not static and will change with the situation. Commanders must anticipate these changes through situational understanding and adapt as necessary.

UNITED STATES POLICY

1-38. The Army is an essential player in pursuing US policy objectives. The national political leadership uses all the instruments of national power to pursue its policy objectives. The Army and the other military services make up the military instrument of national power. The president outlines US security policy in the national security strategy (NSS). The Chairman of the Joint Chiefs of Staff is responsible for the national military strategy (NMS), which implements presidential guidance and provides the strategic direction of the armed forces.

1-39. Stability operations and support operations make an important contribution to further the NSS and NMS. The worldwide participation of Army forces in these operations demonstrates our commitment; improves interoperability; reassures allies; promotes transparency; conveys democratic ideals; deters aggression; and helps address sources of instability before they can become military crises. Stability operations and support operations are crucial to responding to crises by providing many options other than offense and defense. Such options allow policy makers to apply military power selectively to shape the security environment.

1-40. The combatant commander provides theater strategy. National security strategy, national military strategy, and other policies shape theater strategy. Theater strategy provides guidance to subordinate commands for executing campaign plans and employing unified forces. Stability operations and support operations are executed in accordance with theater strategy and are often important elements in theater engagement planning. FM 3-93 details the relationship between the NSS, NMS, and theater strategy.

1-41. FM 1 discusses the framework within which the president uses employment considerations in deciding how to use military force to pursue strategic or national objectives. Decision makers ask themselves a series of questions that help them decide whether the mission is advisable. They determine if the purpose for which the force is contemplated is attainable, and if it is likely to be decisive. Is the military element of national power the appropriate element to use? Do the American people, through their elected representatives, support the employment of American military forces? What are the end state criteria? A similar examination may be required to employ forces in stability operations or support operations.

THE ARMY ROLE

1-42. Army forces are employed worldwide in stability operations and support operations for two key reasons:

- Policy and legal bases for such activities exist.
- Army capabilities are often the best choice to meet the requirement.

LEGAL BASIS

1-43. The legal basis for conducting stability operations and support operations is found in Title 10 (Armed Forces) and Title 32 (National Guard) of the United States Code (USC). Title 10 states that, in addition to fighting and winning America's wars, the Army also has other important purposes. Figure 1-5 is an excerpt from Title 10 USC, section 3062.

1-44. Department of Defense (DOD) Directive (DODD) 5100.1 specifies that the DOD maintains forces to uphold and advance the national policies and interests of the United States and safeguards its internal security. History has shown that stability operations and support operations are an integral part of the military contribution to those objectives.

CAPABILITIES

1-45. The Army is called on to respond to emergencies because it can rapidly marshal and apply the required resources and capabilities to meet the requirement. As discussed earlier, the Army has a rich history of participation in stability operations and support operations. The president has repeatedly asked the Army to respond decisively to natural or man-made emergencies. Certain capabilities stand out in the conduct of stability operations and support operations. Among them is the Army's ability to—

- Task organize to tailor the force rapidly to meet varying requirements. Army forces can communicate locally, regionally, and globally. Unity of command allows pursuit of assigned objectives as a united team.

- Deploy or be employed anywhere in nearly any environment and operate in austere and undeveloped areas.
- Use logistic systems to facilitate sustainment capability across the spectrum of conflict. Army forces are suited to react quickly when called to provide logistic support for domestic and foreign, natural, or man-made disasters. Strategic deployment requires both air and sea lines of communications, while the Army maintains the structure and expertise to develop, acquire, and supply the equipment and supplies for conducting full spectrum operations on land.
- Control terrain and influence the population in the area of operations to ensure freedom of action. Soldiers have the inherent capability to protect themselves and the ability to protect others, if necessary.

It is the *intent* of Congress to provide an Army that is capable, in conjunction with the other armed forces, of —

(1) preserving the peace and security, and providing for the defense, of the United States, the Territories, Commonwealths, and possessions, and any areas occupied by the United States;

(2) supporting the national policies;

(3) implementing the national objectives; and

(4) overcoming any nations responsible for aggressive acts that imperil the peace and security of the United States.

Figure 1-5. Excerpt from Title 10 USC, Section 3062

BATTLEFIELD ORGANIZATION

1-46. While each stability operation or support operation is unique, each is designed and executed according to the framework established in FM 3-0. Battlefield organization is the allocation of forces in the AO by purpose. Commanders organize their forces according to their purpose for each unit by determining whether the operations of each will be decisive, shaping, or sustaining. These decisions form the basis of a commander's concept of operations. As in any operation, the military decision making process (MDMP) found in FM 5-0 helps determine the specific decisive, shaping and sustaining operations. The MDMP is in accordance with the factors of mission, enemy, terrain and weather, troops and support available, time available, civil considerations (METT-TC).

DECISIVE OPERATIONS

1-47. *Decisive operations* are those that directly accomplish the task assigned by the higher headquarters. Decisive operations conclusively determine the outcome of major operations, battles, and engagements (FM 3-0). In stability operations, decisive operations are usually those that achieve and maintain stability, protect lives and property, or promote peace. Unlike decisive operations in the offense or defense, decisive operations in stability operations do not always have immediate impacts; sometimes results take

years to achieve. Decisive operations could include disarming belligerents in a conflict or assisting in the conduct of an election.

1-48. In support operations, decisive operations normally prevent or mitigate the effects of natural or man-made disasters. They relieve or reduce conditions such as disease, hunger, or privation. Decisive to these operations could be stabilizing areas by providing security for personnel, facilities, or capabilities; rendering certain services to populations; or reestablishing critical infrastructure. Figure 1-6 describes the infrastructure.

Efforts that focus on infrastructure may include reestablishing or securing—

- **Vital human services:** hospitals, water supplies, waste and hazardous material storage and processing, emergency services (police, fire, rescue).
- **Civil administration:** legislative, judicial, and administrative functions.
- **Communications and information:** television, radio, telephone, Internet, newspapers, magazines, and computer systems.
- **Transportation and distribution:** highways, railways, ports, waterways, pipelines, airports, mass transit and trucking companies.
- **Energy:** production, storage, and distribution of electric power, oil, and natural gas.
- **Commerce:** key industries and other business, banking, and finance.

Figure 1-6. The Elements of Infrastructure

1-49. Stabilizing an area can be decisive in both stability operations and support operations. To protect people and necessary infrastructure, it is often critical to establish order. In this situation, operations such as police support, static area security, and security patrols may be decisive because they deter criminal activity and reassure the population that they will be protected from lawlessness or violence. In addition, providing for basic human needs such as food, water, shelter, and medical care may also be decisive.

SHAPING OPERATIONS

1-50. *Shaping operations* at any echelon create and preserve conditions for the success of the decisive operation (FM 3-0). In stability operations, shaping operations often convert temporary gains into long-term political success. The capabilities required to exploit stability often differ from those needed to achieve stability. This may require such measures as rotating different types of units in and out of the AO, as the operation progresses through different stages. Shaping operations can aim to keep newly gained stability from being undone. Shaping operations may focus on identifying and cooling potential flash points that can occur after initial stabilization efforts. Typical flash points include disarmament, repatriation, resettlement, elections, recovery of remains, resource distribution, and prevention of retribution. Commanders must consider local law and custom, as they must avoid unknowingly, or without due consideration, favoring a particular group or faction in subsequent political contests. Examples of typical shaping operations include evacuating noncombatants to facilitate decisive operations, negotiating and mediating to help settle a dispute, influencing targeted groups through offensive

information operations, and operating checkpoints to carry out a given mandate.

1-51. In support operations, shaping operations may include influencing perceptions, ideas, and information as well as maintaining legitimacy. Civil-military operations are shaping operations that gain favor with the local populace and government and influence positive attitudes and perceptions. Shaping operations will entail transferring tasks to civilian agencies or the local government. As they do in all operations, commanders weigh how their actions affect follow-on operations aimed at achieving long-term solutions.

SUSTAINING OPERATIONS

1-52. *Sustaining operations* are operations at any echelon that enable shaping and decisive operations by providing combat service support, rear area and base security, movement control, terrain management, and infrastructure development (FM 3-0). Commanders must actively and aggressively protect the sustainment base of their operations. Often the base is the focal point of the stability effort and an attractive target for antagonists. In many stability operations and support operations, commanders operate from various bases spread throughout the area of operations. In these instances, sustaining operations must include measures to protect the lines of communications between the bases. They may also include actions taken in concert with local authorities to protect local sources of essential supplies and services. Supporting the friendly force through rest, recuperation, and refit are also sustaining operations.

CHARACTERISTICS

1-53. Because units typically prepare and train for offensive and defensive operations, stability operations and support operations often not only require a mental adjustment, but also a requirement to be proficient in unfamiliar tasks and missions. DODD 2000.13 requires the Army to be able to conduct various civil affairs activities, to include performing civilian sector functions and exercising military control of the civilian population in occupied or liberated areas. Stability operations and support operations differ from the offense and defense in significant ways. Understanding their characteristics helps units successfully adapt to the special requirements presented. Figure 1-7 lists some common characteristics. Although not applicable in every operation, these characteristics apply to many operations. Understanding them aids in the adjustment that units may be required to make when conducting these types of actions.

- | Characteristics |
|--|
| <ul style="list-style-type: none"> • Political objectives • Modified concept of the enemy • Joint, interagency, and multinational coordination • Risk of mission creep • Noncombatants • Nongovernmental organizations • Information intensity • Constraints • Cross-cultural interaction |

Figure 1-7. Characteristics of Stability Operations and Support Operations

POLITICAL OBJECTIVES

1-54. Political objectives influence stability operations and support operations at every level from strategic to tactical. These operations are distinguished by the degree that political objectives directly influence operations and tactics. Two factors about political primacy stand out. First, all military personnel should understand the political objectives and the potential impact of inappropriate actions. Having an understanding of the political objective helps avoid actions that may have adverse political effects. In such operations, junior leaders commonly make decisions that have significant political implications. Second, political objectives can be fluid. Changing objectives may warrant a change in military operations. Commanders should strive, through continuing mission analysis, to detect subtle changes that may lead to disconnects between political objectives and military operations. Failure to recognize changes in political objectives may lead to ineffective or counterproductive military operations.

1-55. Political objectives can change due to unexpected events or decisions by political leaders or groups. Changes in the political environment may render a political objective obsolete. Commanders must strive to understand the political objectives of all involved entities and their impacts on the mission. Commanders must also inform political authorities as situations change.

1-56. Political primacy applies in all kinds of stability operations and support operations. For example, peace operations support diplomacy, the major tool of the political instrument. Noncombatant evacuation operations support the department of state. Foreign humanitarian assistance has nonmilitary objectives. In all these and other operations, Army forces support executing national policy. The political instrument of national power dominates every aspect of operations.

MODIFIED CONCEPT OF THE ENEMY

1-57. Stability operations and support operations require a modified understanding of who or what is the adversary. Commanders must take care to not create an enemy where one does not exist. In situations where there is no enemy, military capability may focus on overcoming obstacles and providing support to other agencies.

1-58. In some stability operations, such as peacekeeping, Army forces must be impartial to preserve the legitimacy of their mission. Antagonism by the parties can threaten to drag the peacekeeping force into the dispute. In such situations, the peacekeeping force must resist the natural inclination to designate antagonists, or those who fail to comply with an agreement or accord, as *the enemy*.

JOINT, INTERAGENCY, AND MULTINATIONAL COORDINATION

1-59. Stability operations and support operations typically involve unified action: joint, interagency, and multinational efforts. The increased number of participants (military and nonmilitary) and their divergent missions and methods create a coordination challenge. In this environment, the potential exists for duplicating effort and working at cross-purposes. Achieving unity of

effort requires the greatest possible common purpose and direction among all agencies.

RISK OF MISSION CREEP

1-60. In many operation, deterring mission creep is difficult since civilian agencies and US forces inherently desire to do more than is required, especially when faced with human suffering. However, well-intentioned actions can be especially dangerous in stability operations and support operations, where they can threaten impartiality as well as undermine long-term programs.

1-61. There are two types of mission creep. First is the type that occurs when the unit receives shifting guidance or change in mission for which the unit is not properly configured or resourced; or if it is beyond the legal remit of the Army. An example would be a peacekeeping force required to perform peace enforcement tasks without additional resources. The second type of mission creep occurs when a unit attempts to do more than is allowed in the current mandate and mission. An example would be if a commander directed execution of civil action projects that fall outside his authority. Rebuilding structures, training local nationals, and other activities may be good for the local population, but they may be beyond the mandate and mission.

1-62. Mission creep may develop from inadequate or false assumptions, misinterpreted intent, or unrealistic development of implied tasks in planning. It can also derive from well-meaning but erroneous interpretation of law or regulation. Mission creep can be avoided by paying special attention to specified and implied tasks in planning and to the desired end state during both planning and execution. Implied tasks especially are subject to interpretation and require thorough examination to conform to higher-level intent.

1-63. If the commander and staff have conducted a complete mission analysis, taking into account the interim and potential political end states, they will have identified all the current and potential tasks the command might perform. As the end state is clarified or matures, some of these potential tasks may become reality. Mission creep should be a rare occurrence.

NONCOMBATANTS

1-64. Noncombatants are a defining characteristic of most modern military operations. Their presence is unavoidable because in most cases their welfare is the reason for the operation. Noncombatants in stability operations and support operations can create various challenges. Local populations may be friendly, hostile, or indifferent to the presence of Army forces. In some cases, Army forces may have difficulty differentiating between hostile and nonhostile persons.

NONGOVERNMENTAL ORGANIZATIONS

1-65. The very conditions that may necessitate a stability operation or support operation—widespread human suffering, population movements, famine, human rights violations, and civil war—are also the conditions that attract the services of NGOs. Commanders must be prepared to coordinate their efforts with a myriad array of international organizations and NGOs. Each

organization or agency has a different mandate, set of capacities, organizational design, and cultural orientation. An operation's success may depend on how well the commander can forge productive working relationships with all these disparate bodies.

INFORMATION INTENSITY

1-66. All military operations are information intensive. In stability operations and support operations, this is further complicated by the numerous governmental and nongovernmental agencies involved. The scope and scale of required coordination and communication also complicate the operation. The cascading effects of events and their global magnification through the media further exacerbates this characteristic of the environment. Army forces can master this environment, in part, by gaining and maintaining information superiority through effective employment of information operations (IO). See Chapter 2 and FM 3-13 for discussion of IO and its components.

1-67. The presence of the media also impacts these operations. The news media can greatly influence how the public perceives an operation. Army forces must be prepared for contact with the media in their area. The media's need to disseminate as much accurate information as possible and to have access to the places where news exists must be balanced with operations security considerations.

CONSTRAINTS

1-68. Constraints are present in all military operations; stability operations and support operations are not an exception. Constraints may arise for many reasons and may be imposed on military forces by the chain of command or by the complex nature of the environment. Army forces in these actions must typically contend with constraints such as force caps, restricted activities, restricted areas, and specific ROE.

CROSS-CULTURAL INTERACTION

1-69. Interacting with other cultures can create a significant challenge during stability operations and support operations. Often, adjustments in attitudes or methods must be made to accommodate different cultures. Ethnocentrism and cultural arrogance can damage relationships with other forces, NGOs, or indigenous populations. The welfare and perceptions of indigenous populations are often central to the mission during stability operations and support operations. Army forces must establish good working relations with indigenous populations. Mutual trust and rapport increase the chances for mission success.

1-70. Army personnel should understand the culture and history of the area. Historical understanding helps soldiers comprehend the society, interact with the people in that society, and adapt to cultural differences to facilitate rather than impede mission accomplishment. Historical and cultural understanding help to determine the range of actions acceptable in solving the problem at hand. With this in mind, soldiers must receive cultural and historical orientations to the people and the conflict. Civil affairs units produce area studies that can provide this information. Interpreters, translators, and linguists are also invaluable.

FOUNDATIONS

1-71. Understanding the principles of war and tenets of Army operations is fundamental to operating successfully across the range of military operations. The principles of war and tenets of Army operations form the foundation of the Army's operational doctrine.

PRINCIPLES OF WAR

1-72. As in all operations, the principles of war outlined in FM 3-0 apply to stability operations and support operations. The situation determines their degree of applicability.

Objective

1-73. ***Direct every military operation toward a clearly defined and attainable objective.*** Commanders in any operation direct efforts toward clearly defined, decisive, and attainable objectives that will achieve the end state. In stability operations and support operations, the military objectives associate more directly with political objectives than is the case in offensive and defensive operations. Political authorities do not relinquish active participation and continue to exert considerable influence on the daily execution of the military campaign. Political objectives by their nature are not static and will be modified in response to dynamic domestic and international realities. Commanders must be adaptive and flexible to adjust their objectives. This requires that commanders maintain situational understanding of the political environment and participate in the process. Commanders must anticipate and understand the strategic aims. They must set appropriate military objectives, end states, and criteria for success. Commanders can achieve transparency by ensuring that other governmental and nongovernmental agencies and the local population understand the military objectives.

1-74. In stability operations and support operations, the military objective usually supports another agency. The selected course of action must align with political constraints and contain an acceptable amount of risk. This type of action may use military personnel and materiel to support a civilian agency that has overall responsibility. This agency establishes priorities and determines how to use military resources. The combination of means to be used and the role of each are political decisions. Changing political realities shape military missions. See Political Objectives discussed earlier in this chapter.

1-75. Military leaders cannot divorce objective from considerations of *restraint* and *legitimacy*. This is particularly true in stability operations and support operations. The amount of force applied to obtain the objective must be prudent and appropriate to the strategic aim. The military objective generally seeks to obtain the willing acceptance of a lawfully constituted agency, group, or government by the population in the AO. Without restraint or legitimacy, support for military action deteriorates and the objective becomes less obtainable. Legitimacy in peace operations is critical to achieving the consent of the parties to the conflict. US forces must be accepted as acting under the authority, and in the interest of, the accords or agreement.

1-76. To accomplish the mission, commanders *persevere*. Offensive and defensive operations may swiftly create the conditions for short-term success, but

protracted stability operations and support operations may be required to cement lasting strategic objectives. Commanders must balance their natural desire to enter the AO and accomplish the mission quickly with the need to depart only after having achieved the national goals and objectives.

Offensive

1-77. ***Seize, retain, and exploit the initiative.*** Diplomacy or political power takes decisive action in peace and conflict from the economic, informational, and military instruments. At the strategic level, military operations are usually defensive. They are intended to protect and assist political, economic, and informational activities. Military forces engage in the offense to accomplish a breakthrough in the political process, such as in peace enforcement, strikes, and raids. The strategic offensive may also include military actions intended to seize the initiative without necessarily resorting to violence. These actions include increased states of alert, mobilization of reserves, and strategic deployments. These actions may also make the threat of retaliation more credible. At the tactical level, offensive operations accomplish short-term objectives. They are conducted as in war, but under more restrictive ROE.

Mass

1-78. ***Concentrate the effects of combat power at the decisive place and time.*** Overwhelming combat power used as a show of force can prevent a potential enemy from mobilizing against US and multinational forces. At the tactical level, mass can quickly end violence. Mass may also apply to using political, informational, and economic power to have a decisive effect.

Economy of Force

1-79. ***Allocate minimum essential combat power to secondary efforts.*** As in war, military forces in stability operations and support operations use their capabilities in the most effective and economical way. In a strategic sense, most stability operations and support operations constitute an economy of force since they provide an alternative to war for promoting and protecting American national interests.

Maneuver

1-80. ***Place the enemy in a disadvantageous position through the flexible application of combat power.*** At the tactical level, maneuver applies in stability operations and support operations as it does in war. At the operational and strategic levels, the psychological aspects of maneuver take on greater importance. For example, in a peacekeeping operation, the timely arrival of the reserve can defuse a dangerous situation. Maneuver is more than just fire and movement. It includes the dynamic, flexible application of leadership, firepower, information, and protection as well.

Unity of Command

1-81. ***For every objective, ensure unity of effort under one responsible commander.*** The joint, multinational, and interagency nature of unified action creates situations where the military commander does not directly

control all elements in the AO. In the absence of command authority, commanders cooperate, negotiate, and build consensus to achieve *unity of effort*.

1-82. Stability operations and support operations require the combined efforts of all the instruments of national power. Many agencies and armed forces of the US and friendly foreign governments work together toward a common end state. NGOs often possess unique and valuable capabilities that can contribute to mission success. Commanders should try to ensure that all these organizations work together, without wasteful redundancies. This requires unity of effort, even when unity of command may not be achievable.

1-83. Another agency may direct and coordinate the total national effort as determined by the president. Decisive action is often in the hands of civilian policy makers, with the armed forces in a secondary and supporting role. During operations in which the Army is not the lead agent, operational and tactical headquarters plan their operations to complement those of government or private agencies. The challenge is to coordinate and integrate activities down to the lowest echelon possible. Consistent with OPSEC requirements, headquarters make their plans and actions clear to other agencies.

1-84. Army forces facilitate unity of effort by providing liaison elements, planning support, advisors, and technical experts. Additional personnel are normally required in these operations to serve in positions such as coalition support teams or liaison officers. Emphasis should be placed on the early establishment of contact with key organizations, including existing international organization and NGO coordination facilities and lead agencies of each sector. By maintaining constant contact, commanders see where their objectives and plans complement, or run counter to, those of other key agencies.

1-85. Commanders should establish or participate in coordination or operations center activities. These activities take place with multinational partners or nongovernmental organizations. These centers should ideally include representatives from all major agencies or contingents involved. These centers should be clearing houses to coordinate activities and resources to synchronize the effort. Additionally, joint military commissions are bodies of individuals representing the military force, various factions, and institutions involved in the conflict or its resolution. Joint military commissions are useful structures that solve problems at the lowest level. If available, a country team may facilitate coordination at the host-nation level. (For additional coordination considerations, see Appendix A, FM 3-16, and JP 3-08.)

1-86. There is precedent for a single directive authority over civilian and military organizations. The Civil Operations Revolutionary Development Support (CORDS) organization of the Vietnam War was a successful grouping of US civilian and military agencies under a single command. However, CORDS was the exception. Usually, unity of effort requires cooperation, negotiation, and consensus building. When the US effort is part of a multinational coalition, unity of command is even more difficult to achieve. Anytime the Army operates in negotiated coordination with an NGO, it does so without having directive authority over that organization.

1-87. The Army must initiate cooperative efforts with participating civilian agencies. It should determine their needs, offer its services, and provide expert advice. It should explain its capabilities and limitations. In some

situations, the Army must accept missions and priorities developed by consensus. Primary coordination will occur at the combatant command or joint task force level, but there is scope for negotiated support agreements within policy guidelines even at the lowest tactical levels.

Security

1-88. ***Never permit the enemy to acquire an unexpected advantage.*** The environment of stability operations or support operations can appear benign, especially in peacetime. When soldiers aim to help others and avoid violence, they may be lulled into complacency. This is when terrorist attacks or other forms of violence are most dangerous. Commanders must stay aware of the constant possibility of attacks on soldiers and always maintain the appropriate security posture. Force protection is an important command responsibility at all levels (see discussion of Force Protection in Chapter 2). A lapse of security in a tactical operation that results in casualties can significantly affect strategy by influencing domestic populations and policy makers. Keeping an impartial attitude while maintaining an appropriate defensive posture enhances security.

Surprise

1-89. ***Strike the enemy at a time, place, or in a manner for which he is unprepared.*** As in warfighting, surprise in stability operations and support operations consists of presenting an opponent with something he does not expect. In stability operations and support operations, this may be an ambush or raid. It may also be a political or informational initiative that denies the opponent an important issue. Commanders must carefully consider surprise when conducting peace operations. Transparency is a key fundamental that could be compromised by the element of surprise.

Simplicity

1-90. ***Prepare clear, uncomplicated plans and clear, concise orders to ensure thorough understanding.*** As in all operations, the less complicated the plan and the operation, the greater the likelihood of success. Overly complex operations are an invitation for failure.

TENETS OF ARMY OPERATIONS

1-91. The tenets of Army operations build on the principles of war. They further describe the characteristics of successful operations and are as applicable to stability operations and support operations as offensive and defensive operations.

Initiative

1-92. ***Initiative is setting or dictating the terms of action throughout the battle or operations*** (FM 3-0). In stability operations, initiative contributes to influence over factions. It establishes conditions conducive to political solutions and disrupts illegal activities. For instance, commanders may establish conditions under which belligerents can best achieve their interests by remaining peaceful. Exercising initiative means defusing

complicated crises, recognizing inherent dangers, and resolving grievances before they escalate.

1-93. To gain and maintain the initiative in support operations, commanders develop an understanding of the situation and anticipate requirements. Doing these things allows massing of resources to mitigate and prevent the effects of disasters. Commanders can then contribute to relieving suffering, managing consequences, and providing essential services.

Agility

1-94. ***Agility is the ability to move and adjust quickly and easily*** (FM 3-0). Operational agility stems from the capability to deploy and employ forces across the range of military operations. Army forces and Army commanders shift among offensive, defensive, stability, and support operations as circumstances and missions dictate.

1-95. Tactical agility is the ability of a friendly force to react faster than the enemy does. In stability operations and support operations, the commander must anticipate conditions and events so that preemptive or responsive action may be taken.

1-96. Stability operations and support operations can expand the range of operations into unfamiliar areas. They often present the commander with challenges for which there are no prescribed solutions. Success depends on the ability of the commander and his force to adapt structures and methods to accommodate new situations. *Adaptability* is meeting changing situations with flexibility and initiative. *Flexibility* is the ability to avoid dogmatic responses and to “bend” as each situation demands—to be receptive and responsive—without losing orientation.

Depth

1-97. ***Depth is the extension of operations in time, space, and resources*** (FM 3-0). In stability operations and support operations, depth extends the influence in time, space, purpose, and resources to affect the environment and conditions. Intelligence, surveillance, and reconnaissance combined with information operations allow commanders to understand the motives of factions, identify centers of power, and shape the environment in stability operations. In support operations, depth of resources, planning, and time allows commanders to stop the suffering and prevent or slow the spread of disease. In all offensive, defensive, stability, and support operations, staying power—depth of action—comes from adequate resources.

Synchronization

1-98. ***Synchronization is arranging activities in time, space, and purpose to mass maximum relative combat power at a decisive place and time*** (FM 3-0). Synchronization concentrates effects. In stability operations and support operations, synchronization allows the commander to focus the effects of not only combat power, but resources as well. Synchronization can create a synergistic effect that affords the commander greater legitimacy, influence, and control.

Versatility

1-99. *Versatility is the ability of Army forces to meet the global, diverse mission requirements of full spectrum operations* (FM 3-0). Competence in various missions and skills allows Army forces to transition from one type of operation to another, quickly and with minimal changes to the deployed force structure. Versatility is a prerequisite of multifunctional units. Military police, for example, can provide a mobile, lethal show of force, restore civil order, process detainees, and support peacekeeping operations.

Chapter 2

Planning Considerations

The measure of a good plan is not whether execution transpires as planned but whether the plan facilitates effective action in the face of unforeseen events.

FM 3-0

Commanders plan for stability operations and support operations in a manner like they plan for the offense and defense. The mission analysis and command estimate processes outlined in FM 5-0 are equally as important in all types of operations. Analysis using the tactical task areas outlined in FM 7-15 is helpful in focusing the planning effort. Many considerations discussed in this chapter also apply to offensive and defensive operations. However, they appear because the degree or manner in which they apply in these operations differs.

MANUEVER

2-1. The possibility of combat may be remote in some types of stability operations and support operations. In other operations, such as peace enforcement, combatting terrorism, noncombatant evacuation operations (NEOs), support to insurgency, support to counterdrug operations, and foreign internal defense—combat may be required. Commanders should always plan to have

CONTENTS	
Maneuver	2-1
Intelligence, Surveillance, and	
Reconnaissance.....	2-2
Human Intelligence	2-3
Counterintelligence Operations	2-4
Surveillance and Reconnaissance	2-4
Priority Intelligence Requirements	2-4
Nontraditional Databases.....	2-5
Requirement to Continuously Monitor	
Targets	2-5
Intelligence Synchronization	2-5
Split-Based Operations	2-5
Mapping	2-5
Fire Support.....	2-6
Lethal Capabilities	2-6
Nonlethal Capabilities	2-7
Air Defense	2-7
Mobility/Counter mobility/Survivability	2-8
Combat Engineer Support.....	2-8
General Engineer Support.....	2-9
Chemical Units	2-9
Logistics and Combat Service Support..	2-10
Importance of Nonstandard	
Logistics.....	2-10
CSS to Other Agencies.....	2-11
Combat Health Service Support	2-11
Resource Management.....	2-11
Command and Control	2-12
Command Relationships	2-12
Information Management	2-12
Other Planning Considerations	2-13
METT-TC Analysis.....	2-13
Civil-Military Operations.....	2-15
Protection.....	2-16
Information Operations	2-19
Deployment and Redeployment	2-20

the right mix of forces available to quickly transition to combat operations or evacuate. Additionally, when conducting these operations, commanders must consider the feasibility and means of redeployment—possibly to another theater—to conduct other operations.

2-2. These operations may involve a higher proportion of combat support (CS) and combat service support (CSS) forces than are employed to support offensive and defensive operations. In general, CS and CSS forces may have an increased role because of their unique capabilities and the specific mission requirements of these operations. CS and CSS elements may provide the base force or be the only forces employed in some operations.

2-3. Maneuver warfare and the applications of direct fires in support of it do not lend themselves to all forms of stability operations or support operations, particularly peacekeeping, foreign humanitarian assistance, and support to civil authorities. On the other hand, armored forces and attack helicopter assets may play major roles in preventive deployments and peace enforcement. These assets could be useful in other operations for force protection, deterrence, and convoy escort; for personnel transport where threats exist; or as a mobile reserve.

2-4. Mobility operations improve the movement of units, equipment, and supplies. The friendly force must have freedom of movement in all types of operations. However, in stability operations and support operations, mobility operations may allow civilian traffic and commerce to continue. Resuming the normal civilian activity in an area can be an important objective in an operation. In stability operations, mobility focuses on keeping lines of communications (LOCs) open and on reducing the threat of mines and other unexploded ordnance to soldiers and civilians. In support operations, mobility may focus on removing storm debris or reducing obstacles placed during a civil disturbance.

2-5. Army commanders in stability operations and support operations maintain adequate reserves. The reserve is sufficiently armed, trained, equipped, mobile, and positioned to accomplish its mission. A properly task-organized reserve expands each commander's ability to respond to unexpected successes and reversals. They require forces and resources specifically earmarked and available for contingencies. Maintaining reserves in these operations is often difficult. Most policy makers and commanders at all levels reluctantly commit more than the minimum to their reserve when conducting stability operations and support operations. Nonetheless, commanders understand that contingencies may arise that require using the reserve. The maintenance of a reserve allows commanders to plan for worst-case scenarios, provides flexibility, and conserves the force during long-term operations.

INTELLIGENCE, SURVEILLANCE, AND RECONNAISSANCE

2-6. Intelligence, surveillance, and reconnaissance (ISR) operations allow units to produce intelligence on hostile or neutral forces in the area of operations, as well as the environment (to include weather, terrain, and civil considerations) necessary to make informed decisions. This intelligence answers requirements developed throughout the military decision making process and the execution phase of the operation. Timely and accurate

intelligence encourages audacity and facilitates identifying and exploiting opportunities. Normally, timely and accurate intelligence depends on aggressive and continuous reconnaissance and surveillance.

2-7. Stability operations and support operations demand greater attention to civil considerations—the political, social, economic, and cultural factors in an area of operations (AO)—than do the more conventional offensive and defensive operations. Commanders must expand intelligence preparation of the battlefield beyond geographical and force capability considerations. The centers of gravity frequently are not military forces or terrain but may be restoring basic services or influencing public support. Cultural information is critical to gauge the potential reactions to the operation, to avoid misunderstandings, and to improve the effectiveness of the operation. Changes in the behavior of the populace may suggest a needed change in tactics or even strategy. Biographic information and leadership analysis are key to understanding adversaries or potential adversaries, their methods of operation, and how they interact with the environment. Knowledge of the ethnic and religious factions in the AO and the historical background of the contingency underlying the deployment are vital to mission success, preventing mission creep, and ultimately achieving the objectives of the operation.

2-8. Stability operations and support operations require intelligence operations to focus on developing a clear definition, understanding, and appreciation of all potential threats, to include disease and injury. Success in these operations requires multidisciplined, all-source, fused intelligence. A single-source approach cannot support all requirements. Thorough mission analysis allows commanders to tailor their intelligence capabilities to fit the mission's requirements. Commanders adapt tactically to select the intelligence capabilities needed. They often use human intelligence (HUMINT) and counterintelligence.

HUMAN INTELLIGENCE

2-9. In stability operations and support operations conducted outside the United States (US), HUMINT may provide the most useful source of information. Interpreters, low-level source operations, debriefs of indigenous personnel, screening operations, and patrolling are primary sources for assessing the economic and health needs, military capability, and political intent of those receiving assistance who or are otherwise a party to the contingency. Commanders should emphasize to all personnel the importance of always being intelligence conscious and should provide basic guidelines to improve their intelligence-gathering capability. Medical personnel must be aware of the Geneva Convention restrictions against medical personnel collecting information of intelligence value except that which is observed incidentally while accomplishing their humanitarian duties.

2-10. HUMINT is particularly important in support for counterinsurgency, counterterrorism, and counterdrug operations. FM 2-91.1 provides techniques such as pattern and link analysis that aid in HUMINT analysis.

COUNTERINTELLIGENCE OPERATIONS

2-11. Counterintelligence is active in stability operations and support operations even if no well-defined threat exists. Adversary HUMINT efforts focus on gaining access to US military personnel and operations information by providing services such as laundry and cooking. Or they may attempt to exploit members of the local populace who interact with US forces. Counterintelligence (CI) personnel develop an estimate of the threat and recommend appropriate actions. During multinational and interagency operations these personnel establish procedures and safeguards for the protection, handling, and release of classified or sensitive information to the forces of other nations and to supported elements. Essential elements of friendly information must be safeguarded to protect the force. During multinational operations, commanders must be alert that a coalition partner may conduct covert intelligence operations against US forces. CI operations must deal with this possibility in a sensitive way and, if possible, without offending partners.

SURVEILLANCE AND RECONNAISSANCE

2-12. Surveillance and reconnaissance may be employed to determine the disposition, activities, and intentions of civilian populations (hostile and neutral) and uniformed or irregular threats. Reconnaissance for information collection and security continues throughout the operation. Success requires integrating all available information from civil and military sources. In foreign humanitarian assistance operations, reconnaissance helps determine how and where to effectively apply limited assets to benefit the most people. Units conducting domestic support operations conduct reconnaissance to help determine when and where to apply manpower and resources. Forces conducting domestic support operations must know the legal limitations when acquiring information on civilians. (FM 3-55 further discusses reconnaissance.)

2-13. In many instances international organizations and nongovernmental organizations (NGOs) will have been in the area of operations long before US forces. These organizations produce reports, have web sites, and maintain databases of immense value. In the case of mines or unexploded ordnance, there is often a global positioning system reference collection of minefield survey data. US forces can access much of this information before deploying. Although commanders may access this information using intelligence operations, sound civil-military coordination may be a more effective approach. Nonmilitary organizations can provide valuable information; however, they may resent being considered a source of intelligence. Because of the nature of their work, some organizations must remain independent and nonaligned with any military force. Commanders foster communications and share valuable information with these organizations to become familiar with cultures and sensitivities of the local population. Sharing relevant information is an element of information management (see Command and Control later in this chapter) and not ISR.

PRIORITY INTELLIGENCE REQUIREMENTS

2-14. Priority intelligence requirements (PIR) in stability operations and support operations may differ from those in offensive and defensive operations. In combat operations, PIR focuses on the enemy's military capability and

intentions. However, intelligence collection in stability operations and support operations may adjust to the people and their cultures, politics, crime, religion, economics, and related factors, and any variances within affected groups of people.

2-15. Generally, in offensive and defensive operations, PIR are answered and targets are attacked and destroyed. In stability operations and support operations, collection and production to answer PIR may be ongoing tasks. For example, PIR related to treaty verification or force protection may continue as long as the mission requires.

NONTRADITIONAL DATABASES

2-16. In addition to traditional databases, nontraditional databases may be developed to address varied needs such as police checkpoints, storage sites, license plates, personalities, treaty compliance, site declarations, and mass gravesites. The staff updates databases daily. Databases also have enough flexibility for commanders as well as others to use them rapidly.

REQUIREMENT TO CONTINUOUSLY MONITOR TARGETS

2-17. Targeting guidance may require developing targeting data on numerous targets that may not be attacked but remain valid targets. The requirement to continuously monitor targets and update targeting data can create large databases requiring major effort.

INTELLIGENCE SYNCHRONIZATION

2-18. In addition to their organic assets, collection managers must be able to synchronize their collection efforts with a broad range of collection assets operating in the AO over which they have no direct control. These assets may include CI and HUMINT collection teams under control of another agency; signals intelligence and imagery intelligence collectors under control of a joint task force (JTF); and collectors under the control of friendly elements such as the host nation or coalition.

SPLIT-BASED OPERATIONS

2-19. There is increased reliance on split-based intelligence operations in stability operations and support operations. They help overcome certain constraints that are often present, such as force caps and limited lift availability. They allow commanders to deploy their force into an area and still receive continuous, relevant, and timely intelligence and electronic warfare support during all stages of the operation. Split-based operations use direct broadcast technology from collection platforms, assured intelligence communications, and small deployable intelligence support elements. Intelligence organizations outside the AO push intelligence forward and simultaneously receive PIR and request information for collection and processing.

MAPPING

2-20. Map coverage can be a significant challenge in any operation. In these operations, because they are often conducted in unanticipated areas with multinational forces or nonmilitary agencies participating, standardized map

coverage significantly aids in the planning and conduct of operations. The accuracy, scale, and currency of foreign maps may vary widely from US products. Consideration should be given to releasing US map data to other agencies and organizations as soon as possible. Release of US mapping materials may require foreign disclosure approval. (FM 2-91.1 includes tactics, techniques, and procedures for the roles, responsibilities, and activities of intelligence support in these operations.)

FIRE SUPPORT

LETHAL CAPABILITIES

2-21. Fire support assists commanders in carefully balancing deterrent force with combat power to accomplish the stability operation or the support operation and to protect the force. Precision munitions provide the commander with an important capability. Mortars, artillery, and special aircraft can provide illumination for demonstrating deterrent capability, for observing congested areas, for supporting friendly base security, or in support of patrolling maneuver forces.

2-22. Artillery fires, in particular rockets and rounds with ordnance (though relatively selective and accurate), involve a significantly higher possibility of collateral damage. In addition, unexploded ordnance can pose a safety hazard to the indigenous population and provide a local combatant with the foundation for an explosive device. Commanders should cautiously use conventional artillery fires. They should also carefully select munitions to minimize collateral damage and the threat to both friendly forces and local populations.

2-23. Field artillery howitzers and rocket systems provide both continuous deterrents to hostile action and a destructive force multiplier for commanders. To deal with an indirect fire threat, the force may locate hostile indirect fire systems using counterfire radars. The information generated can be used to document violations of cease-fire agreements and fix responsibility for damage and civilian casualties.

2-24. AC-130 aircraft, attack helicopters, and observation or scout helicopters are important target acquisition, deterrent, and attack assets in stability operations. Tactical air (TACAIR) can provide selective firepower, particularly in employing precision-guided munitions. Collateral damage and unexploded ordnance are significant planning factors when commanders consider using TACAIR.

2-25. Fire support coordination, planning, and clearance demands special arrangements with joint and multinational forces and local authorities. These arrangements include communications and language requirements, liaison personnel, and established procedures focused on interoperability. The North Atlantic Treaty Organization (NATO) standardization agreements (STANAGs) provide excellent examples of coordinated fire support arrangements. These provide participants with common terminology and procedures. Rules of engagement (ROE) should provide guidelines for clearing indirect fires (both lethal and nonlethal).

2-26. In general, commanders apply firepower with great restraint in these operations and consider restrictive ROE developed to fit the situation.

Specifically, with respect to fire support systems, even the most accurate of these weapons have extensive killing power, can injure or kill noncombatants, and may unnecessarily destroy property. Firepower is most often employed or displayed in operations that approach the threshold of war such as shows of force, demonstrations, and peace enforcement.

NONLETHAL CAPABILITIES

2-27. Nonlethal capabilities extend the range of firepower options. They augment means of deadly force. They are particularly valuable in both stability operations and support operations as they enhance the ability to apply force in proportion to the threat and allow discrimination in its use. They expand the number of options available to confront situations that do not warrant using deadly force but require soldiers to use overwhelming, decisive power to accomplish their missions. Many capabilities exist that create nonlethal effects on personnel or materiel. Such capabilities include, but are not limited to, irritants—such as CS, nonpenetrating projectiles, high-pressure water devices, smoke, and obscurants—and military working dogs. Nonlethal capabilities must show military necessity, must be used proportionally, and must not result in unnecessary suffering. Additionally, using riot control agents to counter domestic disturbances requires prior presidential approval. (See Appendix B for guidance on riot control agents.) The Military Police Corps is the Army's proponent on the training and employment of nonlethal munitions. FM 3-19.15 and FM 3-19.40 detail the characteristics and use of nonlethal munitions.

2-28. Military deception, psychological operations (PSYOP), electronic warfare, counterpropaganda, and computer network attack illustrate elements of offensive information operations (IO) that commanders use as nonlethal means to target adversaries in stability operations and support operations. (See Information Operations later in this chapter and FM 3-13.)

AIR DEFENSE

2-29. Stability operations require forces to be thoroughly trained on passive and active air defense measures. Soldiers must train in aircraft recognition and ROE since more than one of the forces involved may fly similar aircraft. Air defense considerations are more important in peace enforcement operations that enforce sanctions or deny or guarantee movement.

2-30. Adversaries may use extensive measures such as cover and concealment, hand-held surface-to-air missiles, and light air defense artillery weapons to protect themselves from air attack. Since many targets will be in belligerent-controlled areas, commanders must weigh the potential loss rate of aircraft against the returns that air interdiction missions might produce. However, they should also consider that curtailing rotary and low-level, fixed-wing operations may be one of the goals of the belligerent. Commanders must also consider a belligerent's use of unconventional air defense tactics, such as using rocket-propelled grenades against helicopters.

2-31. Air and missile defense (AMD) forces protect US forces and installations from aerial threats and may be responsible for protecting the population and facilities of the host nation, NGOs, and international organizations. AMD

forces counter the aerial threat posed by helicopters; fixed-wing aircraft; cruise missiles; and tactical, intermediate, and intercontinental ballistic missiles. These threats may be used as the means to deliver chemical, biological, radiological, nuclear, and high-yield explosive payloads.

2-32. AMD sensors, and command and control elements, provide early warning against aerial attack, and they contribute to the common operational picture. Air defense assets are ideally suited to distinguish between friendly and belligerent aircraft over safe havens or in no-fly zones. Participation in these operations by nations with different types of aircraft and communications capability can make discriminating friendly aircraft difficult. AMD units may also assist in airspace control operations in stability operations and support operations.

MOBILITY/COUNTERMOBILITY/SURVIVABILITY

2-33. Military police, engineer, and chemical forces provide essential support during stability operations and support operations to ensure a mobile, survivable force. Planners consider all available capabilities, to include *other services*, multinational forces, contractors, and troop units (including reserve components). The latter requires greater reaction time than active components do. Planners consider the specific capability and availability of the units when building the force, along with leasable facilities and the infrastructure. The JTF contingency engineer manager normally provides staff assistance to the JTF commander (who controls engineer assets). Similar considerations apply to multinational forces.

2-34. Planners must consider interoperability to ensure that assets are complementary, if not compatible. Engineer planners also consider personnel or materiel assets available through contracts, local sources, and private agencies, including the logistics civilian augmentation program (LOGCAP).

2-35. Engineer operations require large amounts of construction materials that may be acquired locally, regionally, and from the continental United States. These materials may be obtained through military supply channels or by contract. Engineers identify, prioritize, and requisition required construction material consistent with acquisition regulations. Supply units process the requisition and acquire, receive, store, and transport construction materials. This support may also be provided through a combination of engineer unit Class IV acquisition and storage by LOGCAP contractor support.

COMBAT ENGINEER SUPPORT

2-36. Combat engineer support may be required in various stability operations, to include peace operations (PO), noncombatant evacuation operations, and foreign internal defense. This type of support falls under the categories of mobility, countermobility, and survivability, and includes such tasks as—

- Constructing command posts and bunkers.
- Constructing force protection structures such as earth revetments, wire obstacles, and fighting positions.
- Clearing fields of observation.
- Marking minefields, to include minefield fence maintenance.

- Demolishing fortifications.
- Clearing mines and debris from roads.
- Conducting route reconnaissance to support LOCs.
- Clearing mines, unexploded ordnance, and booby traps from buildings, vehicles, and other locations.
- Providing backup support for explosive and ordnance identification, marking, removal, or demolition.
- Providing technical expertise to maneuver forces.

GENERAL ENGINEER SUPPORT

2-37. Overseas, general engineering missions can assist the host nation by constructing facilities and supporting government or civil agencies. Engineers may also teach basic skills to indigenous civilian and military personnel and then work together on projects that support host nation institutional and infrastructure development. Domestically, engineers are integral to relief and recovery from disasters and emergencies. General engineering contributes to relief by—

- Assessing damages to structures, utilities, and so forth.
- Supporting search and rescue efforts with personnel and equipment.
- Clearing rubble areas, mud, or snow.
- Restoring critical facilities, services, and utilities.
- Demolishing unsafe structures.
- Providing emergency power to critical facilities.
- Constructing temporary bridges.
- Providing expedient repair of critical distribution systems.
- Cutting fire breaks with equipment, chain saws, and hand tools.

2-38. Combat engineer elements can provide general engineering to the force; however, most construction requires additional engineer units. The combat heavy and other specialized engineer units are most important for developing base camps, logistic facilities, roads, and airfields. Other examples of general engineering missions include building temporary shelters, locating potable water sources, drilling water wells, and repairing bridges.

CHEMICAL UNITS

2-39. Commanders must consider the requirement for chemical support if evidence exists that belligerent forces or terrorists have employed agents or have the potential for doing so. In addition, when authorized, riot control agents may be selectively employed as an alternative to deadly force. A mix of different units—decontamination units; nuclear, biological, and chemical (NBC) reconnaissance elements; and smoke units—are often necessary to properly balance capabilities. Additional capabilities include limited water transfer, spray, and storage. Chemical staff officers participating in the intelligence process advise the commander of commercial and industrial chemical threats.

LOGISTICS AND COMBAT SERVICE SUPPORT

2-40. Army CSS enables the commander to execute his mission and sustain the force. This is true throughout the range of Army operations. CSS forces may be employed in nonstandard tasks or in quantities disproportionate to their normal roles. Like all other elements, they must be capable of self-defense, particularly if they deploy alone or in advance of other Army forces. Army CSS is discussed in FM 4-0.

2-41. Because the logistic requirements in stability operations and support operations vary widely, mission analysis determines the proper CSS capabilities required. CSS assets are allocated based on those requirements. For example, it may be necessary to deploy additional material—such as tactical bridging and water purification equipment—to restore critical services and infrastructure. No standard arrangement fits all situations.

IMPORTANCE OF NONSTANDARD LOGISTICS

2-42. Host-nation support, contracting, and local purchases are force multipliers in many of these operations. Situations that lack optimal sustaining capabilities may require using nonstandard logistics. They may augment or replace existing CSS capability. They can reduce dependence on the logistic system, improve response time, and free airlift and sealift for other priority needs. Contracting personnel should precede the main body of Army forces if feasible. Nonstandard logistics may be employed for—

- Limited supplies such as Classes I, II, III, IV, and IX.
- Services such as catering, maintenance and repair, sanitation, and laundry.
- Rental services such as mobile communications.
- Transportation.

2-43. The LOGCAP is advanced acquisition planning to use civilian contractors during wartime and unforeseen military emergencies augmenting the Army combat support and combat service support capability. The LOGCAP objective is to preplan for the use of contractors to perform selected services to augment Army forces. See AR 700-137 for LOGCAP information.

2-44. Commanders can expect that contractors will be involved in stability operations and support operations. The management and control of contractors differs from the command and control of soldiers and Department of the Army (DA) civilians. During military operations, soldiers and DA civilians are under the direct command and control of the military chain of command. Commanders can direct soldier and DA civilian task assignment, special recognition, and disciplinary action. However, they do not have the same control over contractors. The terms and conditions of the contract establish the relationship between the military and the contractor. See FM 3-100.21 for specific considerations.

2-45. Commanders and staff planners must assess the need for providing force protection to a contractor and designate forces to provide security when appropriate. The mission of, threat to, and location of the contractor determines the degree of force protection needed. Protecting contractors involve not only active protection through the use of armed military forces to provide

escort or perimeter security, but also training and equipping of contractor personnel in self-protection (NBC and weapons). When the threat exists and the commander of a combatant command has granted approval, contractor personnel may be trained and equipped to work in an NBC environment. The same personnel may carry individual, military specification weapons for personal protection, provided the contractors' company policy permits and the employee agrees.

CSS TO OTHER AGENCIES

2-46. When directed, logistic assistance is provided to agencies other than the US military that lack the capability to sustain operations. Army CSS capabilities—such as transportation, supply, or medical services—often support other agencies, private organizations, and individuals during these operations. At the same time they continue to support friendly forces.

COMBAT HEALTH SERVICE SUPPORT

2-47. Combat health resources may be used across a broad spectrum of missions (from consulting to delivering health care) in stability operations and support operations. Due to Title 10 restrictions and the constraints imposed by the Geneva Conventions, the command surgeon, in conjunction with the staff judge advocate advises the commander on which groups of individuals are eligible beneficiaries to receive military health care and the methods of reimbursement for services rendered. In humanitarian assistance and disaster relief operations, the population served will differ from the traditional healthy and fit military force, and will be comprised of children; infants; and obstetrical, gynecological, and geriatric patients. The composition of the affected population will require augmentation of existing medical equipment sets with specialized equipment, instruments, and medicines. Consultation and advice may be required to assist the host nation in enhancing or developing the medical infrastructure, civilian medical programs, basic health and sanitation services, and animal husbandry programs.

RESOURCE MANAGEMENT

2-48. Many possible sources of funding exist in stability operations and support operations; legal restrictions often limit using these funds. Unauthorized expenditure of funds can lead to criminal or administrative action against those responsible. Some basic principles participants in these operations should be aware of include—

- Expenditures must be reasonably related to the purpose for which Congress made the appropriations.
- Expenditures must not fall specifically within the scope of some other category of appropriation (such as Title 10 Operations and Maintenance funds versus Title 22 Security Assistance Funds).
- If two appropriations permit the expenditure, either may be used, but not in combination or interchangeably to achieve the same objective. This is a prohibition against augmentation of funds.
- Upon mission receipt, resource managers must begin accounting for expenditures and tracking the use of CSS assets to capture costs of the operation for reimbursement. Financial accountability at all levels is

important for reimbursement and is legally required for reporting the costs of operations to Congress.

COMMAND AND CONTROL

2-49. Because stability operations and support operations tend to be joint, multinational, or interagency, they are often planned and conducted in concert with those outside the US military. As stated in Chapter 1, Army forces are often the supporting organization rather than the lead agency. However, the efforts of all involved must be coordinated toward a unified effort. Senior Army commanders devote much of their time and energy to the problems of coordination and cooperation. Commanders use liaison elements and coordination centers to facilitate unity of effort. (Appendix A discusses liaison and coordination centers.)

2-50. No single command and control (C2) option works best for all stability operations and support operations. Commanders should be flexible in modifying standard arrangements to meet specific requirements of each situation and to promote unity of effort.

2-51. When operating inside a multinational organization, commanders should expect to integrate units down to the company level for combat units, and to the individual level for support units. Commanders must train with this reality in mind. Units operate under established procedures modified to accord with the standing operating procedures for the alliance or multinational coalition. It is accepted that effectiveness will initially decrease when operating in a multinational force, but through training and understanding of standards and procedures, unit performance will improve.

2-52. One factor that distinguishes stability operations and support operations from offensive and defensive operations is the requirement for interagency coordination at the task force level and below. In interagency operations, Army commanders have inherent responsibilities including the requirements to clarify the mission; to determine the controlling legal and policy authorities; and to task, organize, direct, sustain, and care for the organizations and individuals for whom they provide the interagency effort. They also assure seamless termination under conditions that ensure the identified objectives are met and can be sustained after the operation.

COMMAND RELATIONSHIPS

2-53. The ground commander often executes the military portion of an interagency plan. He must know and understand the relationship that Army forces have with others participating in the operation.

2-54. Although the US can conduct stability operations and support operations unilaterally, it seldom pursues its national interests alone. Several options may be employed for the C2 of multinational forces including coalitions and alliances. See FM 3-16 for additional considerations in C2 in multinational operations.

INFORMATION MANAGEMENT

2-55. Information management is a critical C2 consideration during all operations. In stability operations and support operations, sharing of relevant

information with NGOs, local officials, police, and other non-military agencies will achieve effective coordination and unity of effort. Approaches to civilian organizations, including the media, for information should be open and transparent, including a clear statement of the use of the information. This will avoid undermining cooperative efforts with such agencies.

Information management is the provision of relevant information to the right person at the right time in a usable form to facilitate situational understanding and decision making. It uses procedures and information systems to collect, process, store, display, and disseminate data and information.

FM 3-0

2-56. Clarity and accuracy of information are critical, especially when involving multiple agencies in activities such as scheduling airlifts and processing resources. Information sharing is essential to establish ground truth—a critical and sensitive process. Not all agencies may agree on the nature or scope of support required or on the operation’s progress. To preempt false impressions, Army forces routinely share information with other agencies. Information sharing helps other agencies execute their missions. For example, providing overhead photography to relief officials can assist in the design and construction of needed refugee camps or aid search efforts. Data on the quantity and type of relief aid moved by various means can assist in the transportation planning of other agencies. Sharing information on the use of cluster munitions and other ordnance is needed to help establish safe routes for returning refugees and to protect the local population along with the international and nongovernmental organizations in the AO.

OTHER PLANNING CONSIDERATIONS

METT-TC ANALYSIS

2-57. The planning process outlined in FM 5-0 is valid for all operations. However, the nature of the environment in which forces conduct stability operations and support operations requires commanders and staff to view the six factors of METT-TC—mission, enemy, terrain and weather, troops and support available, time available, civil considerations—from a different perspective than when conducting offensive and defensive operations. Analyzing the factors of METT-TC is critical during the military decision making process (MDMP). The impact of each factor will differ from operation to operation, but each must be considered carefully in light of the operational environment:

- **Mission.** In stability operations and support operations, the missions may come from various sources. The operation order of a higher headquarters may not be the only source for mission analysis. Terms of reference, special agreements (such as the Dayton Accords for Bosnia-Herzegovina or the Military-Technical Agreement regarding Kosovo), status-of-forces agreements (SOFAs), ROE, status of mission agreements, and executive orders are examples of mandates and declarations that must be reviewed for mission requirements. A

comprehensive mission analysis is the best safeguard against mission creep (see discussion of Mission Creep in Chapter 1).

- **Enemy.** The characterization of *the enemy* is a critical concern in stability operations and support operations. For combat operations conducted in support of stability operations, such as forcible separation of adversaries during peace enforcement operations, the enemy is analyzed, as it would be for offensive and defensive operations. But for other operations, the concept of *enemy* could be much different. In PO, it is the conflict and not the parties to the conflict that is the enemy. In complex contingencies, it may be hunger or disease and not competing political factions that is the enemy. Forces conducting domestic counterdrug operations must carefully avoid characterizing the object of their surveillance as a military enemy. Commanders must guard against taking actions that would inadvertently create an enemy where there was not one. For example, the impression that one of the parties to a conflict is receiving favorable treatment could turn other parties against the PO forces (as in Lebanon when Shi'a forces attacked US Marines whom they saw as favoring the Maronite Christian-dominated government). See the discussion of Modified Concept of the Enemy in Chapter 1.
- **Terrain and weather.** The five military aspects of terrain—observation and fields of fire, avenues of approach, key terrain, obstacles and movement, and cover and concealment (OAKOC)—remain valid, but the way the commanders use these aspects to analyze the environment may require a different perspective. Decisive terrain may not be a hilltop or defile, but rather the attitude of the people or civil infrastructure. The impact of weather on civilians and the potential for a worsening humanitarian crisis may create unique concerns for commanders in stability operations and support operations.
- **Troops.** When considering troops available, commanders must expand their thinking to consider different sources of support to the mission. Many stability operations and support operations require a greater mix of combat support and combat service support units than do offensive and defensive operations. Multinational forces, other US government agencies, contractors, and host-nation civilians may be available to support the commander in accomplishing his mission. Commanders will also seek to coordinate and leverage the substantial contributions to the overall goals of the operation made by international and non-governmental organizations.
- **Time.** Commanders at all levels must consider the possibility of long-term commitment to some stability operations. As a result of the 1978 Camp David Accords, Army forces have been providing peacekeepers to the multinational forces and observers for more than 20 years. As a result of the 1995 Dayton Peace Accords, NATO-assigned US forces continue to enforce the peace in Bosnia after five years. Many support operations, such as disaster relief missions, only last a matter of weeks. Planners must anticipate long-term commitments that may require rotating units or individuals.
- **Civil considerations.** Civil considerations are important in all operations but are a critical concern in stability operations and support

operations. The primary purpose of many of these operations is improving the quality of life of the local populace, whether through mitigating the effects of disasters or creating a secure environment for social, economic, and political development.

CIVIL-MILITARY OPERATIONS

2-58. Military commanders must consider not only the military forces, but also the environment in which those forces operate. One factor of the environment that commanders must consider is the civilian populace and its impact—whether it is supportive, neutral, or hostile to the presence of military forces. A supportive populace can provide resources that facilitate friendly operations. It can also provide a positive climate for military and diplomatic activities that a nation pursues to achieve foreign policy objectives. A hostile populace threatens the immediate operations of deployed friendly forces and can often undermine public support at home for the nation’s policy objectives.

2-59. *Civil-military operations* (CMO) are the activities of a commander that establish, maintain, influence, or exploit relations between military forces, governmental and nongovernmental civilian organizations and authorities, and the civilian populace in a friendly, neutral, or hostile operational area in order to facilitate military operations, to consolidate and achieve operational US objectives. Civil-military operations may include performance by military forces of activities and functions normally the responsibility of the local, regional, or national government. These activities may occur prior to, during, or subsequent to other military actions. They may also occur, if directed, in the absence of other military operations. Civil-military operations may be performed by designated civil affairs, by other military forces, or by a combination of civil affairs and other forces (JP 3-57). The very nature of stability operations and support operations places our forces in direct contact with civilians, governments, and NGOs. This relationship makes CMO critical to any stability operation or support operation.

2-60. CMO have three objectives. CMO enhance military effectiveness by reducing interference with military operations by the civil population. They support our national objectives by encouraging the development of a country’s material and human resources. And lastly, CMO reduce the negative impact of military operations on civilians. Some support operations, such as domestic support operations and foreign humanitarian relief, are in and of themselves CMO. Some stability operations include civil-military activities in support of the larger mission and objective. For example, emergency civil administration conducted as part of a peace enforcement mission is a civil-military operation. JP 3-57 and FM 3-57 discuss specific CMO activities.

2-61. The G5/S5 is the principal staff officer for all matters concerning civil-military operations. The G5/S5 must enhance the relationship between military forces and civilian authorities and personnel in the AO. The G5/S5 is required at all echelons from battalion through corps level, but authorized only at division and corps levels. Once deployed, units below division level may be authorized an S5. (See FM 6-0.) The CMO staff may be augmented with civil affairs (CA) teams to assist in planning and executing CMO. CA forces are an essential element of CMO by virtue of their area and linguistic

orientation, cultural awareness, training in military-to-host nation advisory activities, and civilian professional skills that parallel common government functions.

PROTECTION

2-62. Protection is the preservation of the fighting potential of a force so the commander can apply maximum force at the decisive time and place. Protection has four components: force protection, field discipline, safety, and fratricide avoidance. Protection bears significantly on every aspect of stability operations and support operations. Commanders must take great pains to protect the force from attack. Adversaries opposed to US interests, or who seek to destabilize an area, will go to great lengths to expel US forces. They will employ terrorist tactics such as bombings, kidnappings, assassinations, ambushes, and raids. Commanders address force protection during planning and revise their plan as necessary during execution. (FM 3-07.2 provides a process by which commanders can assess the threat to the force and act to defeat that threat.) This does not mean that commanders must isolate their troops from contact with the indigenous population. Mission degradation, or even increased risk to the force, can result if commanders restrain forces from conducting prudent missions and establishing an active and capable presence in the area.

Force Protection

2-63. Because of unusual and uncertain threats associated with stability operations and support operations, force protection is a key consideration for commanders. Force protection consists of those actions to prevent or mitigate hostile actions against Department of Defense (DOD) personnel (to include family members), resources, facilities, and critical information. It minimizes the effects of enemy firepower (including weapons of mass destruction, maneuver, and information) (see FM 3-07.2). Commanders attempt to accomplish a mission with minimal loss of personnel, equipment, and supplies by integrating force protection considerations into all aspects of the operations process. But the commander must balance force protection measures against a “bunker mentality” in his force and diminishing interaction with the indigenous population. Force protection consists of air, space, and missile defense; NBC defense; antiterrorism; defensive IO; and local security to operational forces and means.

2-64. **Air, Space, and Missile Defense.** The commander must consider the use of air defense artillery forces if evidence exists of belligerent forces having the ability to employ fixed- or rotary-winged aircraft, unmanned aerial vehicles, or cruise missiles against any friendly forces, civilians, or NGOs he is obligated to protect. Stability operations in these situations require forces to be thoroughly trained on passive and active air defense measures. Visual aircraft recognition may be particularly challenging since more than one of the forces involved may use similar aircraft. Air defense considerations are more important in peace enforcement operations that deny or guarantee movement and safe passage or that enforce sanctions (see JP 3-10).

2-65. **NBC Defense.** NBC defensive measures provide the capability to defend against attack by nuclear, biological, and chemical weapons and to

survive and sustain combat operations in an NBC environment. Survival and sustainment must use the following principles: avoidance of NBC hazards, particularly contamination; protection of individuals and units from unavoidable NBC hazards; and decontamination. An effective NBC defense counters belligerent threats and attacks by minimizing vulnerabilities, protecting friendly forces, and maintaining an operational tempo that complicates targeting. By denying or countering any advantages that the adversary may accrue from using NBC weapons, Army forces and their multinational partners significantly deter their use.

2-66. **Antiterrorism.** *Antiterrorism* is the defensive measures used to reduce the vulnerability of individuals and property to terrorist acts, to include limited response and containment by local military forces (JP 1-02) (see JP 3-07.2 and Chapter 5). Terrorism may well be the most likely threat that Army forces will face when conducting stability operations and support operations. Commanders have an inherent responsibility for planning, resourcing, training, exercising, and executing antiterrorism measures to provide for the security of the command. Likewise, every soldier, DOD employee, independent contractor, and local national hired by DOD has an inherent responsibility to maintain vigilance for possible terrorist actions.

2-67. **Defensive IO.** See Information Operations in this chapter.

2-68. **Security.** At the operational level, rear area and base security contributes to force protection (see JP 3-10.1). Commanders should consider—

- **Sites, accommodations, and defensive positions.** Precautions should be taken to protect positions, headquarters, support facilities, and accommodations. These may include obstacles and shelters. Units must also practice alert procedures and develop drills to rapidly occupy positions. A robust engineer force can provide support to meet survivability needs. Units should maintain proper camouflage and concealment based on METT-TC. Additional information on precautions is provided in FM 3-34.112 and FM 3-06.
- **Roadblocks.** Military police (MP) forces may establish and maintain roadblocks. If MP forces are unavailable, other forces may assume this responsibility. Roadblocks can be used not only to restrict traffic for security purposes, but also to control the movement of critical cargo in support of humanitarian operations. As a minimum, the area should be highly visible and defensible with an armed overwatch.
- **Personnel vulnerabilities.** Forces are always vulnerable to personnel security risks from local employees and other personnel subject to bribes, threats, or compromise. The threat from local criminal elements is also a constant threat and force protection consideration.
- **Personal awareness.** The single most proactive measure for survivability is individual awareness by soldiers in all circumstances. Soldiers must look for things out of place and patterns preceding aggression. Commanders should ensure that soldiers remain alert, do not establish a routine, and maintain appearance and bearing.
- **Sniper threats.** In stability operations and support operations, the sniper can pose a significant threat. Counters include rehearsed responses, reconnaissance and surveillance, and cover and

concealment. ROE should provide specific instructions on how to react to sniper fire, to include restrictions on weapons to be used. Units can use specific weapons, such as sniper rifles, to eliminate a sniper and reduce collateral damage.

- **Security measures.** Security measures are METT-TC dependent and may include the full range of active and passive measures such as patrolling, reconnaissance and surveillance, and use of reaction forces.
- **Coordination.** Commanders should coordinate security with local military and civil agencies and humanitarian organizations when possible.
- **Evacuation.** Commanders must have a plan to evacuate the force should conditions warrant, such as war erupting during the conduct of a peacekeeping operations or a host nation withdrawing support for humanitarian assistance. This plan should include appropriate routes for ground, sea, or air evacuation. All units should rehearse their evacuation plan and develop contingency plans that cover such tasks as the breakout of an encirclement or the fighting of a delaying action. Operations security (OPSEC) is critical as public knowledge of such plans or witnessing of a rehearsal could erode the confidence of the local population and thus the legitimacy of the mission.

Field Discipline

2-69. Field discipline guards soldiers from the physical and psychological effects of the environment. Soldiers can adapt to the point where they outperform indigenous populations. Commanders take every measure and precaution to keep soldiers healthy and maintain their morale. Such actions include securing equipment and supplies from loss or damage. Commanders ensure that systems are in place for adequate health services to include preventive medicine and medical surveillance programs, stress control, and medical laboratory services. They provide effective systems for maintenance evacuation and rapid replacement or repair of equipment.

Safety

2-70. Commanders in stability operations and support operations may reduce the chance of mishap by conducting risk assessments, assigning a safety officer and staff, conducting a safety program, and seeking advice from local personnel. The safety program should begin with training conducted before deployment and continue throughout the deployment. Training will include factors that could affect safety such as the environment, terrain, road conditions, and local driving habits; access or possession of live ammunition; unlocated or uncleared mine fields; and special equipment such as tanks and other systems that present special hazards. Safety is also important during off-duty and recreational activities. If possible, the safety officer and staff should coordinate with local authorities concerning environmental and health concerns. The presence of US forces should not adversely impact the environment (see FM 5-19).

Fratricide Avoidance

2-71. Most measures taken to avoid fratricide in stability operations and support operations are the same as those measures taken during offensive and defensive operations. However, commanders must consider other factors such as local hires or NGO personnel that may be as much at risk as US forces. Fratricide avoidance is an important part of CMO; effective civil-military coordination and sharing of information will reduce fratricide and collateral damage. Accurate information about the locations and activities of both friendly and hostile forces (situational understanding) and an aggressive airspace management plan assist commanders in avoiding fratricide. Liaison officers increase situational understanding and enhance interoperability. Using night vision light-intensifier devices aids units in target identification during limited visibility. ROE might prevent soldiers from using some weapon systems and lessen the risk of fratricide. The collateral effects of friendly weapons in urban and restricted terrain can affect fratricide. Soldiers must know the penetration, ricochet, and blast consequences of their own weapons.

INFORMATION OPERATIONS

2-72. Information is at the very heart of many stability operations. In fact, IO may be designated as the main effort during certain phases of an operation. These operations are often sensitive and politically charged where perception and public support may be centers of gravity. In stability operations, IO may be the most critical and acceptable means of achieving stated objectives consistent with the ROE.

2-73. As an element of combat power, information plays a critical role in stability operations and support operations. IO will have an even greater relative importance given the reduced emphasis on firepower in stability operations and support operations. Refer to FM 3-13 for a more comprehensive and detailed discussion.

Offensive IO

2-74. *Offensive information operations* are the integrated use of assigned and supporting capabilities and activities, mutually supported by intelligence, to affect enemy decision makers or to influence others to achieve or promote specific objectives (FM 3-0). Offensive IO may impact more in stability operations and support operations because they promote legitimacy and reduce bias, ignorance, and confusion by persuading, educating, coordinating, or influencing. Soldiers, participants, and populations must understand the objectives and motives of friendly forces, as well as the scope and duration of friendly actions.

2-75. Public affairs and CMO are activities related to IO. Both communicate information to critical audiences to influence their understanding and perception of military operations. Related activities are distinct from IO because they do not manipulate or distort information; their effectiveness stems from their credibility with the local populace and news media. Public affairs and CMO—prime sources of information—link the force, the local populace, and the news media. They also provide assessments of how military operations impact civilians, neutrals, and others in the area of operations.

2-76. Adversaries and other organizations will use propaganda and disinformation against the force to influence the public. PSYOP and public affairs must work closely with the intelligence community to be predictive, rather than reactive, to such attacks. Public affairs personnel inform and counter the effects of propaganda and misinformation. FM 3-61 contains details on conducting public affairs activities. The command should establish mechanisms such as a joint information bureau and media working groups to educate as well as inform local and international media. An informed public, with accurate and timely information, is a force multiplier in stability operations and support operations.

Defensive IO

2-77. *Defensive information operations* are the integration and coordination of policies and procedures, operations, personnel, and technology to protect and defend friendly information and information (FM 3-0). IO are critical to preserving operations security and freedom of action. Protecting information is key to protecting the force and the mission. The need to be candid and responsive to requests for information must balance the need to protect operational information, such as troop movements, security plans, and vulnerabilities. Working closely with all parties, information operations planners must develop the essential elements of friendly information to preclude inadvertent public disclosure of critical or sensitive information.

2-78. A critical aspect of IO is the discovery of capabilities and intentions of potential adversaries and threats. In stability operations and support operations, such adversaries will use IO to integrate all elements of their power and capabilities to target friendly forces. The likely adversaries that US forces may face in these operations will not be concerned about information superiority and will seek only temporary advantages at critical points and times. They may see Western concepts of laws of conflict as an unnecessary handicap and be willing to use deception, trickery, civilian-run enterprise, or the media when implementing an IO campaign. Friendly forces should expect that adversary IO will include all venues and media that adversary leadership can manipulate, including—

- Adversary propaganda directed at friendly forces and propaganda for domestic consumption.
- Statecraft and public diplomacy used to generate media events that serve IO objectives.
- Censorship of domestic and international media as well as use of all media to transmit propaganda and false, misleading information to all audiences.

DEPLOYMENT AND REDEPLOYMENT

2-79. In stability operations and support operations strategic deployment and redeployment planning and execution considerations are the same as those for any other operation. However, some considerations deserve special emphasis.

Unit Preparation and Training

2-80. Warfighting skills developed and honed in training form the basis for mission success. Combat-ready units can adapt readily to noncombat situations, but units not trained to standard cannot survive in combat. The knowledge, discipline, cohesion, and technical skills necessary to defeat an enemy are also needed in environments that seem far removed from the battlefield. The combat capability of Army forces is the basis for all they do. In stability operations, the threat of force may deter escalation; in a support operation, it may preempt violence and lawlessness.

2-81. The mission essential task list (METL) development process remains the link between anticipated stability operations and support operations missions and predeployment training (see FM 7-0 and FM 7-1). In stability operations, close combat dominance is the principal means Army forces use to influence belligerent actions. The combat tasks, tactics, techniques, and procedures used in offensive and defensive operations are the same as those employed in stability operations. Peace operations, noncombatant evacuation operations, foreign internal defense, and show of force are some examples of stability operations where forces may be required to conduct combat tasks. However, the conditions and standards of performance for these tasks are modified by METT-TC considerations and the more restrictive ROE required in stability operations. Commanders use basic tactical concepts and control measures for offensive, defensive, stability, and support operations. (See FM 3-90.)

2-82. Although Army forces are not specifically organized, trained, or equipped for support operations, their warfighting capabilities are particularly suited to domestic support operations and foreign humanitarian assistance. Units trained for their wartime mission are disciplined with well-established, flexible, and adaptable procedures. Army units have a functional chain of command, reliable communications, and well-equipped organizations. They can operate and sustain themselves in austere environments with organic assets. They can move large forces to the affected area with organic transportation.

2-83. Army engineer, military police, medical, transportation, aviation, and civil affairs assets are especially valuable for support operations. Support operations often require the accomplishment of combat tasks. For example, a scout platoon establishing observation posts in support of counterdrug operations or combat engineers reducing obstacles after a natural disaster. Some missions require specialized training such as that provided by the National Interagency Fire Center to train soldiers in fighting forest fires. Many combat service support missions and tasks are the same across the entire spectrum of operations.

2-84. The major Army command, Army service component, continental US Army, and corps commanders determine the battle focus, resources, and METL that maintain the required readiness posture for anticipated operations in war or military operations other than war. For planned stability operations and support operations, unit commanders may adjust their battle-focused training to reflect the unique aspects of these operations. For units deployed to conduct stability operations or support operations with little or

no preparation, their warfighting competencies will sustain them as they adjust to the stability operation or support operation.

Time-Phased Force and Deployment Data

2-85. The primary challenge for commands executing deployment or redeployment in stability operations and support operations is developing the time-phased force and deployment data (TPFDD). The TPFDD is critical to refine, validate, and coordinate movement requirements for the force. Unit movement officers must prepare and submit TPFDD through their higher headquarters for the supported combatant commander's validation. Once movement requirements and priorities are validated, the supported combatant commander submits the requirement to the US Transportation Command for scheduling. For support operations in the continental United States, TPFDD validation rests with US Army Forces Command in its role as lead operating agent for US Joint Forces Command. Non-DOD movement requirements and priorities for US domestic disaster relief operations are forwarded through the federal coordinating officer appointed by the Federal Emergency Management Agency to the appropriate defense coordinating officer. FM 3-35 and JP 3-35 further explain deployment and redeployment.

Predeployment Survey

2-86. Before deploying the advance party, a predeployment survey team should move to the location of future operations. The team should be resourced to effectively perform coordination and reconnaissance and to provide information to elements conducting planning. At a minimum, the team should include the officer in charge and appropriate personnel from the specialties of operations, intelligence, logistics, and communications. Depending on the situation, commanders may also consider sending engineer, medical, air liaison, public affairs, PSYOP, civil affairs, legal, explosive ordnance disposal, and unit ministry personnel. This team should include personnel from other US agencies, such as the US Agency for International Development, and may include allied personnel. The United Nations (UN) and specialized agencies will also conduct surveys. Commanders should consult these and other organizations (typically including NGOs) with detailed knowledge of the area.

Transition

2-87. Multinational and multiagency operations will normally require the handover of AOs and responsibilities to other military forces, governmental agencies, or NGOs. Similar to a relief, the military force will carefully plan, coordinate, and manage the transition to the relieving force or agency. The units involved will present a seamless transfer of responsibility, both for efficiency and effectiveness and to prevent any divergence or discrepancy that an adversary may exploit. Planning for transition should begin before deployment and the assumption of the mission. Only through multinational, political-military planning can a proper transition be conducted.

2-88. Transitions between units in offensive and defensive operations are usually reliefs in place focused on units and areas of responsibility. A relief in place is also appropriate in peace operations. But in other stability operations

and support operations, transition by functions may be more effective. Some of these functions include medical and engineer services, local security, communications, and logistics. Forces should not remove a capability until the replacement capability is operating.

Redeployment

2-89. How US forces terminate their involvement in stability operations and support operations may influence the perception of legitimacy of the entire operation. Planners should schedule redeployment of specific units as soon as possible after each unit has completed its part of the operations. This is critical for maintaining readiness for future operations in either the primary role of fighting the nation's wars or deploying for subsequent stability operations or support operations. Additionally, forces must properly account for funds and equipment during the transition.

2-90. Redeployment of military forces will result in a cessation or handover of operational tasks to another agency. The nature of any redeployment may vary from an emergency extraction to an administrative withdrawal or the battle handover of a peace operation mission to another force. When appropriate, redeployment will cover the transfer of operational and administrative activities to relieving troops, responsible NGOs, or civilian authorities. Units must share comprehensive after-action reviews and lessons learned as part of unit recovery operations.

Force Tailoring

2-91. In planning for stability operations and support operations, commanders must tailor a force suitable for the mission. They should plan based on each unit's ability to contribute to achieving national interests and objectives and perceptions of the indigenous population, the international community, and the American public. Commanders should also consider the synergy and enhanced capabilities inherent in joint operations when tailoring the force. Building teamwork early and continually is vital to success when forces are rapidly tailored for the mission.

Force tailoring is the process of determining the right mix and sequence of units for a mission.

FM 3-0

2-92. The force must be appropriate to the stated goals of the sponsoring authority and provide sufficient capability to deploy, complete the mission, and protect itself. The perception that employed forces exceed the limits of the mandate weakens legitimacy. Suitability varies based on the changing international perceptions, the missions to be performed, the threat, and the intensity of operations. Commanders should prepare for worst-case situations by planning to use combined arms assets.

2-93. The unique requirements of stability operations and support operations will result in the migration of CS and CSS below their doctrinally assigned levels. To maintain flexibility and agility, nondivisional CS and CSS assets can be tailored to the force in division and in some cases brigade levels. Civil affairs, military police, and PSYOP units normally assigned to a corps can be

tailored to the force to augment divisions and brigades. The inherent decentralized execution of stability operations and support operations will continue to create unique challenges when tailoring to the force.

2-94. Reserve component soldiers and units may be included in the US force under specific authority, usually under a Presidential Selected Reserve Call-up Authority. This authority carries with it unique planning requirements. FM 3-35 covers these considerations in detail.

2-95. Commanders must recognize the availability and contribution of civilians and contractors as part of the total force. Civilians may participate to provide expertise not available through uniformed service members and to most effectively use government resources. Support provided by civilians in past conflicts included, but was not limited to, communications, intelligence, contract construction, real estate leasing, water detection, civil engineering technical assistance, and logistic services. Civilians in the nonappropriated fund category staff the service exchanges and provide morale, welfare, and recreation programs. Local civilians may also be a source of both skilled and unskilled labor.

Augmentation and Liaison

2-96. The unique aspects of stability operations and support operations may require individual augmenters and augmentation cells to support personnel shortfalls and unique requirements to tailor the force. Augmentation supports coordination with the media, government agencies, NGOs, other multinational forces, and civil-military elements. METT-TC considerations drive augmentation. Augmentation requires life support, transportation, and communication. Liaison requirements are extensive in joint and multinational operations. Commanders must provide augmentees with resources and quality of life normally provided to their own soldiers.

2-97. Commanders may consider task-organizing small liaison teams to deal with situations that develop with the local population. Teams can free up maneuver elements and facilitate negotiation. Unit ministry, engineers, counterintelligence, linguists, and logistics personnel may be candidates for such teams, but combat elements may also be required. Commanders ensure that teams have transportation and communication allocated.

2-98. Commanders may form special negotiation teams that can quickly locate to diffuse or negotiate where confrontations are anticipated or occur. Teams must have linguists and personnel who have authority to negotiate on behalf of the chain of command (see Appendix E).

Special Technology

2-99. In tailoring the force, commanders must weigh the suitability of using technology based on the nature of the mandate, maintenance requirements, local sensitivities, and other factors. Technology available from battle laboratory experiments, even in small numbers, can make a big difference. Commanders of operations, however, must decide on its use consistent with mission accomplishment.

2-100. Aircraft normally used for transport may conduct air surveillance. Satellites, scout aircraft, unmanned aerial vehicles, airborne reconnaissance low, and the joint surveillance, target attack radar systems are means of aerial surveillance. Ground surveillance technology—such as radar, night vision devices, sensors, and thermal sights—may also prove useful in stability operations and support operations. All such devices may prove useful in observing and monitoring situations.

2-101. Technology with which soldiers may be less familiar includes using instruments that may assist forces in conducting operations in consonance with the principle of restraint and minimal necessary force. These types of weapons are those that could disrupt communications, radar, computers, or other communications or stop adversaries without killing or wounding them. Such technology requires special consideration of the rules of war or humanitarian practices, unintended environmental or personnel effects, availability and state of development, and postconflict activities or requirements.

2-102. Experimental electronic translation devices may be available through research and development programs, such as those sponsored by the Office of the Assistant Secretary of the Army (Research and Development).

Chapter 3

Foreign Internal Defense

Foreign internal defense (FID) is a primary program used to support friendly nations operating in or threatened with potential hostilities. FID promotes regional stability by supporting a host-nation program of internal defense and development (IDAD). These national programs free and protect a nation from lawlessness, subversion, and insurgency by emphasizing the building of viable institutions that respond to the needs of society. The most significant manifestation of these needs is likely to be economic, social, informational, or political; therefore, those needs should prescribe the principal focus of United States (US) efforts. FID can include training; material, technical, and organizational assistance; advice; infrastructure development; and tactical operations. Military assistance is often necessary to provide the secure environment for those efforts to become effective (see JP 3-07.1). Army units and individuals can be tasked to provide this military assistance.

FID is a program involving all elements of national power. Ideally, this program will incorporate all elements in a synergistic manner that best supports both host-nation requirements and US national policy and interests. The US government must integrate the efforts of multiple government agencies. The combatant commanders with geographic areas of responsibility (AORs) must plan and execute the military operations in support of FID within their regions. Army forces will participate in FID as part of a joint task force, normally to advise and assist host-nation forces conducting operations. FID is also a specified and significant mission for selected Army special operations forces (ARSOF). (See FM 3-05.)

Foreign internal defense is participation by civilian and military agencies of a government in any of the action programs taken by another government to free and protect its society from subversion, lawlessness, and insurgency.

JP 1-02

CONTENTS

Categories of FID Operations.....	3-1	Host-Nation Security Force Operations .	3-5
Indirect Support.....	3-1	The Role of the Army in	
Direct Support.....	3-2	Counterinsurgency.....	3-6
Combat Operations	3-3	Planning Considerations for FID.....	3-7
The Nature of Counterinsurgency	3-3		

CATEGORIES OF FID OPERATIONS

3-1. The military plays an important supporting role in the FID program. However, military support has a far-reaching impact on all elements of national power and cannot be conducted in isolation from other aspects of US policy in the host nation (HN). In some cases, the role of the US military may become more important because military officials have greater access to and credibility with host-nation regimes that their own military heavily influences or dominates. Military FID programs are categorized into indirect support, direct support (not involving combat operations), and combat operations. These categories represent significantly different levels of US diplomatic and military commitment and risk. However, various programs and operations within these categories can occur simultaneously.

INDIRECT SUPPORT

3-2. Indirect support emphasizes the principle of host-nation self-sufficiency. Indirect support builds strong national infrastructures through economic and military capabilities that contribute to self-sufficiency. The military contribution provides support primarily through security assistance, supplemented by joint and multinational exercises and exchange programs:

- *Security assistance (SA)* is a group of programs authorized by the Foreign Assistance Act of 1961, as amended, and the Arms Export Control Act of 1976, as amended, or other related statutes by which the United States provides defense articles, military training, and other defense-related services by grant, loan, credit, or cash sales in furtherance of national policies and objectives (JP 1-02). It mainly aims to enhance regional stability of areas of the world facing external rather than internal threats. (See Chapter 5 for a more on SA.)
- Joint and multinational exercises strengthen US and host-nation relations and the interoperability of forces. They are joint- and service-funded military exercises that demonstrate US support and commitment and that can be used to complement other FID programs, such as SA, civil-military operations (CMO), and civic assistance.
- Military exchange programs foster mutual understanding between forces, familiarizing each force with the organization, administration, and operations of the other and enhancing cultural awareness. Exchange programs, coupled with international military education and training programs are extremely valuable in improving HN and US relations. They may also have long-term implications for strengthening democratic ideals and respect for human rights among supported governments. There are three types of exchange programs:
 - Reciprocal unit exchange program. This program is for squad- to battalion-size elements. Each nation's forces trains the other's in tactics, techniques, and procedures. US commanders can use this program to sensitize their forces to the cultural and social aspects of the HN while increasing the training and readiness of host-nation forces. The proficiency of the units must be comparable to preclude exchanging fully trained US forces for untrained host-nation forces. To do so would be an extension of the SA training program and subject to the rules and restrictions of SA.

- Personnel exchange program. The personnel exchange program (PEP) is a one- to three-year program in which one person from the HN is exchanged with a US member. This program, like reciprocal unit exchanges, requires that the exchanged personnel be of comparable proficiency in their area of expertise.
- Individual exchange program. This program resembles the PEP, but it is a temporary assignment in theater. This program gives commanders flexibility, since they will not lose personnel for extended periods and can expose more soldiers to the program.

DIRECT SUPPORT

3-3. Direct support (not involving combat operations) involves US forces providing direct assistance to the host-nation civilian populace or military. It differs from SA in that it is joint- or service-funded, does not usually involve the transfer of arms and equipment, and does not usually include training local military forces. Normally, the US conducts direct support operations when the HN has not attained self-sufficiency and is faced with social threats, economic or political instability, or military threats beyond its capability to handle. Assistance will normally focus on CMO (primarily providing services to the local populace), communications, intelligence sharing, and logistic support.

Civil-Military Operations

3-4. CMO are operations and activities that embrace the relationship between military forces, civilian authorities, and the population (see definition and discussion of Civil-Military Operations in Chapter 2). Commanders can use CMO to develop favorable emotions in friendly, neutral, or hostile groups to facilitate military operations and to achieve and consolidate US objectives. CMO may be used in a preventive manner to address root causes of instability, or they may be used to support disaster relief, civil defense, counterdrug, and antiterrorism. (See Support to Counterterrorism and Support to Counterdrug Operations in Chapter 6.) CMO in FID normally include psychological operations (PSYOP), civil affairs (CA), foreign humanitarian assistance (FHA), military civic action (MCA), and humanitarian and civic assistance (HCA). More specifically—

- PSYOP ensure clear communications of US intentions and goals and take the offensive against deception initiated by adversaries. PSYOP ensure that adversaries do not misrepresent US efforts and that US forces themselves, through lack of information, do not cause the local populace to misinterpret their actions. (See JP 3-53.)
- CA facilitates the integration of US military support into the overall IDAD programs of the supported nation. (See JP 3-57 and FM 3-57.)
- FHA operations are conducted to alleviate the urgent nonmilitary needs of the host-nation populace until the appropriate civilian agencies are able to accept this responsibility. (See Chapter 6.)
- MCA is the use of predominantly indigenous military personnel to conduct construction projects, support missions, and services useful to the local population. These activities may involve US supervision and advice, but host-nation military forces will normally conduct them.

MCA is an integral part of military support to FID to assist the local government to develop capabilities to provide for the security and well being of its own population. (See FM 3-57.)

- HCA activities assist the host-nation populace with US military operations. HCA programs improve the readiness of US forces deployed in theater while residually benefiting the local populace. (See Chapter 5.)

Intelligence and Communications Sharing

3-5. US intelligence sharing ranges from strategic analysis to current intelligence summaries and situation reporting for tactical operations. An adequate intelligence collection and dissemination capability is often one of the weakest links in a host-nation military capability. US military communications hardware and operators may also be supplied when host-nation infrastructure cannot support intelligence operations.

Logistics Support

3-6. US military capabilities may be used to provide transportation or maintenance support to the host-nation military in operations that do not expose US personnel to hostile fire. The Foreign Assistance Act does not generally authorize transferring equipment and supplies. (See Appendix B.) Logistic support must be provided with consideration to the long-term effect on the capability of the host-nation or local governments to become self-sufficient.

COMBAT OPERATIONS

3-7. Introducing US combat forces into FID operations is a presidential decision. It serves only as a temporary solution until host-nation forces can stabilize the situation and provide security for the populace. US military forces in tactical operations primarily support, advise, and assist host-nation forces through logistics, intelligence, or other combat support and service support means. If US forces are committed to a combat role in FID, they will conduct offensive and defensive operations to support a host-nation fight against insurgents or terrorists.

There is another type of warfare—new in its intensity, ancient in its origin—war by guerrillas, subversives, insurgents, assassins; war by ambush instead of by combat, by infiltration instead of aggression, seeking victory by eroding and exhausting the enemy instead of engaging him...It preys on unrest...Our forces, therefore, must fulfil a broader role, as a complement to our diplomacy, as an army of our diplomacy, as a deterrent to our adversaries, and as a symbol to our allies of our determination to support them.

John F. Kennedy

THE NATURE OF COUNTERINSURGENCY

3-8. An *insurgency* is an organized movement aimed at the overthrow of a constituted government through use of subversion and armed conflict (JP 1-02). A *counterinsurgency* is those military, paramilitary, political, economic, psychological, and civic actions taken by a government to defeat insurgency (JP 1-02). Post-FID activities focus on helping a HN prevent an active

insurgency. If an insurgency already exists or a preventive measure fails, then FID focuses on eliminating, marginalizing, or reassimilating the insurgent element into society. (See Appendix D.)

3-9. *Internal defense and development* is the full range of measures taken by a nation to promote its growth and protect itself from subversion, lawlessness, and insurgency. It focuses on building viable institutions (political, economic, social, and military) that respond to the needs of society (JP 1-02). The counterinsurgency effort is the part of the IDAD strategy that addresses the insurgency threat. (See JP 3-07.1.)

3-10. Success in counterinsurgency goes to the party that achieves the greater popular support. The winner will be the party that better forms the issues, mobilizes groups and forces around them, and develops programs that solve problems of relative deprivation. This requires political, social, and economic development. Security operations by military and police forces, combined with effective and legitimate administration of justice, provide the necessary secure environment in which development can occur.

3-11. Neutralization in counterinsurgency is a political concept, not a euphemism for killing. The intent is to render elements of the insurgent organization ineffective. The first means of neutralization is political action that discredits the insurgency, its programs, and its leaders. This includes positive government programs to relieve relative deprivation and public information to counter insurgent propaganda. Arrests, trials, and convictions perceived as legitimate by the public neutralize the insurgent infrastructure. So do amnesty programs that rally insurgents to the government. An effective police, militia, and military capability neutralizes insurgent combat potential. An insurgent combat force is effectively neutralized if forced to remain inactive in remote jungles, mountains, or other difficult, sparsely inhabited areas. Security forces have no compelling reason to pursue insurgents into such areas. They can deal with them after the government controls the populated areas and then expand to the more remote regions.

3-12. The nature of the insurgency dictates the methods by which the military must oppose it. Military operations designed for war must be modified for counterinsurgency. Conventional tactics that ignore the nature of the threat will exhaust government forces and provoke the people because of harm to their lives and property. What the insurgents lose to government violence, they make up in new recruits. These recruits are disaffected by government excesses or incompetence and angered by government harm to the people. Defense against insurgency is as political as the insurgency itself. For a government conducting a counterinsurgency, military operations are strategically defensive, although they include offensive action at operational and tactical levels. Military operations must complement and reinforce political, social, and economic reform.

3-13. The following vignette details a tactic that the Viet Minh guerillas employed against the French in Vietnam in the 1950s. France deployed its forces in small, defensive strong points, trying to protect valuable facilities and friendly populations. The guerillas attacked and destroyed them one at a time. They frequently ambushed French relief columns. The French attempted to break this pattern of slow attrition by establishing a garrison at Dien

Bien Phu. The guerillas attacked and overwhelmed the French garrison in 1954, which led the French to abandon Vietnam.

The Dilemma of Concentrating Everywhere

Imagine yourself the commander of a locally recruited government rifle company charged with defending a small geographic area. Within it are 10 things that must be protected. These might be important political leaders, cultural sites, manufacturing plants, communications facilities, or anything else of political, social, or economic value.

Your rifle company consists of three platoons. Each platoon has three squads of nine soldiers each. Thus, you can assign a squad to defend 9 of the 10 things to be protected but not to all of them. Another possibility is that you can take one soldier from each squad and form a tenth squad, providing protection for each thing of value, or you could assign a half squad to all 10 and keep four squads in reserve.

The insurgents have one platoon, also locally recruited. It, too, has three squads of nine soldiers each. The defender has a 3-to-1 numerical advantage. However, the insurgents, using guerrilla tactics and attacking only when they have local superiority, attack your defended areas one at a time, using their whole platoon against each of your squads. In such circumstances, the insurgents have a 3-to-1 or better offense advantage. If the defenders have kept a reserve, the guerrillas attack and withdraw before it can react. If terrain is favorable, the insurgents lay an ambush for the reaction force, using the advantage of defense in prepared positions.

If the government force takes the offensive and pursues the guerrillas, the guerrillas refuse to give battle. They simply move out of the government's way until the force completes its sweep. In the process, they may also attack one or more of the defended areas while the government forces are occupied in a futile offensive operation.

HOST-NATION SECURITY FORCE OPERATIONS

3-14. The security forces in counterinsurgency consist of the civil police, the paramilitary (also called the militia), and the military. The elements of the security force work in concert to—

- Protect or isolate the population from the insurgents.
- Neutralize or defeat the guerrilla forces.

3-15. The first line of defense for the government is its police forces, which may be organized either nationally or locally. In either case, their actions must be well coordinated into the total IDAD program. The first objective of the police is to destroy the illegal infrastructure of the insurgent organization. Police intelligence must identify and locate leaders, penetration agents, intelligence and PSYOP agents, terrorists, and recruiters. The police arrest them using the minimum violence necessary. These arrests should be based on probable cause and executed on the warrant of a disinterested magistrate. To maintain government legitimacy, the police must follow due process of law. Corruption and abuse of human rights by security forces and the

judiciary can contribute significantly to societal turmoil. The legislature should enact emergency powers when required. These powers must provide for a regular process that the people know well and protect the rights of the innocent. Emergency powers should apply only in threatened combat zones and be rescinded as soon as the situation permits.

3-16. Militia forces are organized to provide for popular self-defense. Militia forces serve in their home areas. They may be either full- or part-time forces, depending on the situation. They combine light infantry capabilities with police techniques. These forces aid the police in law enforcement, to include searching the insurgent infrastructure. They also provide a local defense against attack by insurgent combat forces. Together with the police, they protect or separate the insurgents from the people, preventing the insurgents from mobilizing forces and resources.

3-17. The regular armed forces are the shield behind which political, social, and economic development occurs. Their primary mission is to protect the government, police, militia, and development organizations from insurgent guerrilla forces. Emphasis on the defensive nature of counterinsurgency helps prevent government harm of the people. Collateral damage destroys government legitimacy. The insurgents' best recruiting program is indiscriminate killing and damage by government forces. Keeping violence to the absolute minimum is important to the government.

3-18. Counterinsurgency is difficult, frustrating, and dangerous. Occasionally government forces may behave incorrectly out of anger, from frustration, or for some other reason. When members of the security forces engage in criminal acts of any kind, punishment must be fair, quick, certain, and public. No perception of special treatment for security forces must be permitted. Security forces must not be permitted to harm the people with impunity.

3-19. A major function of the security forces is intelligence. All operations should be based on solid intelligence. It identifies insurgent personnel, activities, and organizations, enabling the government to neutralize offenders without harming the innocent. Infantry forces must expand on the intelligence provided by technical units to achieve contact with the enemy. Generally, government forces should only conduct offensive operations based on good intelligence.

3-20. The capabilities of the security forces are also employed in the development side of the IDAD strategy. The armed forces are a valuable national resource for development. The military capabilities of leadership, organization, technical skills, discipline, equipment, mobility, and communications can all be employed in the development effort. Their use is limited only by the imagination of government planners and law. Armies and other security forces can more capably work under hazardous and austere circumstances than civilian organizations.

THE ROLE OF THE ARMY IN COUNTERINSURGENCY

3-21. The role of the Army in counterinsurgency centers on administering and executing SA programs. Each geographical commander of a combatant command advises the Department of State in developing SA packages appropriate for the situation. Each combatant command provides military supplies

and services under the program as well as military advice, tactical and technical training, and intelligence and logistic support. (See Chapter 5.) Army forces help the host government police, paramilitary, and military forces perform counterinsurgency, area security, or local security operations. They advise and assist in finding, dispersing, capturing, and destroying the insurgent force. Army forces emphasize the training of national, state, and local forces to perform essential defense functions. They aim to provide a secure environment in which developmental programs can take effect while respecting the rights and dignity of the people.

3-22. US policymakers determine the scope of military participation based on US interests and the desires of the HN. The US military aims to improve the effectiveness of the supported security forces and to help stop external support to the insurgents.

3-23. Generally, US forces do not engage in combat. The threat to American interests does not support that degree of involvement, even if it were effective. An American combat role tends to undermine the legitimacy of the host government and risks converting the conflict into an American war. However, on the rare occasion when the threat to US interests is great and indirect means have proven insufficient, US combat operations may be required. Direct use of US combat forces in counterinsurgency remains a policy option for the president, and Army forces must provide it when required.

3-24. Host-nation forces should conduct security and stabilization programs when necessary, employing, for example, populace and resource control. The HN should provide representatives to assist US forces in their contacts with local populations.

3-25. US forces may conduct strike operations to disrupt and destroy insurgent combat formations. These operations prevent the insurgents from attacking government-controlled areas. They also disrupt insurgent efforts to consolidate and expand areas already under their control. US combat forces may conduct security and defensive operations in support of host-nation consolidation operations or to assist the HN to expand its mobilization base. Success in consolidation operations enables the HN to resume the military aspects of its counterinsurgency campaign and allows US combat forces to withdraw.

PLANNING CONSIDERATIONS FOR FID

3-26. Planners must consider the long-term or strategic effects of all US assistance efforts before implementing FID programs. This long-term consideration is especially important in building host-nation development and defense self-sufficiency. Both may require large investments of time and materiel.

3-27. Planners must tailor military support of FID programs to the environment and to the specific needs of the supported HN. They must consider the threat as well as local religious, social, economic, and political factors when developing the military plans to support FID. Overcoming the tendency to use a US frame of reference is important. This potentially damaging

tendency can result in unsuitable equipment, training, and infrastructure for the nation receiving US assistance.

3-28. Planners must understand that a basic premise of the FID program is that the ultimate responsibility for IDAD rests with the HN. US planners must measure all FID plans against this precept.

3-29. The legal restrictions governing military activities in support of FID are complex and subject to changing US legislation. (See Appendix B.) The staff legal advisor has an active role in the FID planning process. The basic funding authorizations for military activities in support of FID come through the Foreign Assistance Act, Arms Export Control Act, or Department of Defense operations and maintenance funding sources. Appendix A of JP 3-07.1 details the legal aspects of FID and provides rulings on several FID programs that may assist commanders in establishing a legal yardstick for FID plans.

3-30. US combat operations judiciously select and employ forces. Such selection and employment ensures that the host-nation military rapidly accepts the responsibility for the security of the nation and ensures minimal civilian casualties. Specific rules of engagement will likely be more restrictive in FID than in offensive and defensive operations. However, the existence of such restrictive rules of engagement does not preclude the US from employing that level of force which the president determines necessary to stabilize a friendly host government or to protect the lives of deployed US personnel.

Chapter 4

Peace Operations

Properly constituted, peace operations can be a useful tool to advance American national interests and pursue our national security objectives.

PDD 25

With the Cold War's end, the threat of global war has become distant. New opportunities have emerged to promote peace, prosperity, and enhanced cooperation among nations. The Cold War's end has also brought increasing regional instability. Although the causes are much debated, many world situations continue to be complex, dynamic, and dangerous. Uncertainty exists in how the security environment will evolve. Challenges to global and regional stability fall into the following categories: cross-border aggression, internal conflict, transnational threats, development and proliferation of dangerous military technologies, and humanitarian disasters. These challenges have compelled the international community to increasingly call on military forces to prevent or end conflicts. Operations such as those occurring in Somalia (1992-1993) and Bosnia (1992-1995) made obvious the need for clear guidance in United States

CONTENTS

Forms of Peace Operations	4-2	Civil-Military Operations	4-17
Peacekeeping	4-3	Legitimacy	4-19
Observation Missions	4-3	Perseverance	4-19
Supervision and Assistance	4-4	Command and Control	4-19
Peace Enforcement Operations	4-6	Command Relationships	4-20
Peace Enforcement Overview	4-6	Coordination	4-20
Peace Enforcement Subordinate		Intelligence	4-21
Operations	4-7	Principles of Intelligence and	
Operations in Support of Diplomatic		Electronic Warfare Support	4-21
Efforts	4-11	Intelligence Functions	4-22
Support to Preventive Diplomacy	4-11	Information Operations	4-24
Support to Peacemaking	4-11	Nature of Information Operations	4-24
Support to Peace Building	4-11	Fundamentals of Information	
Concept of Employment	4-12	Operations in Peace Operations	4-24
Fundamentals of Peace Operations	4-13	Civil Law and Order	4-26
Consent	4-14	Police	4-26
Impartiality	4-15	Judiciary	4-26
Transparency	4-15	Penal	4-27
Restraint	4-16	War Crimes and Criminals	4-27
Credibility	4-17	Logistics	4-27
Freedom of Movement	4-17	Force Protection	4-28
Flexibility	4-17		

(US) participation for peace operations (PO). In response, the president issued Presidential Decision Directive (PDD) 25. Joint doctrine for PO is in JP 3-07.3.

As in all operations, the military remains subordinate to civilian authority. Whether the mission is to conduct peacekeeping operations (PKO), conduct peace enforcement operations (PEO), or support diplomatic efforts, PO are a continuation of the political process. Synchronizing all instruments of national power leads to successful PO. This is best done through strong interagency leadership and an integrated political-military (Pol-Mil) plan. In May 1997, the president signed PDD 56. This policy requires US government agencies to institutionalize the lessons learned from recent experiences and outlines a process that establishes procedures for an interagency body to produce an integrated plan to provide strategic clarity.

FORMS OF PEACE OPERATIONS

4-1. PO are multiagency operations involving diplomatic and humanitarian agencies with military support. They may be conducted to prevent or control a conflict, in support of a peace settlement, or in response to a complex emergency.

4-2. Peace operations will be conducted on the basis of appropriate legal authority, the precise nature of which will often depend on the circumstances. For example, the United Nations (UN) Security Council or some other competent body

may issue a formal mandate for the operation. The mandate establishes both the political and military objectives as well as its scope of authority. In some cases, guidance is detailed; in others it may be vague. The end state is a peaceful settlement among all parties. The military commander through the military decision making process determines appropriate military objectives and end states.

The broad term *peace operations* encompasses peacekeeping operations and peace enforcement operations conducted in support of diplomatic efforts to establish and maintain peace.

JP 3-07

4-3. The Army will participate in PO, either as part of a UN, North Atlantic Treaty Organization (NATO), multinational force, or unilaterally. However, unilateral employment is the least prevalent option. The US usually prefers the enhanced legitimacy of a multinational force. Additionally, Army forces will operate with international organizations, nongovernmental organizations (NGOs), and other agencies participating in the peace process. The success of the overall peace operation depends in part on the degree of cooperation among these various actors. In PO, there is neither an enemy nor a military victory. The forms of PO are peacekeeping operations, peace enforcement operations, and operations in support of diplomatic efforts. (NATO refers to PKO and PEO as “peace support operations.”)

PEACEKEEPING OPERATIONS

4-4. *Peacekeeping* consists of military operations undertaken with the consent of all major parties to a dispute, designed to monitor and facilitate implementation of an agreement (ceasefire, truce, or other such agreement) and support diplomatic efforts to reach a long-term political settlement (JP 3-07). Before PKO begin, a credible truce or cease-fire is in effect, and the parties to the dispute must consent to the operation. Peacekeeping takes place following diplomatic negotiation and agreement among the parties to a dispute, the sponsoring organization, and the potential troop-contributing nations.

4-5. The UN Charter makes no specific mention of PKO. These operations have evolved as a pragmatic response to various conflicts with which the UN has dealt. Peacekeeping seeks to settle disputes through the medium of peaceful third-party initiatives. It has often proven valuable in peace accords and agreements following interstate conflict. PKO have usually been conducted in accordance with Chapter VI of the UN Charter.

4-6. The peacekeeping force must use all techniques available, short of coercive force, to gain and maintain the initiative. Using force in a peacekeeping mission is generally limited to self-defense. The force maintains and promotes consent so the political process can continue to guide the parties to a lasting settlement. A loss of consent by the parties usually necessitates the withdrawal of the peacekeeping force or a change in its mission to one of peace enforcement.

OBSERVATION MISSIONS

4-7. United Nations observation missions are performed primarily by unarmed military observers (MILOBs) but may also be performed by peacekeeping (PK) forces. In either case, observer forces help ensure that the parties to the dispute follow the agreements. UN observer groups may also use civilian personnel or police as observers. Regional organizations, such as the Organization for Security and Cooperation in Europe, also conduct observation missions. The multinational force and observers and Military Observation Mission Ecuador-Peru are examples of ad hoc observation missions. The success of these missions depends on the willingness of the disputing parties to cooperate with the terms of the accord or agreement. This willingness may exist because MILOBs have established a visible presence and are able to detect agreement violations. They have four tasks:

- ***Observing, monitoring, verifying, and reporting any alleged violation of the governing agreements.*** Agreements may include treaties, truces, cease-fires, arms control agreements, or any other binding agreements between the disputing parties. The primary means for observing and monitoring include observation posts (OPs), mounted and dismounted patrols, and aerial reconnaissance. OPs should provide prolonged and unobstructed observation of people or areas as specified by the mission. OPs can be temporary, occupied periodically for a matter of hours or days, or more permanent. Permanent OPs may require extensive engineer support for force protection, sustainment, and use as a support base from which to mount patrols. Patrols are used to confirm or supervise a cease-fire by establishing a presence to

grant legitimacy to both the PK force and the cease-fire accords or agreement. Patrols also provide surveillance within a buffer zone (BZ) to report violations of the agreement. Violations may include incidents such as offensive combat operations, unauthorized troop movements, reinforced defensive positions, or even provocative radio broadcasts. Aerial reconnaissance conducted by rotary-winged aircraft permits the commander to quickly survey a large area. On-board cameras can provide near-real time feedback to the commander. Terms of reference (TOR) may restrict the types of weapon systems available to the PK force. Maintaining up-to-date information on the disposition of disputing forces in the operational area is critical to PKO. This will require periodic visits to forward positions to observe and report on the disposition of forces of the disputing parties.

- ***Investigating alleged cease-fire violations, boundary incidents, and complaints.*** The observer force investigates alleged infractions to gain evidence regarding agreement violations. It may become involved in negotiation or mediation, to include direct dialogue, between the disputing parties. The two parties should conduct negotiation or mediation on neutral territory. The unit commander, if at all possible, remains separate from the process to serve as the “honest broker” and to maintain a sense of impartiality. The commander is provided or selects a mediator whom all parties perceive as fair and impartial. Some NGOs, such as the International Committee of the Red Cross (ICRC), can provide mediation services. Reconciling differences at the lowest possible level often contributes to the overall success of PKO.
- ***Conducting regular liaison visits within the operational area.*** Disputes thrive on rumors, uncertainty, and prejudice. Therefore, liaison visits maintain personal contact. They permit a timely and routine exchange of information with disputing parties, the host nation, local civilian officials, international agencies, PK force headquarters, and other national contingents.
- ***Verifying the storage or destruction of certain categories of military equipment specified in the relevant agreements.*** If the terms of the relevant agreement require belligerents to establish weapon storage sites for certain categories of weapons, the PK forces must periodically inspect these sites to ensure compliance. The inspection team will inventory supplies, weapons, and equipment at each site and report discrepancies. PK forces must plan for uncooperative local officials, demonstrations, and other forms of civil disturbance. As observer and inspection teams are unarmed, the team will withdraw if unable to negotiate entrance to the site.

SUPERVISION AND ASSISTANCE

4-8. Lightly armed forces normally perform supervision and assistance missions. The force undertaking these tasks requires large service support organizations, equipment, and finances. In addition to those tasks being performed by MILOBs in observation missions, PK forces may perform other tasks when they are within the scope of the military mission, support the desired end state, and are authorized by appropriate authority. These tasks include—

- ***Supervising cease-fires.*** Once a cease-fire is arranged, forces may observe and report on the disputing parties' compliance with a cease-fire. The force may have to deploy on the territory of more than one nation to perform its mission. The tempo and outcome of diplomatic activities taken to establish a credible cease-fire are often unpredictable, and negotiations to constitute and insert a force may occur simultaneously. Therefore, the PK force may need to deploy rapidly. As heavy weapons—such as tanks, fighting vehicles, and artillery—may be inappropriate or prohibited, units may require additional vehicles and helicopters to provide tactical mobility.
- ***Supervising disengagements and withdrawals.*** As diplomatic activity continues, agreement to establish a BZ may require PK forces to supervise the disengagement and withdrawal of hostile forces. The PK force positions itself between the disputing parties to prevent a breakdown of the cease-fire and help ensure an uneventful disengagement and withdrawal. Timely deployment and implementation of well-conceived and detailed plans that are understood by all parties greatly reduces the inherent risks associated with interpositioning. The PK force personnel may mediate disagreements in the positioning of the disputed parties' forces, verify troop and equipment dispositions, and, if authorized, provide assistance to the civilian population in the BZ.
- ***Supervising prisoner of war exchanges.*** At any stage in resolving a dispute, PK forces may be asked to supervise and assist in prisoner of war exchanges between the parties. TOR, status-of-forces agreements (SOFAs), rules of engagement (ROE), or the mandate of the force may provide guidance on missions that PK forces are authorized to conduct. PK units will be required to monitor the exchange site and may be asked to provide logistic support, such as transportation for prisoners of war and medical treatment and evacuation. The designated mediator, such as the ICRC or UN, will execute the actual exchange.
- ***Assisting civil authorities.*** PK forces may assist civil authorities in functions such as observing procedures at polling sites, transferring authority, partitioning territory, evacuating, escorting convoys, or temporarily administering civil functions. The civil-military operations (CMO) staff officer, coordinating with the civil-military operations center (CMOC), provides advice and assistance to execute these functions.
- ***Providing military support to elections.*** PK forces may be asked to support elections. Military forces may be required to assist civil authorities in providing a secure environment so elections can proceed. Such assistance may be as simple as providing administrative support and security of polling stations to creating an environment conducive for displaced persons to return to their rightful voting place. The military's primary responsibility is to prevent a disrupted election process. The integrity of the elections themselves is the responsibility of the election commissions. Many tasks—such as freedom of movement, security patrols, OPs, and medical support—are ancillary to ongoing PKO. Commanders must incorporate the appropriate agencies—International Police Training Force, UN Office of the High Commissioner for Refugees, mayors, local police, former warring factions—emphasizing each agency's responsibilities for maintaining law and order during the

election. Commanders can offer the use of psychological operations (PSYOP) assets (audio, visual, and audiovisual) to more effectively disseminate information regarding the elections (such as registration procedures, polling places, security measures, and election results).

- ***Assisting in the maintenance of public order.*** PK forces may assist in reestablishing or maintaining public order. The responsibility for public order rests with the civil police. However, military assistance may be required if a breakdown has occurred in the civil police structure or if situations are beyond the civil police capacity to control.
- ***Assisting in foreign humanitarian assistance operations.*** Although foreign humanitarian assistance (FHA) is not a peace operation, it may be necessary for PK forces to provide security and logistic support for relief operations within a complex contingency. It may also be necessary for PK forces to provide transportation and security for NGOs and other agencies. Civil affairs (CA) personnel provide to the commander a resource for the planning and conduct of FHA. See Chapter 6 for discussion of FHA.

PEACE ENFORCEMENT OPERATIONS

4-9. *Peace enforcement* (PE) is the application of military force, or the threat of its use, normally pursuant to international authorization, to compel compliance with resolutions or sanctions designed to maintain or restore peace and order (JP 3-07). PE operations are by definition coercive in nature and rely on the threat or use of force. However, the impartiality with which the peace force treats all parties and the nature of its objectives separates PE from war. Should it be necessary to conduct operations in support of one particular party against another, then the PE would deteriorate into war. If this situation develops, then the authorizing authority must reassess the operation. The purpose of peace enforcement is not to destroy or defeat an enemy, but to use force or threat of force to *establish a safe and secure environment* so that peace building can succeed.

4-10. The term peace enforcement is not specifically mentioned in the UN Charter; however, the charter's language allows the Security Council to authorize military operations. Specifically, Chapter VII empowers the council to take such actions "as may be necessary to restore or maintain international peace and security" (Article 42 of the UN Charter). It is accepted that the UN is not now in a position to adequately conduct peace enforcement operations on its own, but rather only peacekeeping operations. Peace enforcement operations are often conducted by regional organizations or a coalition of states.

PEACE ENFORCEMENT OVERVIEW

4-11. Since PE may include offensive and defensive operations, missions must be clear and end states defined. Transition to combat action requires successfully applying warfighting skills. In a theater of operations, offensive, defensive, stability, and support operations will occur simultaneously. Forces conducting PE may be involved in forcibly separating belligerent parties in one location and assisting with refugees just a few kilometers away.

4-12. The forces employed for such operations will be armed and equipped based on commanders' visualizations and the factors of METT-TC—mission, enemy, terrain and weather, troops and support available, time available, civil considerations. Combat arms units, with combat support and combat service support units are most often employed in this role. Special operations forces, especially CA and PSYOP assets, directly assist in developing consensus and sustaining legitimacy that contributes to peace and security.

4-13. PE operations are normally conducted in several phases. The first phase involves inserting rapidly deployable combat forces to establish a significant and visible military presence. Subsequent phases involve stabilizing the area and transitioning from a military presence to support for the development of a competent civil authority. Any number of subordinate operations may be conducted simultaneously or sequentially.

PEACE ENFORCEMENT SUBORDINATE OPERATIONS

Forcible Separation of Belligerents

4-14. This operation poses the highest risk of any PEO. Forcible separation may involve reducing the combat capability of one or more of the belligerent parties by disarming and demobilizing them. The PE force normally retains the right of first use of force. Forces conducting forcible separation require extensive offensive combat capability, as well as combat

support and combat service support. The goal is to force the belligerent parties to disengage, withdraw, and subsequently establish a BZ or demilitarized zone (DMZ). Security operations—such as screening, combat and reconnaissance patrolling, performing cordon and search, and establishing checkpoints and roadblocks to control movement into and within the BZ or DMZ—may be conducted to maintain the separation of belligerent parties.

4-15. **Separate Belligerents.** PE force commanders must negotiate with commanders of both sides, at the tactical level, to achieve and verify agreement on withdrawal procedures. Belligerents should be required to withdraw to positions that allow no observation and direct fires into the area. The commander must understand the strength of the belligerent forces both in the proposed area of separation (AOS) and those forces outside the area with the capability to reinforce. The PE force must be prepared to conduct combat operations, to seize key terrain and otherwise force the withdrawal of reluctant belligerents, and to secure the AOS. The PE force should pre-position itself *quickly* to fill the void created by the retreating belligerents. If possible, the PE force should place liaison officers, with appropriate transportation and communications, with the headquarters of the opposing sides. Once the area of separation is established, PE forces secure the area with a highly visible presence by patrols, checkpoints, and OPs. PE forces must be

PE Subordinate Operations

- Forcible separation of belligerents
- Establishment and supervision of protected areas
- Sanction and exclusion zone enforcement
- Movement denial and guarantee
- Restoration and maintenance of order
- Protection of humanitarian assistance

FM 3-0

prepared to conduct defensive combat operations to repel attack and offensive combat operations to restore the area of separation. The AOS is three-dimensional and may require air defense weapons and detection systems to control no-fly zones.

4-16. **Disarm Belligerents.** The mandate may require the PE force to disarm or demobilize the belligerent parties. These tasks are complex, difficult, and often dangerous. The PE force demonstrates a clear resolve and intent to disarm or demobilize designated belligerent parties according to the agreement. If these actions are taken prematurely without adequately preparing and involving the parties, the situation may destabilize, leading to a reemergence of violence. If the PE force has responsibility to store, secure, and account for collected weapons, it must establish a storage area large enough for inspecting, storing, and if directed, destroying weapons and materiel. Space must be allocated to support a security force and support administrative requirements, such as accounting for materiel stored, collected, transferred, or destroyed. The PE force must maintain logs accounting for personnel or units surrendering materiel. Security and accountability is critical.

4-17. Disarming may include seizing ammunition, collecting and destroying weapons and supplies, closing weapons and ammunition factories, and preventing resupply. Humanitarian demining operations (HDO) are a part of the disarmament program. Because of the threat to peace and safety posed by landmines, HDO have become a significant PO activity. Many countries already have pre-existing mine clearance activities conducted by the UN or NGOs. In many demining missions, military ordnance specialists from the US or other countries partner with civilian organizations such as the United Nations Mine Action Service. Demining is ultimately a host-nation responsibility. Army participation in HDO focuses on mine awareness education and, most importantly, training of host-nation personnel in the surveying, marking, and clearing of mines. Army personnel do not remove mines; however, they assist and train others in demining techniques and procedures. Specialists, such as explosive ordnance disposal personnel, may be called on to destroy unexploded explosive ordnance, such as munitions shells, fuses, grenades, and rockets. Special forces, CA, and PSYOP personnel are currently the primary means to execute the geographic combatant commanders' HDO programs. Explosive ordnance disposal and engineer personnel are also included in these programs and integrated into operational training missions.

4-18. **Demobilization.** Demobilization is the process of transitioning a conflict or wartime military establishment and defense-based civilian economy into a peacetime configuration while maintaining national security and economic vitality. Following demobilization, Army forces may support integrating military and paramilitary forces into society by providing training, advice, and assistance for the new defense or security force, and through information operations. Army forces have a role in demobilization that may include—

- Providing intelligence support and overall security during the demobilization process.
- Providing incentives and disincentives for the forming, arming, and training of the new defense force.
- Supporting with information operations.

- Supporting these actions through the joint commissions.
- Providing liaison coordination teams to local commanders as a confidence-building measure during the disarmament and demobilization.

Establishment and Supervision of Protected Areas

4-19. The requirement to establish and supervise a protected or safe area can arise when any community is at risk from persistent attack. Unless those in the safe area are disarmed, it may be used as a base from which to conduct raids and attacks. Commanders must be clear on what is expected of the force tasked to establish and maintain a protected or safe area. Inevitably, commanders will need to counter accusations from those within and beyond the protected area that the operation is designed to assist the other side. The nature of the threat will determine the force profile required to secure the protected area.

4-20. Protected areas may contain residents, refugees, displaced persons, and substantial numbers of forces of one or more of the belligerent forces. Army forces may be charged to establish and supervise such areas, as well as to provide support and assistance to other organizations in the protected area. The first requirement to making the area safe is to demilitarize the area. Once accomplished, additional tasks may include—

- Establishing, monitoring, and enforcing weapon exclusion zones.
- Establishing and maintaining cantonment areas and weapon-holding areas and sites.
- Conducting patrols and searches.
- Manning checkpoints and other control measures.
- Planning for reinforcement and extraction.

Sanction and Exclusion Zone Enforcement

4-21. Enforcement of sanctions includes a broad range of possible missions. Commanders must understand that actions to enforce sanctions, while endorsed by the UN Security Council, have traditionally been considered acts of war and should posture their forces accordingly.

4-22. Restricting the flow of goods across international borders is accomplished by using OPs, dismounted and vehicular patrols, and aerial surveillance integrated with checkpoints. Unauthorized or contraband supplies and equipment are confiscated or destroyed. Units must be prepared to stop individuals involved in illegal activity and turn them over to the civil authority.

Movement Denial and Guarantee

4-23. While similar to the PK mission of observing forces, in PE forces may be authorized to use force to prevent unauthorized movement of military forces versus merely to observe and report such activity. PE forces must have sufficient firepower to compel the belligerent forces to honor the agreement.

4-24. PE forces guarantee transit rights of noncombatants, NGOs, or other designated groups through their controlling presence and deterrence. PE

forces may have to physically occupy certain terrain and structures, such as road intersections and bridges, to protect unobstructed freedom of movement. PE forces must have sufficient strength to deal with a wide range of challenges, from civil disturbances to attacks by belligerent forces.

Restoration and Maintenance of Order

4-25. Operations to restore order are conducted to halt violence and to support, reinstate, or establish civil authorities. In a failed state situation, international law may require the commander to establish law and order in his geographic area of operations and to provide a minimum standard of humane care and treatment for all civilians. These operations are designed to restore stability to the point where indigenous police forces can effectively enforce the law and reinstate civil authority. PE forces may be required to conduct combat operations, confiscate weapons, and suppress or detain threatening elements. They may provide security and assist in training a new police force before transferring the responsibility for long-term security to the UN.

4-26. When assisting in establishing law and order, PE forces may support local or international police forces or—in the absence of any civil authority—execute alone. PE forces may be given the authority to detain persons suspected of criminal or unlawful actions. Detainees may possess weapons or other forms of contraband. TOR, SOFA, and ROE define those activities that PE forces are obligated to prevent. Interpreters and military police officers should be used when possible. Detainees should be quickly processed on-site and evacuated to a holding area. Procedures for search, interrogation, segregation, and security are strictly enforced. PE forces are responsible for the humane treatment and facilities accorded the detainees.

4-27. PE forces may be required to search a particular site or a general area (rural and urban) to apprehend personnel, confiscate contraband, interdict smuggling operations, or to sustain a secure environment. Operations may be as simple as using checkpoints to search personnel and vehicles or as complex as a cordon and search operation. PE forces may have to temporarily restrict civilian freedom of movement, using curfews or restricted routes and areas. Searches, apprehensions, and seizures must be legal and in strict compliance with the mandate or agreement.

Protection of Humanitarian Assistance

4-28. PE forces may be tasked to provide protection for humanitarian assistance. This mission might include protection for NGOs, US government agencies, and other military personnel who provide humanitarian assistance. Such protection may include securing base areas, such as air and sea ports, protecting routes or corridors for transporting relief supplies, escorting convoys, and providing security for distribution sites. If belligerent parties oppose the delivery of relief supplies by NGOs or other agencies, then PE forces may deliver the supplies by providing airlift or other forms of logistic support to FHA operations.

OPERATIONS IN SUPPORT OF DIPLOMATIC EFFORTS

4-29. Military support of diplomatic efforts improves the chances for success in the peace process by lending credibility to diplomatic actions and demonstrating resolve to achieve viable political settlements. In addition to or as an integral part of PO, Army forces may conduct operations in support of diplomatic efforts to establish order before, during, and after conflict. While these activities are primarily the responsibility of civilian agencies, the military can support these efforts within its capabilities. Army forces may support diplomatic initiatives such as preventative diplomacy, peacemaking, and peace building.

SUPPORT TO PREVENTIVE DIPLOMACY

4-30. *Preventive diplomacy* consists of diplomatic actions taken in advance of a predictable crisis to prevent or limit violence (JP 3-07). Army support to preventive diplomacy may include shows of force (see Chapter 5) such as preventive deployments or increasing levels of readiness. A *preventive deployment* is the deployment of military forces to deter violence at the interface or zone of potential conflict where tension is rising among parties. Forces may be employed in such a way that they are indistinguishable from a peacekeeping force in terms of equipment, force posture, and activities (JP 1-02). The objective is to demonstrate commitment to a peaceful resolution while underlining willingness to use a ready and capable military force if necessary. When confronted with the military resolve of the international community, the competing factions or governments will reluctantly engage in violent conflict. Should deterrence fail, the preventive deployment force must be robust enough to defend itself while a decision is made either to withdraw or reinforce.

SUPPORT TO PEACEMAKING

4-31. *Peacemaking* is the process of diplomacy, mediation, negotiation, or other forms of peaceful settlement that arranges an end to a dispute and resolves the issues that led to it (JP 3-07). Diplomatic efforts are essential to create the conditions for a signed agreement. Military leaders should be involved in negotiating the military aspects of a peace agreement. This often includes face-to-face meetings with the military leaders of the warring factions. Army support to peacemaking includes military-to-military relations, security assistance (see Chapter 5), peacetime deployments, or other activities that influence the disputing parties to seek a diplomatic settlement.

SUPPORT TO PEACE BUILDING

4-32. *Peace building* consists of post-conflict actions, predominantly diplomatic and economic, that strengthen and rebuild governmental infrastructure and institutions in order to avoid a relapse into conflict (JP 3-07). It provides the reconstruction and social rehabilitation that offers hope to resolve the conflict and sustain the peace. Military forces have a limited yet essential role in supporting peace building. Peace building begins while PEO or PKO are underway and may continue for years.

4-33. Army support to peace building can include the same activities as longer-term foreign internal defense operations (see Chapter 3). Support to

peace building may also include military support to relief, rehabilitation, reconstruction or development, negotiation and mediation, management of arms, or assisting in human rights investigations by other agencies. In some cases, Army forces may directly provide support to a recovering host nation or population. Specific types of support may include, but are not limited to, demobilization of belligerent parties, training for demining, temporary support to or repatriation for refugees, return of displaced persons to their original homes, electoral assistance, maintaining public order and security, and maintaining a deterrent presence. JP 3-57 and FM 3-57 provide details on CMO activities that Army forces may conduct in support of peace building.

CONCEPT OF EMPLOYMENT

4-34. *Complex contingency operations* are large-scale peace operations (or elements thereof) conducted by a combination of military forces and nonmilitary organizations that combine one or more of the elements of peace operations which include one or more elements of other types of operations such as foreign humanitarian assistance, nation assistance, support to insurgency, or support to counterinsurgency (JP 3-57). These operations do not spring up overnight. In the case of a humanitarian crisis, various organizations, including governmental and nongovernmental organizations, will identify the early symptoms and attempt resolution, usually before the situation attracts the attention of the international media. A wider international response may be demanded should the situation degenerate and an armed conflict causes destabilization, starvation, or human rights violations beyond the immediate capacity of diplomatic teams, UN agencies, and NGOs to resolve. These organizations provide the international community with the first evaluation of the crisis.

4-35. As the situation degenerates, the media will focus on the issue. National and international news media coverage plays a major role in quickly framing public debate and shaping public opinion. The news media serves as a forum for the analysis and critique of goals, objectives, and actions. It can influence political, strategic, and operational planning, decisions, and mission success and failure. It will be a major factor in shaping the international community's response.

4-36. Numerous actions on the diplomatic front will be mounted. The military may support diplomatic efforts by conducting demonstrations, exercises, or preventive deployments. If consensus can be reached between states or among the parties to a dispute and a peace agreement is signed, then the UN Security Council may authorize a peacekeeping operation in accordance with Chapter VI of the UN Charter. If consensus is not reached or if the consensus of all the participants is not clear even with a signed document, then the UN Security Council may authorize a PE mission in accordance with Chapter VII of the UN Charter.

4-37. The military objective in all these operations is to create the conditions for other political, economic, and humanitarian peace building activities to achieve the political objective stated in the mandate and to transition from involvement. Building consensus among the parties to the conflict is critical and allows the force to lower its operational profile to one more akin to PKO.

As the situation allows, PK techniques should be gradually introduced and the operation should come increasingly to resemble a PK mission.

4-38. The situation is considerably different and more challenging if a PK operation must be reconfigured as a PE operation. If consent is lost, a PK force is not capable of dealing with the situation (see Figure 4-1). New political decisions, mandates, ROE, or force compositions will be necessary. Optimally, Army forces should not transition from one peace operation role to another unless a mandate or a political decision changes and appropriate adjustments to force structure, ROE, and other aspects of the mission are made. The PK force may have to be replaced rather than augmented. These changes will take time during which the PK force may be placed in a precarious position of having neither the authority nor the capability to accomplish its tasks. It is essential that the political and military decision makers clearly understand the local situation before issuing a mandate. PK forces should not be deployed when consensus is lacking.

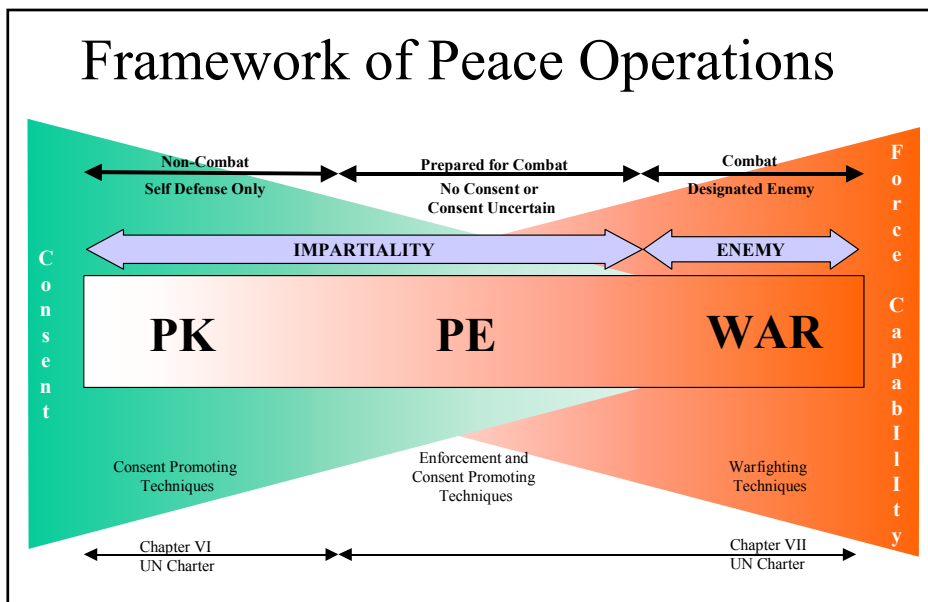

Figure 4-1. Framework of Peace Operations

4-39. In the event of a collapsed or failing state, peace building is essential to strengthen and rebuild government infrastructures and institutions. Peace building creates a self-sustaining peace and avoids a relapse into conflict. Peace operations are designed to establish a stable environment in which peace building can occur. Without the active support and participation of the parties in conflict as well as the host nation as a whole, no peace operation will succeed.

FUNDAMENTALS OF PEACE OPERATIONS

4-40. The foundations of stability operations and support operations discussed in Chapter 1 apply to peace operations. The following fundamentals also apply specifically to peace operations. Commanders and participants

should understand these concepts as they conduct peace operations: consent, impartiality, transparency, restraint, credibility, freedom of movement, flexibility, civil-military operations, legitimacy, and perseverance.

CONSENT

4-41. In war, consent is not an issue for the military commander. In peace operations, however, the level of consent determines fundamentals of the operation. One side may consent in whole or in part, multiple parties may consent, there may be no consent, or the consent may vary dramatically over time. There may be consent at the strategic level among the party representatives signing an agreement. However, renegade local groups at the tactical level may disagree with their leaders and remain hostile to a peace operation. By its nature, a PE force must be employed in operations even when there is no general consent or when there is uncertainty regarding consent. Figure 4-1 shows the relationship between the amount or level of consent and force capability requirements. When strong consent or commitment by the parties to the peace agreement exists, then reduced force capability is required. Peacekeeping operations are appropriate under these conditions. But as the level of consent decreases, the level of force capability to enforce compliance must increase, creating conditions for peace enforcement operations.

4-42. The promotion of consent is fundamental to achieving the political end state in all peace operations. Closely linked to consent is the compliance with the agreement or mandate. The enforcement of compliance may be a necessary condition to maintain consent.

4-43. Peace without justice may undermine consent and eventually the entire peace operation. Civil strife may have destroyed or compromised the police and judicial system beyond repair, forcing the PE force to assume those functions until a civil system is in place, often under the supervision of international civilian police. The commander must participate in the interagency process to determine the tasks and responsibilities in relation to the *rule of law* aspects of the operation. It will not be the military commander's responsibility to establish the institutions. Still, he must insist on an interagency assessment on rule of law issues so that an interagency plan can be developed and the military's role defined.

4-44. Commanders should seek ways to promote consent by giving the people, parties, and local institutions a stake in the peace process. Information regarding consent should be disseminated throughout the various parties' leadership at all levels. When a decision is reached with one leader, all must be aware of this decision as soon as possible. Joint Military Commissions, liaison officers, media broadcasts, and leaders throughout the force are key means to promote consent and transmit agreements concerning consent.

4-45. Consent can be lost if one side perceives the peace operations force to favor the other side. Loss of consent in a peacekeeping operation may lead to an escalation of violence and profoundly change the nature of the operation. Any decline of consent is therefore of concern to the peace operation commander and may unfavorably influence how the campaign develops. A lightly armed force specifically organized and equipped for peacekeeping will be incapable of containing the escalating situation caused by the loss of consent.

If the political body that authorized the operation desires to enforce a peace, then it must change the mandate and deploy a force capable of offensive and defensive operations. This will be a significant operational adjustment unless the force was deployed under a Chapter VII (of the UN Charter) mandate (peace enforcement) and was configured for combat.

4-46. If consent develops and all sides demonstrate their commitment to the peace process through acts and deeds, then a force organized and deployed as a PE force can gradually introduce those techniques appropriate to peacekeeping. For example, the NATO led Implementation Force (IFOR) entered Bosnia as a PE force under a Chapter VII mandate. Under Stabilization Force (SFOR), the force is gradually using peacekeeping techniques in areas where compliance and consent exist. However, the mandate remains unchanged and SFOR retains its combat power and authority.

IMPARTIALITY

4-47. Impartiality is a fundamental of peace operations that distinguishes PO from offensive and defensive combat operations. Impartiality requires the PO force to act on behalf of the peace process and mandate, showing no preference for any faction or group over another. Corrective actions are taken for noncompliance rather than a desire to support or oppose a particular party. Figure 4-1 illustrates that in war impartiality is not an issue, and that ultimately the terms of any peace plan could be imposed on the belligerents (enemy) without consultation or agreement.

4-48. The degree to which the force acts in an impartial manner and the degree to which the belligerent parties perceive the force to be impartial influence a peace operation. Even-handed treatment of all sides in the conflict can improve the prospects for lasting peace and security, even when combat operations are underway. Compromised impartiality may trigger an uncontrollable escalation from a PK operation to a PE operation, or from a PE operation to a conflict situation, by adversely affecting consent and jeopardizing the success of any peace operation.

4-49. Forces, whether peacekeeping or peace enforcement, must always strive to be impartial and use information operations to support this perception among the populace and various parties. Impartiality should not be confused with neutrality. An analogy can help to relate impartiality to the conduct of operations: the impartial status of a legal system is not compromised because it only punishes the guilty, though that may not be the perception of a career criminal. Therefore, using force, even when applied in an even-handed manner, is unlikely to be perceived as such, especially by any party that persistently transgresses. Thus, the power of information must be brought to bear, and the fundamental of transparency becomes all-important.

TRANSPARENCY

4-50. Transparency means that the peace operation force must communicate its intentions and capabilities to all audiences inside and outside the area of operations. This differs from offensive and defensive operations when the force conceals its intentions and capabilities. PE forces must make the parties and the populace aware of the operational mandate, mission, intentions,

and techniques used to ensure compliance. Transparency serves to reinforce legitimacy and impartiality. It is more difficult to challenge the impartial status of an operation if the parties are kept informed. A failure to communicate will foster suspicion and may erode the development of the trust and confidence on which the long-term success of the operations depends. Integrated and synchronized information operations are necessary to facilitate transparency. Civil-military programs, joint commissions, and an effective liaison system reinforce transparency. The need for transparency must be balanced against the need for operations security. Some instances may exist, especially in a peace enforcement operation, that security may initially preclude the complete sharing of information. However, protocols are established to share as much information as possible.

RESTRAINT

4-51. In PO, restraint is an exercise in the prudent and appropriate application of military capability. Restraints on weaponry, tactics, and levels of violence characterize the environment of peace operations. While PK is usually nonviolent, PE may include violent offensive and defensive operations. The use of excessive force may adversely affect efforts to gain or maintain legitimacy and impede the attainment of both short- and long-term goals. On the other hand, appropriately using force to prevent factional groups from destroying the peace process can strengthen consent. These restraints should be clearly spelled out in the ROE provided for the operation by higher authority. Commanders strive for full situational understanding to determine how best to use this force.

4-52. In PK, force is used only in self-defense. In PE, force may be used to coerce (see Figure 4-1). It may have far-reaching international political consequences. Use of force may attract a response in kind. It may also escalate tension and violence in the local area and embroil peace operations troops in a harmful, long-term conflict contrary to their aims. For that reason, use of force should be a last resort and, whenever possible, should be used when other means of persuasion are exhausted. Use of force is a critical planning concern. To be a credible deterrent, PO units must deploy with sufficient combat capability tailored to circumstances of that particular peace operation.

4-53. Commanders should always seek to de-escalate and not inflame an incident or crisis. Alternatives to force should be fully explored before armed action is taken. They include negotiation (see Appendix E), which may be used to reconcile opponents, both to one another and to the peace operations force.

4-54. Restraint does not preclude the application of sufficient or overwhelming force when required to establish dominance, to display US resolve and commitment, to protect US or indigenous lives and property, or to accomplish other critical objectives. The fundamental of restraint will permeate considerations concerning ROE, the choice of weapons and equipment, and control measures such as weapon control status. When force is used, it should be precise and overwhelming to minimize friendly and noncombatant casualties and collateral damage.

CREDIBILITY

4-55. A credible force is essential to ensure mission accomplishment. Credibility reflects the warring faction's assessment of the capability of the PO force to accomplish its mission. The force must have the proper structure and resources with appropriate ROE to accomplish the mandate. It discharges its duties swiftly and firmly, leaving no doubt as to its capabilities and commitment. All personnel consistently demonstrate the highest standards of discipline, control, and professional behavior on and off duty.

4-56. Nations contributing to the peace operation force should demonstrate their political will to see the mission through to its end. If nations withdraw their support or fail to provide assets in a timely manner, credibility will be weakened. Information operations promote credibility not just in the area of operations but also in the international community.

FREEDOM OF MOVEMENT

4-57. Freedom of movement equates to maintaining the initiative. As amplified in the mandate, no restrictions are allowed against the movement of the peace force or of the civilian population. Attempts by the parties to impose increased restrictions reflect lessened consent. Freedom of movement is a necessary condition for the peace process to move forward. If the parties persist in denying freedom of movement, the authorizing political organization must assess the situation to determine if the mandate must change or the force must withdraw.

FLEXIBILITY

4-58. The complex multinational and interagency environment in which US forces conduct peace operations require commanders at all levels to place a premium on initiative and flexibility. Commanders and staffs must continually analyze their mission in the changing political context, and change tasks, missions, and operations as appropriate. The successful transition to peace involves managing change. Forces should be able to adapt and move from one activity to another on short notice. Tailoring the force enhances flexibility by providing for a force properly balanced for the mission in terms of skills, capabilities, equipment, and logistics.

CIVIL-MILITARY OPERATIONS

4-59. Military and civilian organizations have always interacted with each other. As a central feature of peace operations, CMO help harmonize civilian and military activities to maximize the use of resources designed to redress the deprivation and suffering of the people. CMO enhance the credibility of the friendly force. They promote consent and legitimacy and encourage the parties of the conflict to work toward a peaceful settlement.

4-60. Humanitarian assistance will be a part of many peace operations. Humanitarian assistance can significantly impact resources required and other aspects of these operations. In peace operations, humanitarian assistance encourages stability that reduces the civilian dependency on external military assistance.

4-61. Early in the peace operation, critical and immediate tasks normally carried out by civilian organizations may have to be performed by the military or with substantial military cooperation when the situation has temporarily exceeded their capabilities. In these situations, the PO force provides immediate relief and helps to create a sustainable infrastructure. Forces may also be required to prevent hostile, uncooperative, or criminally-oriented groups from gaining control of services, facilities, administrative posts or sectors of the economy. The same force will require civil affairs assistance when dealing with a large number of refugees; displaced persons; UN and non-governmental organizations; and local, regional, and national civil authorities.

4-62. CMO in peace operations should focus on empowering civilian agencies and organizations to assume full authority for implementing the civil portion of the peace effort. As the operation progresses, civilian organizations should assume greater responsibilities for civil functions and require less assistance from the military force. The relationships established in the initial stages coupled with accurate assessments of progress achieved in civil-military implementation are crucial to smoothly transitioning responsibility and ultimately extracting the force. Plans for transition and termination should be completed before deployment or as soon as possible during the initial phase.

4-63. PO seek to restore peace by promoting national reconciliation and often establishing or reestablishing effective government. The military often achieves its military objectives quickly, but the completion of the mission and its departure force invariably depend on progress in the civil arena.

4-64. Leaders use military assets sparingly when civilian assets are more appropriate in promoting the overall objectives of the mission. For example, Army assets may be able to repair a road quickly and efficiently, but providing work to unemployed civilians may be a better solution. Such a decision promotes support for the political settlement that the mission is seeking to implement.

4-65. Often coherence and accountability are best achieved by working through the appropriate lead international organization. A lead agency is one that the international community has mandated to initiate coordinating the activities of the civilian organizations that volunteer to participate in a mission. It is normally a major relief agency. Specific responsibilities of a lead agency are—

- Acting as a point of contact for other agencies, particularly in the areas of planning and information sharing.
- Coordinating field activities to avoid duplicating effort and wasting resources.
- Interfacing with the military.

4-66. The best way to understand the skills, knowledge, and capabilities of international organizations, NGOs, and US government agencies is to maintain relationships with them before entering a mission. Including civilian agency personnel in selected field training exercises effectively aids to develop working relationships based on trust and understanding. Commanders should press for such team-building exercises with all entities before deploying on a mission.

4-67. Many partners from the international community, such as international organizations and NGOs, contribute to achieving the purpose of a peace operation. However, the roles of indigenous leaders and organizations should not be overlooked. Appropriately involving local institutions and agencies with the international effort is a challenging but essential task.

LEGITIMACY

4-68. Legitimacy is required to sustain the willing acceptance by the people of the right of the government to govern, or a group or agency to make and carry out decisions. It is a condition growing from the perception of a specific audience of the legality, morality, and correctness of a set of actions. It is initially derived from the mandate authorizing and directing the conduct of operations. However, the perception of legitimacy can only be sustained with the US public, US forces, indigenous parties, and the international community if operations are conducted with scrupulous regard for international norms on the use of military forces and regard for the humanitarian principles. Commanders must be aware of the authority under which they operate and the relationship between it and the other sources of legitimacy that are present. During operations where a clearly legitimate government does not exist, using extreme caution in dealing with individuals and organizations will avoid inadvertently legitimizing them. Conducting information operations, to include the related activity of public affairs, can enhance both domestic and international perceptions of the legitimacy of an operation. Legitimacy also reinforces the morale of the PO force.

PERSEVERANCE

4-69. PO forces must be prepared for the measured, sustained application of military capability in support of strategic aims. While some peace operations may be of short duration, most require long-term commitment that involves more than military efforts alone. Underlying causes of confrontation and conflict rarely have a clear beginning or a decisive resolution. Commanders need to assess actions against their contribution to long-term strategic objectives.

4-70. Perseverance requires an information strategy that clearly explains the goals, objectives, and desired end states and links them with US interests and concerns. The long-term nature of many peace operations must be continually emphasized without giving the impression of permanency.

COMMAND AND CONTROL

4-71. Commanders in peace operations must marshal all their experience, knowledge, skill, and wisdom to succeed. They must often operate outside the hierarchical structures to which they are accustomed. Command and control (C2) in peace operations often entails complex arrangements and relationships. Mutual trust is a necessity.

It's all about trust—up, down, and all around.

Major General C. F. Ernst

COMMAND RELATIONSHIPS

4-72. US military forces will normally operate as part of a multinational peace force and apply the principles and considerations found in JP 3-16 and FM 3-16. The preferred command relationship in PEO is lead nation or lead alliance. This provides the peace force commander with the maximum control of forces where the risk may be high.

4-73. Three levels of authority govern UN peace operations. Overall political direction and authority belong to the Security Council. Executive direction and control rest with the Secretary-General. Field authority rests with the UN Chief of Mission. Thus, the line of authority for UN operations runs from the Security Council to the Secretary-General to the UN Chief of Mission. Appendix A contains definitions of command relationships and more details on UN organization.

4-74. For military observers assigned to UN peacekeeping duties, the direct line of command goes to the office of the US Military Observer Group—Washington (under the Deputy Chief of Staff for Operations on the Army Staff). If small contingents are assigned to UN duty, their chain of command will likely run through a combatant commander.

4-75. Leaders at all levels should understand the key documents related to the PO mission. These documents include—

- ROE.
- Peace agreement.
- International organization mandate (NATO, UN).
- Terms of reference and military-to-military agreements.
- Status-of-forces agreements.
- Status of mission agreements.
- Memorandums of understanding (MOUs).

4-76. Parties involved in the conflict will challenge leaders at every level. Peace agreements that were signed by political leaders may not have the support or consent of all the people of the region. Consequently, situations arise where individuals challenge the very existence of the agreed upon documents. Leaders at every echelon must be familiar with these documents to perform their mission.

4-77. The role of the senior US commander in PO is more extensive than what would be expected. It will encompass the full spectrum of threat, political, and information dimensions of the operational environment. The commander and his force must be prepared to adapt to this complex and fluid environment.

COORDINATION

4-78. Coordinated Pol-Mil plans are essential for success in all peace operations and provide the civil-military interface that synchronizes the efforts of the various agencies assisting the peace process. Whether objectives are humanitarian, political, or military, synchronization of effort is essential. Combatant commanders usually include the Pol-Mil plan in their plans. The Pol-Mil plan is drawn from the national-level Pol-Mil plan and takes into

account the goals and objectives of the various agencies assisting the peace plan. (National-level interagency coordination is described in Appendix A.) Perseverance aids in synchronizing the efforts of all involved. Competing agendas create situations where synchronization can break down. The military must keep focused but remain adaptable and work toward the end state. Annex A to Appendix B in JP 3-57 contains a sample Political-Military Plan.

4-79. The CMOC, or equivalent function, helps facilitate coordination between the civilian and military elements. Lessons learned from PO have shown that comprehensive civil-military coordination in peace operations can—

- Harmonize military and civilian implementation and planning.
- Ensure the unity of effort.
- Streamline transfer of authority.
- Enhance relations with international organizations and NGOs.
- Eliminate duplication of effort.
- Eliminate confusion.

INTELLIGENCE

4-80. Intelligence collection and production is challenging in peace operations. The situation in the area of operations often reflects a convoluted historical process. The area may be remote. The intelligence community may not have thoroughly studied it before deployment. Although the methodology for collecting intelligence is generally the same as it is in other military operations, the focus and the sources are often quite different. In PO, the intelligence operation must help to collect—then fuse—political, criminal, economic, linguistic, demographic, ethnic, psychological, and other information regarding conditions and forces that influence the society. The sources of information will be nontraditional and include open sources. These sources can be travel agencies and commercial ventures as well as international organizations and NGOs that have most likely been engaged in the area before the arrival of Army forces.

PRINCIPLES OF INTELLIGENCE AND ELECTRONIC WARFARE SUPPORT

4-81. The principles of intelligence and electronic warfare operations outlined in FM 2-91.1 apply in PO. Several principles contribute to the success of intelligence support to peace operations:

- **Human intelligence.** Human intelligence (HUMINT) is the dominant discipline in peace operations. It has broad focus, collecting against all participants, to support not only the military operation but also the political processes in which the military is involved. The collection may be conducted by a multinational HUMINT organization as well as national assets thus presenting challenges to integration and synchronization. This is especially important when it comes to counterintelligence and force protection. To be successful, HUMINT operations must commence as soon as possible, ideally before the arrival of the main force.
- **Intelligence synchronization.** Although important in any military operation, synchronization takes on a broader dimension in a peace

operation. Due to the multinational and civil dimensions of peace operations, the intelligence system must consider multinational participants, many of who do not have information sharing agreements with the US. The intelligence system must give special attention to integrating NGOs, information operations (IO), and host nations into the process.

- **Tactical tailoring.** Intelligence architecture must be task organized. Traditional architecture does not normally broadcast national-level intelligence to the tactical level. However, that is the type of information that the tactical commander needs during PO. Military intelligence units and organizations must adapt their traditional wartime structure to meet the specific demands of a peace operation. PO often require liaison with and support to organizations that normally would not get liaison. Local civil, military, and police authorities; NGOs; international organizations; and UN organizations must be included in the information loop. Tailoring the intelligence structure to accommodate these critical links to information often requires economy of force elsewhere.
- **Broadcast dissemination.** Broadcast dissemination in peace operations facilitates the “push” of information to commanders in the field. Commanders must ensure that broadcast dissemination encompasses the various coalition command, control, communication, and intelligence architecture, while maintaining information security and information assurance guidelines. This becomes especially challenging when working with coalition partners with whom the US does not have information sharing agreements. The media must also be considered a tool for dissemination as well as collection. Commanders must be willing to adapt the system to function in coalition architectures as well as civil structures in accordance with releasability guidance.

INTELLIGENCE FUNCTIONS

Indications and Warning

4-82. The commander monitors potential situations that affect the mandate of the forces. Change can come from a friendly government, a belligerent, a neutral, or from the political leadership. The commander should stay abreast of breaking news events. Because these events can have significant political and strategic impacts, the intelligence staff works closely with the information operations cell and the planning staff.

Intelligence Preparation of the Battlefield

4-83. Intelligence preparation of the battlefield (IPB) is a continuous process that includes gathering information on areas in which a unit might be required to operate (see FM 2-01.3). It begins before deployment notification and may be based on open-source intelligence. When notification comes, having current information will reduce uncertainties regarding the adversaries, the environment—including the medical threat and terrain in a given area—and facilitate mission planning. Successful intelligence support during PO relies on continuous information collection and intelligence production.

4-84. Ground reconnaissance and meetings with key interagency, international organization, and NGO players are essential to IPB. The information gathering should focus on areas that influence people, such as cultures, politics, religion, economics, and related factors and any variances in affected groups of people.

4-85. IPB must be developed in sufficient detail to support information operations. Based on the breadth of information collected, pattern analysis, which includes links and nodes, will be useful to the information operations cell for nonlethal—and, if necessary, lethal—targeting.

Situational Development

4-86. PO present challenges to maintaining a common operational picture. The long-term nature of PO means that the situational development effort will be long term. Analysts must consider “soft” political issues, civilian attitudes, refugee movements, and the agendas of the friendly partners in the PO. Predictive intelligence ensures that operations continue and initiative is sustained. Anticipation is the watchword. It will be a key challenge because the analysts must deal with the attitudes and behaviors of the people.

Targeting and Target Development

4-87. The focus in peace operations is to integrate all aspects of military power with nonmilitary instruments to achieve success. Such activities as civic action, infrastructure support, and public relations events should be considered part of the targeting process. The concept of target and weapon system must be expanded. Most targets will be engaged with nonlethal means. The concept of target and weapon system must be expanded. High-value and high-payoff target lists must focus on changing the behaviors of target audiences. The effects on the target itself are not as important as the effects on the target audience.

4-88. Targets can include civil and military leaders who control or influence the local population or the assets that these leaders use to achieve their ends. For example, if the leaders are trying to turn a legal political rally into a riot, then the radio broadcasts, loudspeaker vans, or even the busses to transport troublemakers to the rally become targets.

4-89. Assessment in peace operations is a challenge. The difficult issue in peace operations is that the “target” is soft and does not fit neatly into the criterion of damage assessment. Many times the results are psychological and do not manifest themselves until weeks or months after the events. HUMINT along with patience are critical.

Support for Force Protection

4-90. Early coordination for intelligence support to protect the force should be conducted with allies, partners, and the host nation. The intelligence support must balance with the requirements for transparency and impartiality. Additionally, the issue of intelligence sharing must be solved.

INFORMATION OPERATIONS

4-91. Offensive IO, including the use of the related activities of public affairs and CMO, strengthen both consent and the legitimacy of the operation through the fundamental of transparency. The impartiality of the force must be maintained and conditions created to strengthen consent where it exists and to create it where it does not. In peace operations, offensive IO influence the behavior of people to work toward reconciliation and rebuilding. Information is the peace operations commander's primary means to influence groups of people to change attitudes and behavior. IO can affect the center of gravity directly. All sides understand the potential of information and will attempt its exploitation.

NATURE OF INFORMATION OPERATIONS

4-92. In PO, the military commander cannot exercise the degree of control over the information environment that he can in war. The fundamentals of transparency and legitimacy demand that he engage openly within this complex environment.

4-93. The PO force will be a latecomer to a situation that has a long, complex, and convoluted history. The various factions will have been using information as a weapon through censorship, propaganda, and disinformation. The local, as well as the international, media will usually be operating before the forces arrive and may be one of the causative factors in the military's engagement.

4-94. Additionally, allies and partner countries participating in multinational force may have troops engaged before US military involvement. The operational area will not be a blank tablet. Information superiority will be transitory in this environment, making absolute and sustained superiority impossible.

4-95. The commander must carefully consider the effects of IO before taking action. Destroying a belligerent's electronic warfare capability may bring favorable tactical results, but it may also have a destabilizing effect on the peace process. Permitting belligerents to not only monitor activities of each other, but also of the PO force may provide the transparency that eases tension and increases trust.

4-96. The information environment will extend down to the man on the street and the soldier at the checkpoint. Individuals, by interacting directly with the media or on-line, can become a powerful source of information that can challenge the more traditional sources. Local events and the immediate impressions of individuals about those events can have international significance as the global media broadcasts them.

FUNDAMENTALS OF INFORMATION OPERATIONS IN PEACE OPERATIONS

4-97. *The commander sets the tone.* Although supported by a staff and IO coordinators and sections, the commander sets the tone and drives the operation on the basis of senior political guidance and approved public information themes. For IO to succeed, commanders must be involved. They must make this their personal focus so that the entire force can speak with one voice. Only commanders can provide the vision and the guidance that will unify the effort. In PO, commanders will often be the media's focus and chief

negotiators in sensitive situations. Some actions they can take to unify the effort include—

- Establishing commander's critical information requirements that are oriented around IO.
- Developing a media policy.
- Providing daily IO guidance.
- Implementing a decision cycle that supports IO. It must allow commanders to obtain situational understanding, perform the military decision making process, and issue appropriate guidance before meeting the media or entering negotiations.

4-98. The IO cell incorporates the relevant multinational participants. It ensures that IO fully integrate into the joint and multinational targeting process. Integration and synchronization should extend down to the individual soldier.

4-99. **Support IO with intelligence.** Without detailed intelligence that encompasses the complete spectrum of cultural, social, political, economic, and psychological issues focused on an individual, IO cannot be properly targeted. The IO planner will require such products as nodal and link analysis based on accurate and up-to-date intelligence.

4-100. **Establish and sustain an integrated team approach.** Successful IO require synchronizing all participants involved in the peace process. The combined effort must include nonmilitary agencies. Specifically, the public affairs office and the PSYOP staff must be integrated and have access to current and proposed military actions.

4-101. **Anticipate and respond with speed, accuracy, and truth.** Journalists provide immediate impressions and judgments while the military relies on verified information. For the military, accuracy overrides immediacy. However, perceptions can be formed and decisions can be made based on these initial impressions. Timing is essential in shaping perceptions. The public affairs officer must know operations as they unfold and be allowed to release information as quickly as possible.

4-102. **Involve every soldier.** The soldier is the Army's best ambassador. The most powerful way to influence populations is for every member of the force to be an information transmitter. Ensure that all members of the force understand the information operations plan and can articulate its themes to others.

4-103. **Maintain transparency.** Transparency supports legitimacy and assists in maintaining consent. Admiral Layton Smith, Commander IFOR, had this objective, "If we [IFOR] know, they [the media] know." Under these circumstances, disseminate information, including bad news and mistakes, as quickly as possible to gain and maintain credibility with the international media and the host nation.

4-104. **Gain and maintain access to the information environment.** The military force must actively participate in the information environment. The outside media will be present outside the military headquarters and

interested parties will be visiting the force's web site. The commander should consider developing an accessible web site.

4-105. ***Prepare for IO before deployment.*** The belligerent parties will have been waging an information campaign long before involving the Army. Army forces should not wait until they receive deployment orders to begin to address the informational aspects of the operation and hope to gain the initiative. Commanders should consider predeployment preparation, anticipating future involvement in PO.

CIVIL LAW AND ORDER

4-106. The rule of law is fundamental to peace and stability. A safe and secure environment maintained by a civilian law enforcement system must exist and operate in accordance with internationally recognized standards and with respect for internationally recognized human rights and freedoms. Civilian organizations are responsible for civil law and order. However, Army forces may need to provide limited support.

POLICE

4-107. To secure public order, the host nation or responsible international authority requests introducing civilian police and establishing a police training element such as the International Police Training Force in Bosnia. The International Crime Investigative Training Assistance Program from the Department of Justice may be used. International civilian police do not ordinarily exercise executive authority, but rather monitor and mentor local police. When the indigenous security and police forces are nonexistent or incapable and international police training programs cannot generate sufficient resources quickly enough, the military may be required to assist. The military commander should consider requesting civil law enforcement units from member nations of the multinational force to take the lead in these missions. This allows the military police to continue other high priority missions. This gives the commander an advantage in dealing with the legal and practical issue of what is essentially a civil police issue.

Civilian Administration

During Operation JOINT GUARD in Kosovo, until a complete code of law was established, KFOR forces, in conjunction with the UN, served as the civil police force until UN Mission in Kosovo Police (UNMIK-P) was established in sufficient numbers. Each multinational force maintained its own detention facility for local detainees. Local magistrates, lawyers, and peacekeeping forces oversaw the judicial system. These facilities were also open to the inspection of international organizations such as the Organization for the Security and Cooperation in Europe and International Red Cross. The US forces assigned only military police to these duties.

JUDICIARY

4-108. Army forces may assist in establishing a workable judicial system with judge advocate general (JAG) and CA support. The law standards to be

used and their effect on SOFAs and MOUs will be important considerations. The commander's legal and political advisors should be engaged in developing the system to ensure that military concerns are addressed.

PENAL

4-109. Army forces may be required to establish and run temporary confinement facilities until civilian agencies take the lead. The engineer and military police community should be prepared to deal with temporarily confining civilian prisoners accused of civil crimes. Consideration should be given to deploying the soldiers holding appropriate military occupational specialty for confinement duties. The international community should establish standards and rules of confinement during the planning phase to allow proper preparation.

WAR CRIMES AND CRIMINALS

4-110. War crimes and corruption can jeopardize the accomplishment of the PO force's objectives and prevent its timely withdrawal. As previously discussed, peace without justice undermines consent and can affect the entire peace process. Although controlling corruption and organized crime is primarily the responsibility of the host nation and the civilian police, the military has capabilities—such as intelligence, communications, and the ability to provide a security presence—that can help.

4-111. The term *war crime* is sometimes used to describe a violation of the law of war. In peace operations, US forces apply the principles and spirit of the law of war to the extent practicable and feasible, even when a state of war does not exist. US forces will comply with the law of war while conducting all military operations and related activities in armed conflict.

4-112. The UN Security Council may decide to establish a commission or other body to investigate alleged war crimes. If the allegations appear to be true, the Security Council may establish or help create a tribunal to prosecute the offenders. If the host nation is unwilling or incapable of bringing the alleged war criminal to justice, then the civilian police and Army forces may be called on to assist in detecting, apprehending, and transporting these individuals to the tribunal. Planning for these operations is detailed and should include JAG and public affairs officer participation. An additional consideration is that all nations in a multinational force may not agree to a role concerning war crimes and war criminals.

LOGISTICS

4-113. Logistics is as challenging in PO as it is in war. The logistics and combat service support planning considerations presented in Chapter 2 apply to peace operations. FM 3-16 and JP 3-16 are also excellent references for logistic considerations in stability operations and support operations. The following paragraphs contain additional considerations for PO.

4-114. The US military has the following capabilities that are frequently requested in support of PO:

- Rapid C2 and logistics planning capability.

- Strategic and tactical airlift.
- Emergency infrastructure repair and support (port, airfield, road).

4-115. Army forces will usually conduct PO as part of a joint, multinational, and interagency effort. Logistics must operate with multinational forces and civilian organizations. Additionally, the military force may also provide support to the host nation. Army forces should establish a CMOC to coordinate support with nonmilitary agencies. The location of this entity will greatly influence its effectiveness (see paragraph A-79).

4-116. Early in the planning process, the commander of the peace operations force must receive guidance on the authority to direct logistics. The Army commander involved in the peace operation must know what authority will be delegated to him. If the force is multinational, the scope of that authority must be appropriate to meet the needs of a multinational effort.

4-117. The Army is responsible for the logistic support of its own forces, except when logistic support is otherwise provided for by agreement with national agencies, multinational partners, or by assignments to common, joint, or cross-servicing agreements. The authority for logistics must be considered in the context of STANAG (Standard NATO Agreements), Foreign Military Sales, agreements under the NATO Mutual Support Act, and other bilateral and multinational agreements.

FORCE PROTECTION

4-118. Force protection measures directly relate to mission accomplishment. They should enhance consensus and assist in creating the conditions for other political, economic, and humanitarian peace building activities to achieve the political objectives.

4-119. In PO, force protection measures should be consistent with the risk assessment, but they should not be excessive. A level of force protection that exceeds the risk assessment sends a psychological signal to the population that they are still in a tense and uncertain environment. It may retard the return to normalcy and the establishment of conditions that will prevent the peace process from continuing. Additionally, it can limit the contact between the force and local population, reducing the force's capability to gather HUMINT and the ability of the force to mitigate tense situations through negotiations.

4-120. Civilian organizations, the media, and others may request the military force to provide security. Although this security is not technically "force protection," it may serve to enhance credibility with these groups and potentially provide the commander with an opportunity to advance cooperation.

4-121. Maintaining neutrality and transparency in operations enhances force protection. However, personal awareness is the most proactive measure. This awareness is based on an education, training, and preparation program that acquaints the soldier with the culture and the environment.

Chapter 5

Additional Stability Operations

This chapter discusses stability operations that separate chapters in this manual do not address. Several operations in this chapter—security assistance, combatting terrorism, and show of force—may involve Army units or individuals but are not tactical tasks. However, Army forces participate in them in support of national or strategic objectives. The foundations of stability operations and support operations discussed in Chapter 1 also apply to these operations.

SECURITY ASSISTANCE

5-1. Security assistance (SA) includes the participation by Army forces in any of a group of programs authorized by the Foreign Assistance Act of 1961, as amended; the Arms Export Control Act of 1976, as amended; or other related statutes. SA is the means through which the United States (US) provides defense articles, military training, and other defense-related services to eligible foreign governments or international organizations by grant, loan, credit, or cash sales to further US national policies and objectives. These programs include foreign military sales, and international military education and training. SA is a group of programs, not a mission assigned to Army units. However, Army units and soldiers participate in SA programs through peacetime military engagement activities and by training, advising, and assisting allied and friendly armed forces.

EQUIPMENT, SERVICES, AND TRAINING

5-2. SA programs furnish countries with the equipment, services, and training to defend themselves from aggression and enable them to operate alongside US forces in a multinational effort. Providing vital training and US-manufactured weapon systems increases access and influence of the military and improves the interoperability of potential coalition members. In addition, these contacts help build and solidify relationships with emerging

CONTENTS

Security Assistance	5-1	Planning Considerations	5-10
Equipment, Services, and Training	5-1	Combatting Terrorism	5-11
Types of Programs	5-3	Counterterrorism	5-12
Agencies and Organizations	5-4	Antiterrorism	5-12
Humanitarian and Civic Assistance	5-5	Noncombatant Evacuation Operations	5-13
Support to Insurgency	5-6	Arms Control	5-16
Support to Counterdrug Operations	5-6	Show of Force	5-17
Types of Support	5-8		

democracies and security partners. SA can also deter aggression in unstable regions and provide a cost-effective alternative to maintaining larger US forces in a region.

Equipment

5-3. Regional threats determine the general equipment needs of the supported host nation (HN). Each security assistance organization (SAO) will coordinate military equipment requests with the combatant commander and the US embassy country team. The theater security cooperation plan—developed by the regional commander of a combatant command—provides recommendations (through the joint staff) to the Department of Defense (DOD) on appropriate types of equipment to provide and its distribution. Commanders must consider that—

- If equipment in the US inventory is inappropriate for host-nation use, a nonstandard item may fill the requirement. However, commanders must consider sustainability of nonstandard equipment, as well as interoperability with existing equipment.
- HNs may request expensive equipment as a status symbol of regional military power. This is done even when improved training and professionalism among the existing force would best enhance the overall strength of the military. This is a delicate political situation that the ambassador and combatant command should address.

Services

5-4. Service support is usually integrated with equipment support. It includes any service, test, inspection, repair, training, publication, technical assistance, or other assistance or defense information used to furnish military assistance. Many types of service teams exist, for example, those that provide quality assurance and technical assistance. Quality assurance teams inspect equipment to ensure it remains mission capable. Such teams are intended only for short-term use. Technical assistance teams respond when the HN has difficulty with US-supplied equipment. For more details, see DOD 5105.38-M.

Training

5-5. This portion of SA can significantly impact the host-nation internal defense and development program. SA training programs—

- Create skills needed for effective operations and maintenance of equipment.
- Assist the HN in developing expertise and systems needed for effectively managing its defense establishment.
- Foster development by the HN of its own training capability.
- Promote military-to-military understanding, which leads to increased rationalization, standardization, and interoperability.

5-6. There are four primary methods of training:

- Mobile training teams are used when a host-nation element requires on-site training or needs surveys and assessments of training requirements. These teams may be single-service, joint, special operations

forces, or conventional forces, but they are tailored for the training the HN requires. A mobile training team is employed temporarily for a period not to exceed 179 days.

- Extended training service specialist teams are employed on a permanent change of station to assist the HN in attaining readiness on weapons or other equipment. These teams train the host nation's initial instructor cadre so that the HN can assume responsibility for training.
- Technical assistance field teams are also deployed on a permanent change of station basis and train host-nation personnel in equipment-specific military skills.
- International military education and training and mobile education teams provide host-nation personnel with training opportunities in the continental US and in the HN. This training not only meets the immediate host-nation requirement of increased training, but also has a longer-term impact of improving US-HN relations.

TYPES OF PROGRAMS

5-7. The military components of SA in which the DOD is involved include foreign military sales, the foreign military financing program, the international military education and training program, and some peace operations. The DOD implements these components in accordance with policies established by the Department of State (DOS).

5-8. Foreign military sales is a major security assistance program that permits government-to-government sales of defense articles and defense services, including training. Subject to the provisions of the Arms Export Control Act and the international traffic in arms regulations, foreign governments may also purchase military equipment and services directly from US defense industry contractors. Appendix B further discusses the Arms Export Control Act.

5-9. Foreign military financing program (FMFP) provides funding to purchase defense articles and services, design and construction services, and training through foreign military sales or through commercial channels. The FMFP can be an extremely effective foreign internal defense (FID) tool, providing assistance to nations with weak economies that would otherwise be unable to afford US assistance.

5-10. International military education and training program provides training to selected foreign military and civilian personnel on a low-cost, grant aid basis. This program has long-term, positive effects on the relations of US and supported nations and on the development of strong and stable military infrastructures. It allows the US to develop channels for communications with foreign military and civilian personnel worldwide.

5-11. The peacekeeping operations program funds activities. These activities include peacekeeping operations such as the multinational force and observers in the Sinai and the Organization for Security Cooperations in Europe. Although related to FID, these operations are a part of SA given their separate activities and very focused goals and objectives.

5-12. Excess defense articles may be transferred by the US government to foreign governments as a form of security assistance through the provisions of the Foreign Assistance Act (FAA). By nature, this program depends entirely on the military service's decisions regarding what equipment is excess to their needs, as defined in the FAA. Also, excess equipment is not available for transfer to foreign recipients until it has first been offered to eligible US recipients as designated in the act.

5-13. Drawdown authority may be used for unforeseen emergencies, when requirements cannot be met under the authority of the Arms Control Export Act, or when the president determines that it is in the national interest. Under drawdown authority, the US government is authorized to draw down articles and services from the inventory and resources of government agencies to meet the needs and purposes as outlined in the FAA. This is particularly effective in times of urgent humanitarian need when appropriated funds are not readily available. It is another tool for promoting US commitment to peace and stability in a region.

AGENCIES AND ORGANIZATIONS

5-14. The chief agencies involved in SA activities are the DOS, the DOD, and the military departments. Appendix A discusses roles and responsibilities of these organizations. SA is subject to the continuous supervision and general direction of the DOS, as well as congressional oversight. The undersecretary of state for arms control and international security affairs coordinates policies, plans, and programs of all departments and agencies involved in SA activities. US embassies and other diplomatic missions in host nations develop and implement US collective security programs.

5-15. The Defense Security Cooperation Agency oversees the execution of SA. This agency directs, administers, and supervises the execution of such SA programs through the military departments and geographic combatant commanders' SA divisions. The agency conducts international logistics and sales negotiations with foreign countries. It manages the credit-financing program and serves as the DOD focal point for liaison with US industry regarding SA activities. It provides the necessary guidance for program execution.

5-16. The geographic combatant commander nominates, and the secretary of defense appoints, a US defense representative. The contact officer works with both the US mission and the host-nation military forces. The combatant commander's role is critical in stability operations and support operations. He advises the Joint Chiefs of Staff on significant events in his area of responsibility. His perspective is both regional- and country-specific. He identifies and applies necessary resources to achieve US and foreign strategic policy goals in his region. These resources minimize the likelihood of US combat involvement. The service component commanders participate in the SA planning process, especially in training matters. They have a large role in executing and managing all relevant programs.

5-17. The Security Assistance Organization manages DOD security assistance functions in a friendly country. It oversees all foreign-based DOD elements with SA responsibilities in that country. See Appendix A for more information about the SAO. The SAO can provide only limited advisory and

training assistance from its own resources. This assistance primarily is provided by survey teams, mobile training teams, technical assistance field teams, technical assistance teams, language training detachments, weapon systems logistics offices, quality assurance teams, site survey and defense requirement survey teams, and other such teams and organizations.

HUMANITARIAN AND CIVIC ASSISTANCE

5-18. Under section 401 of Title 10 United States Code (USC), humanitarian and civic assistance (HCA) authorizes using US military forces to carry out humanitarian assistance projects and activities with military operations. These deployments are an integral aspect of maintaining a forward US military presence, ensuring operational readiness to respond to crises, and preparing the active and reserve components for their wartime mission. Forces may perform HCA in any foreign nation for which the Department of State has approved the provision of such assistance. Military service operation and maintenance funds subsidize these projects. Geographic combatant commanders decide which HCA projects are warranted in their areas of responsibility. An interagency policy coordinating committee grants assistance based on US policy. The director, Defense Security Cooperation Agency, is the DOD approval authority for all HCA projects coordinated through the interagency coordinating committee. In contrast to humanitarian and disaster relief conducted under Foreign Humanitarian Assistance, HCA are planned activities with specific budget limitations (Chapter 6 discusses Foreign Humanitarian Assistance). HCA can be executed concurrently with or as part of other stability operations, such as FID. Assistance provided under HCA is limited to—

- Medical, dental, and veterinary care provided in rural or underserved areas of a country.
- Construction of rudimentary surface transportation systems.
- Well drilling and construction of basic sanitation facilities.
- Rudimentary construction and repair of public facilities.

5-19. HCA incurring only minimal expenditures for incidental costs is defined as “de minimus” expenditures. Geographic combatant commanders determine if an expenditure is minimal for activities in countries under their respective areas of responsibility—

- In the exercise of the commander’s reasonable judgement.
- In light of the overall cost of the military operation in which such expenditure is incurred.
- For an activity which is merely incidental to the military operation.
- By taking into account the time spent on such activity during the course of the operation.
- By reflecting the congressional intent that modest activities not be subjected to the burdensome paperwork and other requirements.

For example, to establish a base camp the commander may order the opening of an access road through trees and underbrush for several hundred yards, but not the asphaltting of a road. A medical team may visit a village for a few hours, but not for the purpose of mass inoculations to the local populace.

SUPPORT TO INSURGENCY

5-20. On the president's order, Army forces support insurgencies that oppose regimes that threaten US interests or regional stability. While any Army force can be tasked to support an insurgency, Army special operations forces (ARSOF) usually receive these missions. ARSOF training, organization, and regional focus make them well suited for these operations. (See FM 3-05). Army forces supporting insurgencies may provide logistic and training support. They can, but normally do not, conduct combat operations.

5-21. Army forces do not create insurgencies; however, when directed, they support those already in existence. Army forces develop and sustain the supported insurgent or resistance organization and synchronize its activities to further US national security objectives.

5-22. The US may support an insurgency during a major theater war or smaller-scale contingency. It may support a citizen or partisan defense intended as a deterrent or a resistance or secessionist movement intended to change the existing political order. The types of operations in which US forces can assist insurgencies include—

- Recruiting, organizing, training, and equipping forces to perform unconventional warfare. Unconventional warfare includes—
 - Guerilla warfare.
 - Sabotage.
 - Subversion.
 - Intelligence activities.
 - Unconventional assisted recovery.
- Psychological operations (PSYOP).
- Clandestine penetration of hostile and denied airspace.
- Resupply operations.

SUPPORT TO COUNTERDRUG OPERATIONS

5-23. National Security Directive 221 identifies drug trafficking as a threat to national security. It is also a threat to the stability of many friendly nations. The Fiscal Year (FY) 1989 National Defense Authorization Act imposed specific responsibilities upon the Department of Defense in support of the national counterdrug (CD) effort. It forms the basis for much of the Army's support CD efforts under law and approved DOD plans. JP 3-07.4 details the threat and CD organiza-

tions, operations, planning, and execution. When operating inside the United States and its territories, CD operations are support operations and are subject to the limitations of the Posse Comitatus Act. When conducted outside the US and its territories, counterdrug operations are stability

Support to Counterdrug Operations

- Detection and monitoring
- Host nation support
- Command, control, communications, and computer
- Intelligence, planning, CSS, training and manpower
- Research, development, and acquisition
- Reconnaissance

operations. Whether operating in the US or in a host nation, Army forces do not engage in direct action during CD operations.

5-24. In CD operations, Army forces always support one or more governmental agencies or services such as the Coast Guard, Customs Service, DOS, Drug Enforcement Administration, or Border Patrol of the Immigration and Naturalization Service. Those agencies may carry out CD operations in the US or in foreign countries. Units that conduct these actions must fully understand the legal limits on acquiring information on civilians.

5-25. Two principles guide Army support to CD operations. The first principle is to use military capabilities both to benefit the supported agency and to train soldiers and units. The second is to ensure that military members do not become directly involved in law enforcement activities.

5-26. No standard organization exists for an Army force conducting support to CD operations. Mission analysis and the directives of higher headquarters influence the organization of Army forces. To optimize training and readiness, however, commanders employ their forces using standard task organizations.

5-27. Many organizations are involved in the national drug control effort. Figure 5-1 shows lead agencies and their responsibilities. The US Army Criminal Investigation Command conducts CD operations to detect, interdict, suppress, and monitor drug trafficking and user demand that directly or indirectly affect Army forces. The Army National Guard (ARNG) has a dual capacity to serve. Generally, the ARNG operates under Title 32 or state status. When federalized under Title 10 status, the ARNG performs active duty missions. The National Guard Bureau is the national-level agency of the ARNG that coordinates state or territory plans.

Lead Agencies	Responsibilities
DOD	<ul style="list-style-type: none"> • Detect and monitor aerial and maritime transit of illegal drugs into the US • Provide LEA and host nation support • Coordinate timely passing of data • Approve and fund state governors' plans for ARNG support to LEAs
Drug Enforcement Administration (DEA)	<ul style="list-style-type: none"> • Enforce laws and regulations on drugs and controlled substances • Investigate major interstate and international drug law violators • Enforce regulations on legal manufacture and distribution of controlled substances • Manage national drug intelligence • Coordinate LEA and international counterparts efforts
Federal Bureau of Investigation	<ul style="list-style-type: none"> • Investigate violations of criminal laws (concurrently with DEA) • Target major multijurisdictional trafficking organizations • Dismantle trafficking networks
US Attorneys	<ul style="list-style-type: none"> • Prosecute criminals • Prosecute violators of federal laws concerning, money laundering, drug trafficking, tax evasion, and violent and organized crime • Oversee Organized Crime Drug Enforcement Task Force activities
US Border Patrol	<ul style="list-style-type: none"> • Act as primary agency in land interdiction between US ports of entry

Figure 5-1. Lead Counterdrug Agencies and Their Responsibilities

Lead Agencies	Responsibilities
US Customs Service	<ul style="list-style-type: none"> • Lead in interdiction at land and sea US ports of entry and US territorial waters (with US Border Patrol as primary agency between ports of embarkation) • Co-lead (with Coast Guard) in air interdiction
US Coast Guard	<ul style="list-style-type: none"> • Lead in maritime interdiction • Co-lead (with Customs Service) in air interdiction
DOS – International Narcotics Matters and Law Enforcement Affairs	<ul style="list-style-type: none"> • Coordinate US international supply reduction strategies

Figure 5-1. Lead Counterdrug Agencies and Their Responsibilities (Continued)

5-28. Army forces may be employed in various civil or military actions in support of the geographic combatant commanders and law enforcement agencies (LEAs). These forces detect, monitor, and counter the production, trafficking, and use of illegal drugs and the infrastructure—personnel, materiel, and distribution systems—of illicit drug-trafficking entities.

5-29. “The Mansfield Amendment” to the Foreign Assistance Act (Title 22 USC, 2291[c][1]) contains a prohibition against US personnel performing foreign law enforcement activities overseas.

TYPES OF SUPPORT

Detection and Monitoring

5-30. Army forces contribute to the interdiction of illegal drugs by detecting and monitoring drug traffickers attempting to enter the US. Detection and monitoring (D&M) is the first phase in interdicting illegal drugs. D&M aims to provide early notification to and, as necessary, prolonged tracking of aerial and surface targets for appropriate LEAs. This enables the agencies to execute interceptions, searches, arrests of traffickers, and seizures of illegal drugs and illegally obtained property. Host nations also conduct interdiction operations with assistance from US D&M. The primary goal of land interdiction is to seize drugs, drug-related money, and illegal munitions and chemicals as they enter or leave the United States. During reconnaissance, line-watch operations, and checkpoints along and in proximity to the US border are used extensively. (See discussion of Reconnaissance in this chapter.)

Host-Nation Support

5-31. Army forces provide support indirectly through civilian agencies of the US government and the civilian or military organizations of the HN. Geographic combatant commanders must integrate and coordinate the mission categories of counterdrug support. Overseas, Army forces may engage in two kinds of support to foreign countries: security assistance and civil-military operations. Most of the CD efforts support US foreign internal defense initiatives. (See Chapter 3 for discussion of FID.)

5-32. SA support for CD operations includes equipment, services, and training. Host nations can obtain equipment from the United States to meet the threat to their internal defense and development. Services are sometimes provided as a follow-on to equipment support. The training element of SA is a significant means of assistance for host nations.

5-33. Civil-military operations can enhance US counterdrug operations in foreign countries through civil affairs (CA) and psychological operations. CA provides information and analysis on the host-nation drug culture and implications of carrying out assigned CD missions. It also supports bilateral cooperative programs; gathers information through contacts with host-nation personnel; and assists the host-nation CD effort to change attitudes towards drugs and drug traffickers. PSYOP provide information support and training in counterdrug operations. (Chapter 2 contains additional information about CA and PSYOP.)

Command, Control, Communications, and Computer Support

5-34. Army personnel and equipment may assist LEAs and host nations in designing, implementing, and integrating command, control, communications, and computer systems. Army personnel support national and departmental drug operations and LEA analytical centers. In addition, Army forces provide liaison to LEAs and host nations to facilitate the smooth and successful integration of military support.

Intelligence, Planning, CSS, Training, and Manpower Support

5-35. Army units and personnel provide intelligence support targeted at the full range of narcotics traffickers' operations. This support is provided through individual intelligence analysts (often using reserve component specialists) and tactical analysis teams. These teams co-locate with the US country team, in support of LEAs, and provide focused detection and monitoring on narcotics trafficking activities.

5-36. Planning support can be one of the most effective means of supporting the national CD effort. Army personnel support CD planning of both LEAs and host nations. Understanding the supported agency or host nation, its culture, and its people is critical. Planning support provided to LEAs must consider the organization's mission, current goals, structure or chain of command, measures of success, and even relationships with other government agencies or countries. Planning support provided to host nations is similar to that provided to LEAs. However, the host nation's culture, historical perspectives, political climate, and economic conditions are considered.

5-37. The Army can assist LEAs with logistics management and execution, including transportation, as a type of combat service support (CSS). Typical categories of support to agencies are executed under authority of Section 1004 of the FY 1991 National Defense Authorization Act (as amended). In CD operations, a major Army contribution has been providing LEAs with aerial and ground transportation. Army forces can provide supplies and field services directly, if authorized, or assist other agencies in procuring and managing them from other sources. Commanders who assist LEAs with transportation of evidence, seized property, or contraband must be aware

that a law enforcement officer must accompany the shipment to ensure continuity of the chain of custody.

5-38. Training support is provided to host nations and LEAs. Most training support to host nations is provided through SA funding. However, some programs conducted with host nations are not part of SA. Those include operations planning groups, joint and multinational exercises, and joint multinational exercises for training. The latter provide Army units with the opportunity to deploy to a host nation for training. They provide readiness benefit and promote interoperability between US Army and host-nation forces.

5-39. The Army may provide individuals or units in support of host-nation and interagency CD efforts. Categories of manpower support are eradication support and administrative support—including staff judge advocate officers, paralegal specialists, and accounting specialists—diver support, linguist support, liaison officers, inspection support, military police support, and intelligence analysts.

Reconnaissance

5-40. This mission category includes aerial and ground reconnaissance through various means such as observation or listening posts, foot or mounted patrols, fixed- and rotary-wing aircraft (including unmanned aerial vehicles equipped with sensors), and remote sensors. The mission of land reconnaissance is specifically intended to define the support that the DOD provides to US LEAs inside the United States. There are legal and regulatory restrictions on the military's role in protecting our borders. These restrictions constrain the scope of land reconnaissance executed by Army forces.

PLANNING CONSIDERATIONS

5-41. Because CD operations rely on current intelligence, planners must thoroughly understand the drug trafficking threat to plan successful CD operations. Since the drug threat is so inconsistent, CD planners consult the current intelligence sources for accurate and timely threat information. LEAs provide most information for the threat assessment. The G2 performs intelligence preparation of the battlefield before each mission. He still must modify it to account for the less predictable drug traffickers rather than for a doctrinally rigid threat.

5-42. Leaders must clearly distinguish what constitutes a valid target. The intelligence estimates will identify the most likely methods of delivery or transportation of drugs. Information—such as expected rate of speed, routes of suspects originating from particular areas, or descriptions of various known drug trafficking vehicles—will provide principal means of determining which targets law enforcement officials will pursue. This information is crucial to the success of the mission and should be relayed to all participants of the operation.

5-43. CD operations most often require applying the Mission Command philosophy outlined in FM 6-0. Mission command allows for centralized command and decentralized execution, which promote establishing a clear focus on the objectives while providing the tactical commander with the flexibility to adapt to the developing situation.

5-44. Officials must establish clear command and control relationships. Clear distinctions must exist to determine relationships or methods with and between armed forces, diplomatic agencies, other US agencies, such as the US Customs Service, the Drug Enforcement Administration, and other host-nation forces and agencies. However, the military chain of command must always be maintained within Army forces. Law enforcement officers will command Army soldiers.

5-45. All plans should include a method of assessing not only the success of the mission, but also where it can be improved. These lessons learned should be shared with all CD agencies. FM 6-0 discusses assessment of Army operations.

5-46. Because so many legal implications exist in CD operations, the staff judge advocate must review all CD plans. Commanders must ensure that military personnel involved in CD operations act according to legal and policy restrictions. Using military support may require special procedures. Such procedures ensure that legal proceedings resulting from interagency CD operations can be effectively prosecuted and will not be dismissed from court due to illegal or procedurally incorrect actions. Legal issues are addressed in Appendix B. Additionally, USC provisions are addressed in JP 3-07.4. Status-of-forces agreements should also be reviewed to legally protect soldiers participating in the operation.

5-47. Although commanders desire maximum communications interoperability, it might not be possible, especially when working closely with host-nation LEAs and military forces. Therefore, planning for alternative communication methods is essential. Operators should know which systems supporting agencies and host nations are using and be familiar with each system's capabilities and limitations. They should also plan for back-up systems and methods.

5-48. Every effort should be made to prevent inadvertently sharing information on CD operations with trafficking organizations or their informants. Operations security (OPSEC) is crucial during all CD operations. Because CD operations are repeated, often from the same site, OPSEC surveys of the operations should periodically be accomplished.

COMBATTING TERRORISM

5-49. *Terrorism* is the calculated use of unlawful violence or threat of unlawful violence; intended to coerce or to intimidate governments or societies in the pursuit of goals that are generally political, religious, or ideological (JP 1-02). Combatting terrorism (CBT) involves opposing terrorist actions across the threat spectrum. These actions have both offensive and defensive components. The offensive form of action is counterterrorism (CT). The defensive form of action is antiterrorism (AT).

5-50. Although the Department of Defense is not the lead federal agency for conducting CBT, Army personnel and units conduct CT operations anywhere in the world. Normally, the DOS is the lead agency for incidents outside the US. The Department of Justice is normally the lead agency for incidents

within the US. AT is a normal part of force protection; Army commanders at all echelons must protect their soldiers, equipment, and installations.

COUNTERTERRORISM

5-51. CT usually involves offensive actions, such as strikes and raids, against terrorists and their infrastructure. By law, the CT mission is assigned to designated special operations forces that are organized and trained to combat terrorism.

Counterterrorism is offensive measures taken to prevent, deter, and respond to terrorism.

JP 1-02

Those forces conduct counterterrorism outside the territory of the United States. Relevant National Security Decision Directives, National Security Directives, contingency plans, and other relevant classified documents address sensitive and compartmentalized CT programs. Commanders who employ conventional forces to strike against organized terrorist forces operating in their areas of operations conduct a conventional offensive operation, not counterterrorism.

ANTITERRORISM

5-52. To meet the terrorist threat, an integrated and comprehensive AT program must be developed and implemented at every echelon of command. The program fosters a protective posture in peacetime (such as units performing normal duties and serving in security

Antiterrorism is defensive measures used to reduce the vulnerability of individuals and property to terrorist acts, to include limited response and containment by local military forces.

JP 1-02

assistance organizations, peacekeeping missions, or mobile training teams) that will carry over to a wartime environment. Antiterrorist measures identify and reduce the risk of loss or damage of potential targets and develop procedures to detect and deter planned terrorist actions before they take place, thereby reducing the probability of a terrorist event. The measures also encompass the reactive or tactical stage of an incident, including direct contact with terrorists to end the incident with minimum loss of life and property.

5-53. The AT program stresses deterring terrorist incidents through preventive measures. JP 3-07.2 details the AT program and its implementation including the terrorist threat, legal considerations, intelligence and counterintelligence, executing crisis management, and preventive measures. Antiterrorism is a component of force protection. FM 3-07.2 has more information on integrating antiterrorism into a force protection program.

5-54. Terrorists know the importance of their act's emotional impact on an audience other than the victim. News media coverage works for terrorists who want to incite public fear while pursuing their objectives. Another determinant of tactics and target selection is the role the terrorist group perceives itself as playing. Terrorism can also be used as either an overt or a covert aspect of a political movement engaged in a power struggle within an

existing political system. (Chapter 3 discusses counterinsurgency; this chapter discusses insurgency.)

5-55. Terrorist tactics vary in sophistication according to the level of training the group has received. Tactics may include assassination, arson, bombing, hostage taking, hijacking or skyjacking, kidnapping, seizure, raids or attacks on facilities, sabotage, hoaxes, intimidation, and the use of weapons of mass destruction.

5-56. A terrorist incident may have several objectives. Some of the more common include attracting publicity for the group's cause, demonstrating the group's power, showing the existing government's lack of power, extracting revenge, obtaining logistic support, and causing a government to overreact.

5-57. Terrorist groups are categorized by government affiliation to help security planners anticipate terrorist targets and their sophistication of intelligence and weaponry. Three general categories of terrorist groups exist:

- Nonstate supported is a terrorist group that operates autonomously, receiving no significant support from any government. The Aum Shin-rikyo, the group responsible for the 1995 nerve gas attack on several Tokyo subway trains, demonstrates this group.
- State supported is a terrorist group that generally operates independently but receives support from one or more governments. The Popular Front for the Liberation of Palestine, which receives support from certain Middle-Eastern states, illustrates this group.
- State directed is a terrorist group that operates as an agent of a government, receiving substantial intelligence, logistic, and operational support from the sponsoring government. An example is the Abu Nidal organization, which a North-African state directs to some degree.

NONCOMBATANT EVACUATION OPERATIONS

5-58. Noncombatant evacuation operations (NEOs) are conducted to support the DOS in evacuating noncombatants and nonessential military personnel from a foreign nation to an appropriate safe haven or the United States. These operations evacuate US citizens whose lives are endangered by war, civil unrest, or natural disaster. Such operations also may include evacuating selected citizens of the host nation or third-country nationals. NEOs usually involve a swift insertion of a force, temporary occupation of an objective, and planned withdrawal upon completion of the mission. (JP 3-07.5 contains tactics, techniques, and procedures for conducting NEOs.)

5-59. During a NEO, the chief of mission (COM), not the senior military commander, has the ultimate responsibility for successfully completing the NEO and safeguarding the evacuees. While the welfare of in-country US personnel is the paramount consideration, a decision to evacuate an embassy and the order to execute a NEO also impacts political elements that may influence the timing of an evacuation. US foreign policy objectives are the determining factor in the timing of an evacuation.

5-60. Uncertainty characterizes NEOs. They may be directed without warning because of sudden changes in a country's government or its relationship with the United States, or because of a sudden threat to US citizens from a

force within or external to a HN. There is only one type of NEO. However, a NEO may occur in any of the three operational environments: permissive, uncertain, or hostile. Situations can rapidly change from permissive to uncertain or hostile with little warning; alternative plans should be developed for each.

Operation URGENT FURY

In October of 1983, anti-US Marxists overthrew Grenada's leader, Maurice Bishop. This posed an immediate threat to the nearly 600 American students and 400 other foreigners living in Grenada. Memories of the Iranian hostage crisis were fresh. Anxious to avoid a similar experience, policymakers mounted URGENT FURY in haste. The DOS requested DOD assistance in evacuating noncombatants off the island. But DOS evacuation planning quickly shifted to DOD planning for a much larger military operation. Early in the morning of October 25, 1983, Operation URGENT FURY began with assaults on Grenada's airstrips at Point Salinas and Pearls. US Army Rangers rescued the medical students, who were subsequently evacuated by military aircraft to Charleston Air Force Base, South Carolina.

5-61. In most NEOs, the United States does not actively engage militarily against the forces posing a threat to the noncombatants. Therefore, the situation may limit military action. In some instances, constraints on introducing military personnel into a country that occur before the evacuation operation hampers planning and preparation. The DOS and embassy personnel coordinate with the evacuation force regarding details, such as political constraints, legal issues, agreements, rights, privileges, and immunities (if any) within the host nation, the intermediate staging base, and the safe haven.

5-62. The COM prepares an embassy Emergency Action Plan (EAP). The appropriate combatant commander reviews the plan to ensure that the EAP is accurate and adequate to allow support by military operations. Normally, the EAP directs the use of scheduled airlines, chartered flights, or surface transportation. EAPs include the following information:

- Evacuation sites.
- Anticipated number of evacuees.
- Assembly areas and major supply routes.
- Command posts.
- Key personnel.
- Description of the embassy communication system, transportation fleet, and warden system.
- Quantity of Class I supplies on hand at the embassy.
- Standard map products of the local area with annotations identifying critical landmarks.

5-63. An Army element, another service department, or a joint task force may conduct a NEO. Figure 5-2 shows the organization of the evacuation force. As early as possible in the planning, the evacuation commander forms the advance party and requests permission to send it to the site of the operation.

The advance party may consist of two elements: the forward command element and the evacuation site party. The forward command element coordinates with in-country DOS personnel and host-nation authorities and establishes communication links among the higher headquarters and DOS. The evacuation site party conducts reconnaissance to evaluate, validate, and confirm assembly areas and evacuation sites. The evacuation commander with the COM, or his designated representative, determines the size and composition of the forward command element and evacuation site party.

5-64. The size and composition of the evacuation force depends on the number of evacuees, evacuation sites, assembly areas, and the tactical situation. The evacuation force assists the COM in protecting and evacuating the evacuees. This duty may include providing security and other support in caring for the evacuees as requested. Shelter, safety, interpreters, local immigration, embassy, support liaison, and medical personnel should be present during processing. As the advance party rejoins the main body, the evacuation force may consist of the command group, marshalling element, security element, logistic element, and communications element.

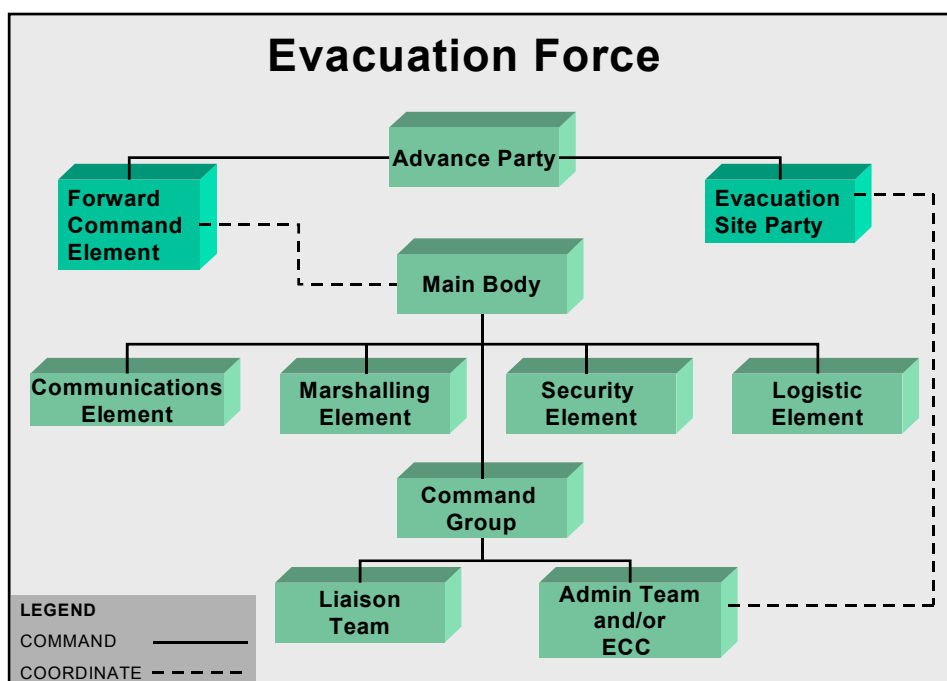

Figure 5-2. Organization of the Evacuation Force

5-65. The evacuation control center (ECC) conducts evacuee processing. The ECC supports the DOS, which conducts processing, screening, and selected logistic functions associated with emergency evacuation of noncombatants. The three guiding principles for any ECC are accuracy (everyone is accounted for), security, and speed (processing is accomplished quickly and efficiently). The evacuation force staff should keep abreast of changes in the total number of potential evacuees by receiving periodic updates from the embassy staff.

5-66. Evacuees move to safe havens as quickly as possible. Coordination for using facilities, customs requirements, security, transportation, medical support, and billeting is required. A limited security force can provide necessary internal and perimeter security and can consist of command groups, reception teams, processing teams, comfort teams, scheduling teams, military pay and allowance teams, and security teams.

5-67. Repatriation, when American citizens and their families are officially processed back into the continental US, is the final step in the evacuation process. At that point, evacuees may require various services to ensure their well being and onward movement to either their safe haven location or designated location. The Department of Health and Human Services (DHHS) has total national responsibility for the repatriation of all US noncombatant evacuees in a declared national emergency or on referral by Department of State. Under DHHS plans, DOD is responsible for the repatriation of DOD noncombatants and DHHS is responsible for the repatriation of all non-DOD repatriates. DOD Directive 3025.14 designates the secretary of the Army as the DOD Executive Agent for repatriation plans and operations concerning the return of DOD noncombatant evacuees. The deputy chief of staff for personnel has been designated as the secretary's action agent.

ARMS CONTROL

5-68. The overarching goal of arms control is to prevent or deter war; promote stability; reduce the potential damage of a conflict; and reduce defense expenditure. *Arms control* is a concept that connotes—

- Any plan, arrangement, or process, resting on explicit or implicit international agreement, governing any aspect of the following: the numbers, types, and performance characteristics of weapons systems (including the command and control, logistics support arrangements, and any intelligence-gathering mechanism); and the numerical strength, organization, equipment, deployment, or employment of the armed forces retained by the parties (it encompasses disarmament).
- On some occasions, those measures are taken for the purpose of reducing instability in the military environment (JP 1-02).

5-69. Arms control operations sometimes support diplomatic missions. When conducting arms control operations related to diplomatic initiatives, Army forces work closely with the DOS. Mission analysis determines the lead agency. Arms control conducted in support of an Army operation prevents the escalation of conflict or prevents or minimizes the effects of potential conflict.

5-70. The executive agent for arms control within the US government is the Department of State. It administers the confidence- and security-building measures, including the arms control and disarmament programs that were formerly under the Arms Control and Disarmament Agency before merging with the Department of State.

5-71. Also, various interagency organizations negotiate and verify international arms control and disarmament agreements. Participants usually include the DOS, DOD, Joint Chiefs of Staff, Department of Energy, and others. The intelligence community supports and advises them in formulating and verifying policy. Army personnel often participate in these organizations

by providing knowledge of weapon systems to ensure their destruction or other proper disposition, including secure movement and storage. Examples of the various interagency organizations include—

- A deputies committee that advises the National Security Council on arms control.
- US delegations to arms control negotiations.
- An on-site inspection agency that observes the execution of the treaty to determine compliance.
- Working groups that coordinate the US position for treaty negotiations.
- US geographic combatant commanders with their own verification responsibilities that complement those of the interagency groups.

5-72. Arms control may be a distinct mission or part of another operation. During peace operations, arms control may aid in implementing or verifying a treaty. During humanitarian assistance operations, it may help secure the environment for the delivery of aid. Among other tasks, Army personnel and forces conducting arms control may—

- Supervise or facilitate the implementation of a treaty or agreement.
- Enforce restrictions on weapons.
- Establish areas of limited armaments.
- Inspect weapons production facilities, demilitarized zones, storage sites, and belligerent forces and facilities.
- Seize weapons of mass destruction (nuclear, biological, chemical, or conventional) and other arms.
- Disarm belligerent forces.
- Secure confiscated weapons.
- Escort and transport sensitive items.
- Dismantle, destroy, or dispose of designated weapons and hazardous material.

SHOW OF FORCE

5-73. A *show of force* is an operation designed to demonstrate US resolve that involves increased visibility of US deployed forces in an attempt to defuse a specific situation that, if allowed to continue, may be detrimental to US interests or national objectives (JP 1-02). The US conducts shows of force for three principal reasons: bolster and reassure allies, deter potential aggressors, and gain or increase influence. Army units are not usually assigned the mission to conduct a show of force; rather they usually conduct other operations such as those listed below, for the purpose of showing force. Shows of force are normally executed as—

- A permanent forward deployment of military forces.
- Multinational training exercises.
- The introduction or buildup of military forces in a region or area.
- An increase in the readiness status and level of activity of designated forces.

Operation DESERT THUNDER

In the fall and winter of 1997, Saddam Hussein engaged in a series of aggressive acts that threatened regional stability. He violated no-fly zones, threatened to shoot down U2 reconnaissance over-flights, and interfered with United Nations weapons inspection teams. The ensuing operation was named Operation DESERT THUNDER. Beginning in February 1998, General Anthony C. Zinni, the combatant commander of the US Central Command, increased the number of bombers, strike aircraft, and Tomahawk land attack missiles deployed in Southwest Asia. At the same time, he deployed a potent ground force. The rapid deployment of more than 7,000 soldiers and Marines into the theater gave to the commander of the JTF-KU the combat power and support forces necessary to deter Saddam Hussein's aggression. It also provided assurance to US allies in the Gulf that Kuwait would be defended as necessary. The mere presence of forces does not show resolve or deter aggression. The presence of powerful, capable forces has that desired effect. Effective shows of force demonstrate credible, capable, and sustainable responses.

5-74. Although actual combat is not the goal, shows of force can rapidly and unexpectedly escalate. Forces employed as a show of force assume that combat is probable and organize appropriately. All actions ordinarily associated with the projection of a force to conduct combat operations pertain to show of force deployment.

5-75. Political concerns dominate shows of force to an extraordinary degree. Army forces must conduct these operations within delicate legal and political constraints. All elements of the force must define and clearly understand the mission and rules of engagement. Often the actions of a single soldier can have operational- or strategic-level consequences.

5-76. Commanders may also conduct a show of force as part of other stability operations, such as peace operations. In peace operations, a show of force may be in the form of a patrol or other operation designed to establish a presence in a particular area. Such a presence has the effect of preempting or deterring aggressive acts by hostile factions, reassuring the local populace that they are safe and secure, and gaining or sustaining influence and legitimacy.

Chapter 6

Support Operations

In support operations, Army forces provide essential services, assets, or specialized resources to help civil authorities deal with situations beyond their capabilities. Support operations usually involve actions that help civil authorities or nongovernmental organizations (NGOs) provide required support directly to the affected population. Army forces may provide relief or assistance directly when necessary; however, they normally support the overall effort controlled by another agency. When visualizing a support operation, commanders recognize that they will have to use a different definition of the enemy. In support operations, the adversary is often disease, hunger, or the consequences of disaster. The types of support operations are domestic support operations (DSO) and foreign humanitarian assistance (FHA) operations. They share four forms: relief operations; support to chemical, biological, radiological, nuclear, and high-yield explosive (CBRNE) consequence management; support to civil law enforcement; and community assistance. The forms occur to varying degrees in both DSO and FHA operations. Since domestic emergencies can require Army forces to respond with multiple capabilities and services, forms may be conducted simultaneously during a given operation.

DOMESTIC SUPPORT OPERATIONS

6-1. DSO supplement the efforts and resources of state and local governments and NGOs in the United States (US). During DSO, the US military always responds in support of another civilian agency. The Department of Defense (DOD) may also provide assistance to communities with programs that improve the community, its infrastructure, and its ability to serve the local population. DSO require extensive coordination and liaison among interagency, joint, multijurisdictional (state and local), and active and reserve component entities. In all DSO, federal military forces remain under the federal military chain of command.

6-2. Army forces provide domestic support primarily in accordance with DOD Directive (DODD) 3025.15. The military assistance to civil authorities

CONTENTS

Domestic Support Operations	6-1	Relief Operations	6-9
Domestic Emergencies	6-2	Support to Domestic CBRNE	
Roles and Responsibilities	6-2	Consequence Management	6-12
Federal Response Plan	6-5	Support to Civil Law Enforcement	6-19
Foreign Humanitarian Assistance	6-8	Community Assistance	6-25
Forms of Support Operations	6-9		

directive is wide ranging, addresses responses to both natural and man-made disasters, and includes military assistance to civil disturbances, counterdrug activities, combatting terrorism, and law enforcement. See Figure 6-1.

DOMESTIC EMERGENCIES

6-3. *Domestic emergencies* affect the public welfare and occur in the 50 states, District of Columbia, Commonwealth of Puerto Rico, or US possessions and territories. These emergencies are a result of enemy attack, insurrection, civil disturbance, earthquake, fire, flood, or public disasters or equivalent emergencies that endanger life and property or disrupt the usual process of government (JP 1-02). The term domestic emergency includes any or all of the following emergency conditions:

- A civil defense emergency.
- Civil disturbances.
- A major disaster.
- A natural disaster.

6-4. A *civil defense emergency* is a domestic emergency disaster situation resulting from devastation created by an enemy attack and requiring emergency operations during and following that attack. It may be proclaimed by an appropriate authority in anticipation of an attack (JP 1-02).

6-5. *Civil disturbances* are riots, acts of violence, insurrections, unlawful obstructions or assemblages, or other disorders prejudicial to public law and order. The term civil disturbance includes all domestic conditions requiring or likely to require the use of Federal Armed Forces pursuant to the provisions of Chapter 15 of Title 10, United States Code (JP 1-02).

6-6. A *major disaster* is any flood, fire, hurricane, tornado, earthquake, or other catastrophe that, in the determination of the president, is or threatens to be of sufficient severity and magnitude to warrant disaster assistance by the federal government under Public Law 606, 91st Congress (42 United States Code 58) to supplement the efforts and available resources of State and local governments in alleviating the damage, hardship, or suffering caused thereby (JP 1-02).

6-7. A *natural disaster* includes all domestic emergencies except those created as a result of enemy attack or civil disturbance (JP 1-02).

ROLES AND RESPONSIBILITIES

6-8. The secretary of defense retains approval authority for support to civil authorities involving use of combatant commander-assigned forces, personnel, units, and equipment; DOD support to civil disturbances; and DOD responses to acts of terrorism. Approval can also involve DOD support that will result in a planned event with the potential for confrontation with specific individuals and groups or will result in using lethal force.

6-9. The secretary of the Army, as executive agent for the secretary of defense, is the approval authority for emergency support in response to natural and man-made disasters (except CBRNE response). Military forces respond to direction and guidance from the secretary of the Army's action agent, the Director of Military Support (DOMS). When the combatant commander

assets are not involved, the secretary of the Army may task the services or DOD agencies to provide emergency support.

ACTIVITY	Relief Operations		Support to CBRNE Consequence Management	Support to Civilian Law Enforcement Agencies				Community Assistance
	Disaster Relief	Humanitarian Relief		Counterterrorism	Counterdrug	Civil Disturbance	General Support	
Reconnaissance	X	X	X		X			
C2 Systems Support	X	X	X	X	X			
Intelligence Support		X	X	X	X	X		
Planning Support	X	X	X	X	X			
Manpower Support	X	X	X	X	X		X	
Training Support			X	X	X		X	
Supply & Equipment	X	X	X	X	X		X	
Transportation	X	X	X	X	X	X		
Food Preparation	X	X	X					
Water Purification	X	X	X					
Mortuary Affairs	X	X	X					
Laundry/Shower	X	X	X					
Temporary Shelter	X	X	X					X
Health Support	X	X	X					X
NBC			X					
Power Generation	X	X	X					
General Engineering	X	X	X		X			X
Security	X	X	X			X		
Restore Law and Order	X	X	X			X		
EOD Support			X					X
Search and Rescue	X	X	X					X
Traffic Control	X	X	X					X
Fire Fighting	X		X					X
Provide Liaison	X	X	X	X	X	X	X	X

Figure 6-1. Forms of Support Operations and Some of Their Associated Activities

6-10. The DOMS serves as the secretary of the Army's action agent for plans and coordinates the DOD domestic support mission to civilian authorities. He is a general officer appointed by the secretary of the Army. The DOMS is the DOD primary contact for all federal departments and agencies during DOD involvement in most domestic support operations. However, DSO responsibilities in dealing with combatting terrorism are divided between the Joint Staff and the DOMS. The Joint Staff handles crisis management response assistance, while the DOMS provides consequence management response support. (See the discussions of Crisis Management and Consequence Management later in this chapter.) The Joint Staff also supports counterdrug operations.

6-11. Each state governor appoints a state coordinating officer (SCO) to oversee disaster operations for the state. The SCO is the primary point of contact for the federal coordinating officer (FCO) in facilitating disaster assistance.

6-12. The FCO is appointed by the director of the Federal Emergency Management Agency (FEMA) for the president. The FCO coordinates the timely delivery of federal disaster assistance to the affected state, local governments, and disaster victims. He works closely with the SCO to determine state requirements and to coordinate national-level issues. This includes coordinating with the catastrophic disaster response group and the national-level centralized coordinating group of representatives from the federal departments and agencies under the Federal Response Plan (FRP). Operating from a forward-deployed disaster field office co-located with or close to the state operations center, the FCO must laterally coordinate and support between Emergency Support Function participants, as well as integrate the support of agencies not part of the FRP.

6-13. The defense coordinating officer (DCO) is the DOD representative designated to coordinate on-the-scene activities with the FCO. FEMA and other federal agency requests for support from DOD go through the DCO for validation and resourcing from appropriate military organizations.

6-14. The Army National Guard (ARNG), in *state* status, is the governor's primary response organization for emergencies and disasters. The state National Guard (NG) responds under the governor's control, not DOD's, and in accordance with state laws. However, if the NG is *federalized* by order of the president, it responds under the same limitations and command and control (C2) arrangements as active component military organizations. NG commanders must plan and train their forces for both federal and state missions.

6-15. The state area command (STARC) of the NG develops disaster emergency plans with other state and local agencies. The STARC and the DCO establish necessary liaison to coordinate and effectively manage local, state, and federal activities. The STARC can assist federal forces with contracting support as well as logistic support from NG resources not otherwise committed. Within the state or territory, the NG coordinator for military assistance is the plans, operations, and military support officer, responsible to coordinate military assistance to civil authority programs.

6-16. The US Army Reserve is capable of extensive domestic support operations. This assistance and support may include the use of equipment and other resources, including units and individuals. US Army Reserve personnel

may be activated in a volunteer status when ordered to active duty in lieu of annual training or after the president has declared a national emergency. Use of reserve component persons and units is restricted, under law, to immediate response under provisions of DODD 3025.1 and to population and resource control for CBRNE incidents. US Army Reserve units may be used to respond to a CBRNE incident if they are in the area and in annual training status. They may not be used for other types of emergencies.

6-17. Civil affairs (CA) [forces] may be especially useful to a commander during DSO due to their training in assessment, liaison, and civil-military coordination. Commanders should consider requesting CA assets at the earliest opportunity.

FEDERAL RESPONSE PLAN

6-18. When the president declares a major disaster, federal agencies are directed to provide disaster assistance to support state and local authorities. For command and control purposes, FEMA is designated the lead federal agency (LFA) responsible for coordinating federal emergency preparedness, planning, management, and disaster assistance functions. FEMA carries out these responsibilities by implementing the FRP, which they are also tasked with developing and maintaining.

6-19. The FRP establishes a process and structure for the systematic, coordinated, and effective delivery of federal assistance to address the consequences of any major disaster or emergency declared under the Stafford Act (Title 42, USC, sections 5142–5203). The FRP facilitates delivery of all types of federal assistance to state and local governments by organizing federal agencies and the American Red Cross under emergency support functions (ESFs). The FRP identifies 12 ESFs and assigns responsibilities of the primary and support agencies for each. DOD has a primary role in ESF 3, Public Works and Engineering (DOD and Army Corps of Engineers) and a supporting role in the others (see Figure 6-2).

	Emergency Support Function	Lead Federal Agency
1	Transportation	Department of Transportation
2	Communications	National Communications System
3	Public Works and Engineering	Department of Defense
4	Fire Fighting	Department of Agriculture
5	Information and Planning	Federal Emergency Management Agency
6	Mass Care	Agency for International Development
7	Resource Support	Government Services Administration
8	Health and Medical Services	Department of Health And Human Services
9	Urban Search and Rescue	Federal Emergency Management Agency
10	Hazardous Materials	Environmental Protection Agency
11	Food	Department of Agriculture
12	Energy	Department of Energy

Figure 6-2. The Emergency Support Functions and Their Lead Federal Agencies

6-20. The FRP recognizes that DOD maintains significant resources that may be available to support the federal response to a major disaster or emergency. FEMA may request DOD support when executing the FRP.

Planning Considerations for DSO

6-21. When directed, Army forces respond to domestic emergencies in accordance with the FRP and combatant command supporting plans as tasked by the Joint Strategic Capabilities Plan.

6-22. The DOMS receives emergency support requests dealing with civil disturbances, natural or man-made disasters, and their consequences and then transmits them to the appropriate combatant commands, military departments, or DOD agencies. A commander's mission analysis determines the appropriate force to employ. Considerations include the nature and magnitude of the emergency and the anticipated scope of support.

Legal Considerations

6-23. Army involvement in DSO involves many legal issues. DSO plans require comprehensive legal review. Commanders involved in DSO should staff plans, policies, programs, exercises, funding, operations, constraints, and limitations with their staff judge advocates to ensure conformity with legal requirements. Under the Constitution, civilian governments must preserve public order and carry out government operations in its territorial limits. The Constitution allows using the military to execute or enforce the law when necessary to protect federal or civilian property and functions. However, significant restrictions exist on employing federal military forces domestically. (See Appendix B.)

6-24. Military intelligence assets may not specifically target US citizens during DSO. However, military departments should share with federal, state, or local civilian law enforcement officials any information collected during the normal course of military operations that may be relevant to a violation of any federal or state law. This does not permit the planning or creation of missions or training for the primary purpose of aiding civilian law enforcement officials. It also does not permit conducting training or missions for routinely collecting information about US citizens. During disaster assistance operations, intelligence personnel and assets may be used for liaison and other support activities. Intelligence capabilities may, with authority from DOD—

- Acquire information about threats to the physical security of DOD personnel, installations, operations, or official visitors or for force protection.
- Analyze and disseminate information to disaster relief personnel and disaster field offices.
- Support disaster field officer operations using intelligence estimate procedures and skills.

6-25. US law prohibits psychological operations units from targeting US citizens. However, units can use these assets to help disseminate critical information to the civilian population. Information may include safety and health messages, location of water or food distribution points, and designations of restricted areas and temporary shelters.

6-26. DSO may take place simultaneously with other operations. However, unless directed by the president, primary military missions take precedence over DSO. Consequently, there may be competing requirements for units and support—such as transportation, equipment, and supplies—that have to be balanced with commitments elsewhere in the world. Sourcing conflicts must therefore be resolved quickly to prevent delays in responding to time-sensitive requirements.

Posse Comitatus Act

6-27. The Posse Comitatus Act (Title 18 USC, section 1385) forbids federal military forces from giving law enforcement assistance to civil authorities. However, Constitutional and statutory exceptions to this prohibition do exist. The recent emphasis on drug interdiction has led to an increase in those exceptions.

Whoever, except in cases and under circumstance expressly authorized by the Constitution or act of Congress, willfully uses any part of the Army or the Air Force as a posse comitatus or otherwise to execute the laws shall be fined not more than \$10,000 or imprisoned not more than two years, or both.

Title 18 USC, Section 1385

6-28. The Judiciary Act of 1798 allowed United States marshals to call on the military as a *posse comitatus* (a body of persons called upon by law enforcement personnel to help preserve the peace, make arrests, and serve writs). This law continued in effect until after the Civil War, when the federal government used Army forces to execute Reconstruction policies in the states of the former Confederacy. The southern states regarded this practice as abusive and repressive, and in 1878, President Rutherford B. Hayes signed the original bill ending the practice.

6-29. The Posse Comitatus Act prescribes criminal penalties for use of the US Army or Air Force to execute the laws of or to perform civilian law enforcement functions within the US. DOD policy extends this prohibition to the US Navy and Marine Corps. Prohibiting the military from executing the laws means that military personnel may not participate directly—

- In arrest, search and seizure, stop and frisk, or interdiction of vessels, aircraft, or vehicles.
- In surveillance or pursuit.
- As informants, undercover agents, or investigators in civilian legal cases or in any other civilian law enforcement activity.

6-30. The Posse Comitatus Act does not apply to—

- Members of the NG when not in federal service.
- Members of the reserve components when not on active duty or active duty for training.
- A soldier when off duty and acting only in a private capacity.
- Soldiers taking action for the primary purpose of furthering a military or foreign affairs function of the US, for example, enforcing military justice, maintaining law and order on military installations, or protecting classified materials.

Insurrection Act

6-31. Under the Insurrection Act, (Title 10 USC, Chapter 15), federal forces may be used to restore law and order during civil disturbances. Because the use of federal forces to quell civil disturbances is expressly authorized by statute, the proscriptions of the Posse Comitatus Act do not apply. The Insurrection Act permits the commitment of US forces by the president under three circumstances:

- To support a state request. The federal government has a Constitutional obligation to protect every state in the union, upon request, from domestic violence. Federal forces were used to quell the Los Angeles riots in 1994.
- To enforce federal authority. The president has the authority to commit the US military to enforce federal law. The provisions of this statute were used to enforce public school desegregation in Arkansas and Alabama in the early 1960s.
- To protect Constitutional rights. Citizens of the US are guaranteed equal protection under the law. The president is authorized to use the US military, during times of insurrection, to protect citizens in states that cannot protect the Constitutional rights of its citizens. President Kennedy sent soldiers to Alabama in 1963 to protect the rights of civil rights protesters.

Use of Force Guidelines and Rules of Engagement

6-32. With the exception of support to counterdrug operations, the standing rules of engagement for US forces, as delineated in Chairman of the Joint Chiefs of Staff Instruction (CJCSI) 3121.01A, do not apply to forces in domestic support operations. DOD civil disturbance plans contain use-of-force guidance for forces in civil disturbance situations. US forces deployed to assist federal and local authorities in disaster assistance missions, such as hurricanes and earthquakes, follow use-of-force guidelines as set forth in the mission’s execute order and subsequent orders.

FOREIGN HUMANITARIAN ASSISTANCE

6-33. In foreign humanitarian assistance operations, Army forces supplement or complement the efforts of host-nation civil authorities or agencies that have the primary responsibility for providing assistance. FHA is limited in scope and duration and focuses exclusively on prompt aid to resolve an immediate crisis. Longer-term activities designed to support full recovery to predisaster conditions will normally become part of a combatant commander’s theater engagement plan and transition to a stability operation. DODD 5100.46 establishes policy guidance for FHA operations.

Foreign humanitarian assistance operations are conducted to relieve or reduce the results of natural or man-made disasters or other endemic conditions such as human suffering, disease, or privation that might present a serious threat to life or that can result in great damage to or loss of property.

JP 3-07.6

6-34. Army forces normally participate in FHA operations as part of a joint task force, with the US country team of the affected country. They provide support in accordance with appropriate treaties, memorandums of agreement, and memorandums of understanding and US fiscal authority and foreign policy. The US Agency for International Development has LFA responsibility for coordinating FHA for strictly internal humanitarian disasters. The Department of State's Bureau of Population, Refugees, and Migration has the lead when an emergency primarily involves refugees. Army forces usually conduct FHA operations to support host-nation civil authorities with other civilian agencies.

FORMS OF SUPPORT OPERATIONS

6-35. The forms of support operations are relief operations, support to CBRNE consequence management, support to civil law enforcement, and community assistance. These forms may occur in both foreign and domestic operations. However, in FHA Army forces most often conduct relief operations, and in some cases, support incidents involving CBRNE and community assistance. These forms differentiate between the types of Army response, command and control, and resources provided to civil authorities and populations. However, Army forces involved in support operations execute overlapping activities. For example, a CBRNE incident may cause mass effects requiring support in the form of relief operations and support to civil law enforcement. (See Figure 6-1.)

RELIEF OPERATIONS

6-36. Relief operations respond to and mitigate the effects of natural or man-made disasters (including CBRNE incidents). They maintain or restore essential services and activities to mitigate damage, loss, hardship, or suffering. Relief is primarily a state, local, or host-nation responsibility. To support



the efforts of local authorities or the lead agency, the president can employ Army forces before, during, or after an event to save lives; protect property, public health, and safety; or lessen or avert the threat of catastrophe.

6-37. Actions that Army forces execute during relief operations in DSO mirror those during FHA operations. Relief focuses on the well-being of supported populations or recovery of critical infrastructure after a natural or man-made disaster. In disaster situations, Army forces provide

predominantly combat support and combat service support units. Figure 6-3 lists critical relief functions.

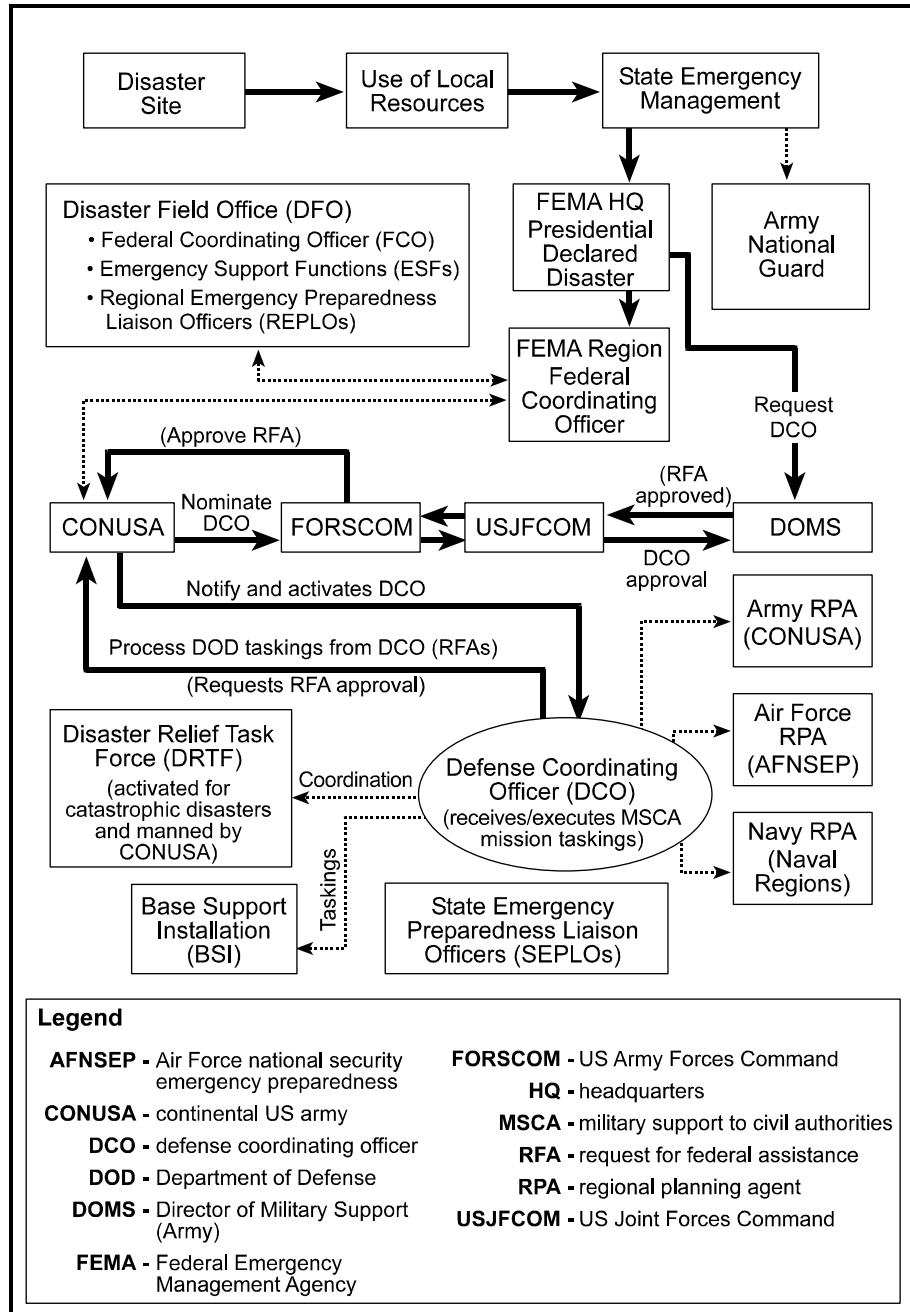

Figure 6-3. Domestic Relief Operations in Disaster Relief

6-38. Domestically, relief operations include domestic emergencies and can be conducted in response to environmental hazards. Hazards include animal and plant diseases, oil and hazardous material spills, wildfires, nuclear weapons and their radiological components, mass immigration emergencies,

and mail service augmentation during a postal work stoppages or natural disaster. Foreign relief operations typically include constructing basic sanitation facilities and shelter as well as providing food and medical care. They may also include activities that support dislocated civilians, such as camp organization, basic construction, administration, protection, and movement or relocation to other countries, camps, and locations.

6-39. In response to an emergency, relief focuses on lifesaving measures to alleviate the immediate needs of a population in crisis. It often includes providing medical support, food, water, medicines, clothing, blankets, and shelter. In some cases, it involves transportation support to move affected people from a disaster area. Relief operations also restore minimal infrastructure and create the conditions needed for longer-term recovery. This includes establishing and maintaining the minimum safe working conditions needed to protect relief workers and the affected population. Relief may involve repairing or demolishing damaged structures; restoring or building bridges, roads, and airfields; and removing debris from critical supply routes and relief sites.

6-40. Commanders may provide immediate response to domestic and foreign disaster situations under provisions of DODD 3025.1. This immediate assistance does not take precedence over ongoing combat and support missions. Any commander or DOD official acting under immediate response authority should quickly advise the DOMS through command channels and seek approval or additional authorization as needed from the respective chain of command.

6-41. Immediate response is situation-specific and may or may not be associated with a declared disaster. Commanders may use immediate response authority to assist in the rescue, evacuation, and emergency medical treatment of casualties; the maintenance or restoration of emergency medical capabilities; and the safeguarding of public health. Commanders may assist with the emergency restoration of essential public services and utilities. This may

Immediate response is that action authorized to be taken by a military commander or by responsible officials of other DOD agencies to provide support to civil authorities to prevent human suffering, save lives, or mitigate great property damage.

JP 3-07.7

include fire fighting, water, communications, transportation, power, and fuel. They may also provide immediate assistance to public officials in emergency clearance of debris, rubble, and explosive ordnance from public facilities and other areas to permit rescue or movement of people and restoration of essential services. This list is not exhaustive. However, commanders should recognize that this is not a blanket provision to provide assistance and that the ultimate aim is to transition relief functions to civilian organizations.

6-42. Although immediate assistance is given with the understanding that costs will be reimbursed, such assistance should not be delayed or denied when the requester is unable or unwilling to make a commitment to reimburse. Support under the provision of immediate response is generally limited to 72 hours or less. Longer duration may transition the operation

from response to recovery, which is not the intent of the provisions of DODD 3025.1.

6-43. Disaster relief operations normally include the stages *response*, *recovery*, and *restoration*. The military role is often most intense in the response stage, decreasing steadily as the operation moves into the recovery and restoration stages. Response operations focus on those life-sustaining functions required by the population in the disaster area. Recovery operations begin the process of returning the community infrastructure and services—both municipal and commercial—to a status that satisfies the needs of the population. Restoration is a long-term process that returns the community to pre-disaster normalcy. Military forces normally redeploy as operations transition from the response to the recovery stage.

6-44. DOD evaluates requests for employment of DOD resources according to six criteria: legality, lethality, risk, cost, readiness, and appropriateness. Commanders ensure that Army resources are used judiciously in relief operations by adhering to the following principles:

- Civil resources are applied first in meeting civil authorities' terms.
- Army forces provide resources only when response or recovery requirements exceed the capabilities of civil authorities as determined by FEMA or another LFA.
- Specialized capabilities (airlift and reconnaissance) must be used judiciously because demand may be greater than availability.
- Army forces remain under military command and control at all times. Authority is exercised through the DOD executive agent.
- Army forces may perform immediate response to assist civil authorities or the public when the president has not declared a major disaster or emergency. The local commander must determine that imminently serious conditions exist and that prompt action is required to save lives, prevent human suffering, or mitigate property damage.
- Unless otherwise directed by the secretary of defense, military missions have priority over military assistance to civil authorities.

SUPPORT TO DOMESTIC CBRNE CONSEQUENCE MANAGEMENT

6-45. Other US government agencies have primary responsibility for responding to domestic CBRNE incidents due to terrorists or other causes. Local authorities will be the first to respond to a CBRNE incident. However, Army forces have a key supporting role and can quickly respond when authorized. In a permissive overseas environment, the president may make Army assets available to assist a foreign government after a CBRNE incident. Such assistance may be linked to concurrent relief operations.

CBRNE incidents are deliberate or unintentional events involving a chemical, biological, radiological, nuclear, and high-yield explosive, that produce catastrophic loss of life or property.

FM 3-0

6-46. CBRNE incidents require specialized resources. Mass casualties from these incidents require decontamination and massive medical response. A CBRNE incident can create public health threats related to food, vectors,

water, wastewater, solid waste, and mental health. Figure 6-4 lists activities that support relationships for CBRNE consequence management support.

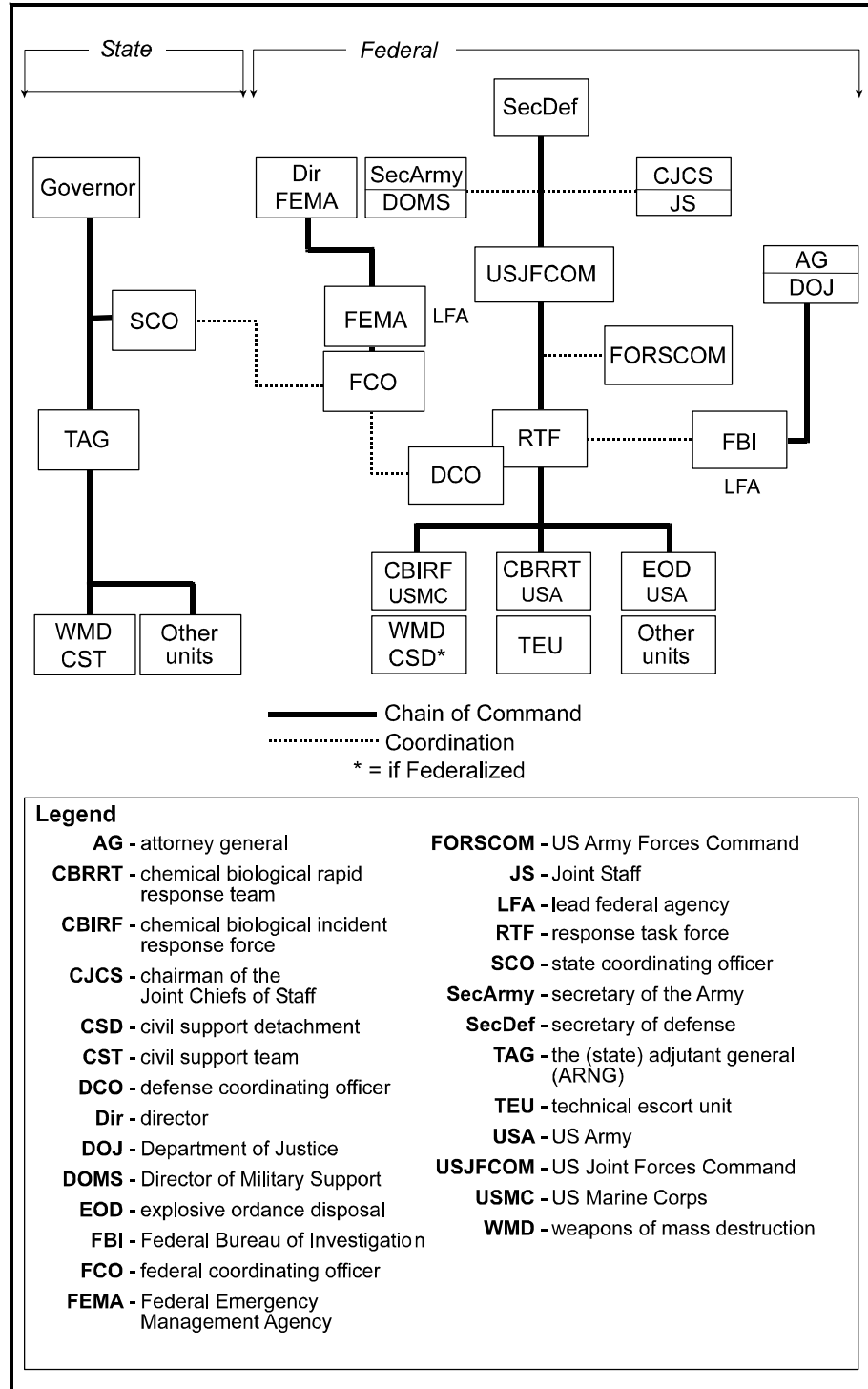

Figure 6-4. CBRNE Consequence Management

6-47. The Defense Against Weapons of Mass Destruction Act of 1996 mandates enhancing domestic preparedness and response capability for terrorist attacks involving nuclear, radiological, biological, and chemical weapons. In addition, Presidential Decision Directive (PDD) 39 and PDD 62 direct measures to prevent and manage the consequences of terrorist use of CBRNE.

6-48. Army forces assist civil authorities in protecting US territory, population, and infrastructure before an attack by protecting critical efforts and supporting domestic preparedness. When directed, Army forces can deploy in response to a CBRNE incident and deal with its consequences. A large explosion also is considered a CBRNE incident because the civil authorities have yet to determine its cause, and the resulting damaged site may contain a radiological, biological, or chemical agent.

6-49. Responding to terrorism involves instruments that provide crisis management and consequence management. Based on the situation, a federal crisis management response may be supported by federal consequence management and technical operations, which may operate concurrently.

Crisis Management

6-50. When a credible terrorist threat to use a CBRNE device exists, crisis management procedures apply. The federal government exercises primary authority to prevent, preempt, and terminate threats or acts of terrorism and to apprehend and prosecute the perpetrators. State and local governments provide assistance as required. The LFA for response to acts of terrorism is the Federal Bureau of Investigation (FBI). Crisis management involves measures to resolve the situation, investigate, and prepare a criminal case for prosecution under federal law. Involved US government agencies support the FBI until the attorney general transfers the role of the LFA to FEMA.

Crisis management includes measures to resolve a hostile situation and to investigate and to prepare a criminal case for prosecution under federal law.

JP 3-07.7

Consequence Management

6-51. Consequence management begins after an actual CBRNE release or detonation. State and local governments exercise primary authority to respond to the consequences of a terrorist incident. The federal government provides assistance as required. Consequence management is generally a multifunctional response coordinated by emergency management agencies. FEMA has primary responsibility for coordinating federal assistance to state and local governments.

Consequence management is actions which comprise those essential services and activities required to manage and mitigate problems resulting from disasters and catastrophes, including natural, man-made, and terrorist incidents.

JP 3-07.7

Technical Operations

6-52. Technical operations are activated to address aspects of nuclear, biological, and chemical materials when encountered in crisis and consequence management operations. Technical operations may be before the operation to support the crisis management response and continue to support the consequence management response. The LFA for technical operations depends on the material involved and the location of the incident. The *Handbook of DOD Assets and Capabilities for Response to a Nuclear, Biological, or Chemical Incident* details the federal support to technical operations, to include DOD response capabilities.

Technical operations include actions to identify, assess, dismantle, transfer, dispose of, or decontaminate personnel and property exposed to explosive ordnance or weapons of mass destruction.

Federal Response Plan

Command and Control Process

6-53. All disasters are local. The local communities have the first responders. These local responders are the first to help victims of a CBRNE incident. First responders include fire, police, emergency medical services, and hazardous materials units. In most cases the local fire chief, police chief, or other local official will be the on-scene commander. (JP 3-07.7 contains tactics, techniques, and procedures for support to a domestic CBRNE incident.)

6-54. The NG weapons of mass destruction civil support teams (WMD-CST) are the first military responders. The WMD-CST deploy to an incident site to assess a suspected CBRNE event in support of an on-scene commander (such as fire chief or police chief). These teams advise civilian responders regarding appropriate action. They also facilitate requests for assistance from civil authorities and help expedite the arrival of additional state and federal assets. Each team has a mobile analytical laboratory for field analysis of chemical or biological agents and a command suite that can provide communications interoperability among the various responders. The WMD-CST are designed for domestic consequence management and will normally be quickly deployed as a state asset along with other NG units without DOD authorization. If federalized, these teams may be deployed as an element of a response task force in support of the LFA. (See Figure 6-3 for command relationships in domestic CBRNE incidents.)

6-55. FEMA coordinates the activities of federal, state, and local agencies at the national level with its emergency support team and in the affected area with its emergency response team. FEMA also ensures that state response plans and capabilities are adequate and tested.

6-56. The commander of a combatant command US Joint Forces Command serves as the DOD principal planning agent and supported commander for consequence management in the continental United States (CONUS). He also validates all requests for military assistance to consequence management in his area of responsibility. US Joint Forces Command resources and trains Joint Task Force–Civil Support (JTF-CS) to provide the initial CBRNE incident response and serve as the DOD C2 headquarters in CONUS.

6-57. The JTF-CS is a standing joint task force (JTF) under US Joint Forces Command. The commander of JTF-CS is responsible for providing military assistance to civil authorities for consequence management of CBRNE incidents within the US, its territories, and its possessions. The JTF-CS is a standing JTF headquarters trained for a flexible response, tailored to the type of CBRNE, and support requested by the LFA. When employed, it provides DOD C2 and has operational control (OPCON) of all DOD assets (less special operations forces) in support of the LFA. The JTF-CS initially focuses its efforts on incident assessment and rapid deployment of DOD capabilities to ensure efficient and synchronized support to LFA efforts. As forces arrive on the scene, the focus shifts to fulfilling requests for assistance from the LFA and the on-scene commander. Personnel from the active component, Army Reserves, NG, government civilians, and contractors make up the JTF-CS.

6-58. Subordinate to the JTF-CS are response task forces (RTFs), also C2 elements. These forces are regional: RTF-East (1st Army) and RTF-West (5th Army). The RTF commander assumes OPCON of all committed DOD elements (less special operations forces) and coordinates military support of crisis and consequence management. The initial response element establishes liaison with the supported civil agencies and coordinates support for the follow-on personnel. The RTF establishes a command post near the incident and exchanges liaison officers with appropriate civil agencies and military commands. US Joint Forces Command also has other deployable assets for crisis management responses to CBRNE threats or incidents.

Protection of Critical Assets

6-59. Hostile forces may attack facilities essential to society, the government, and the military. These assaults can disrupt civilian commerce, government operations, and military capabilities. Critical assets include telecommunications, electric power, public health services and facilities, gas and oil, banking and finance, transportation, water, emergency services, and government continuity. In conjunction with civil law enforcement, Army forces may protect these assets or temporarily restore lost capability.

6-60. DODD 5160.64 provides DOD policy and responsibilities for protecting DOD and non-DOD critical assets worldwide. In peacetime, responsibility for protecting non-DOD critical assets rests primarily with the civil sector owners and with local, state, and federal law enforcement authorities. Responsibility for protecting non-US critical assets rests with the appropriate national authority. However, the Army and other DOD agencies must be prepared to assist in their protection during emergencies that seriously damage or threaten DOD operations.

Military Support to Foreign Consequence Management

6-61. DOD support to foreign consequence management operations focuses on providing specialized assistance in response to CBRNE incidents involving US military forces and installations, or vital interests. US military forces may also respond to a request for assistance by a foreign government. CJCSI 3214.01 contains guidance for planning and coordinating DOD support to foreign consequence management operations. In accordance with the instruction, each geographic combatant commander develops plans for,

identifies exercise forces for, and, when directed, responds to foreign CBRNE incidents from their areas of responsibility.

6-62. Primary responsibility for managing and mitigating the effects of a foreign CBRNE incident resides with the host nation. The Department of State is the LFA for foreign consequence management operations. All DOD support will be coordinated through the responsible chief of mission and country team.

6-63. Army support for foreign consequence management operations is provided on presidential approval, either when requested by the host nation (HN) or as part of an international relief effort. In both situations, all Army assets stay under the command of the geographic combatant commander.

6-64. The military can provide a sequential response to foreign consequence management operations:

- Initial DOD response. When authorized by the president, each geographic combatant commander provides initial DOD response. The response may be limited to deploying a headquarters element conduct a situation assessment and evaluation. This headquarters element forms the nucleus for subsequent DOD support and may assume C2 of DOD assets committed to help resolve a particular incident.
- Subsequent DOD response. The level and type of subsequent DOD assistance is determined by the type, severity, and location of the incident as well as the host-nation capabilities and requests for assistance. Depending on presidential guidance, the affected geographic combatant commander provides assets to the incident site for immediate assistance.
- Follow-on assistance. When directed by the president, the US Joint Forces Command deploys specialized CONUS-based assets to augment the affected geographic combatant commander's organic committed resources.

Consequence Management Support Functions

6-65. Support functions performed during consequence management operations are just as important as they are in other military operations. A CBRNE event can have a catastrophic effect on the ability of a community to provide for itself. US military forces and other DOD agencies are organized with personnel and equipment to support themselves while performing specific functions. Army units need additional combat service support to provide substantial assistance to the populace and local community. Examples of vital support functions provided by Army forces are communications, transportation, engineering, maintenance, medical, and public affairs.

6-66. Fast, reliable, and accurate communications are essential for crisis management. Army units come equipped with organic communication systems that can be used to establish connectivity with the many nonmilitary agencies involved in the incident. Securing adequate internal communications at the incident site, as well as establishing external communications to higher echelons is critical. Commanders should look for government-furnished telecommunications, commercially leased communications, and existing available telecommunications. Communication officers should

address the issue of frequency management early, as a large number of emergency responders may be sharing the same frequencies. Mutual support, connectivity, and minimum interference among agencies are vital.

6-67. Transportation is an essential logistic function. Forces must deploy from home station to the incident site and provide mobility once there. Army units may have to use their internal assets to support the on-scene commander if other sources of transportation are not available. Army equipment is suited for negotiating the rubble and debris often associated with consequence management. Required transportation support will likely include ground and air, both fixed-wing and rotary. Helicopters can be used for reconnaissance, and for aeromedical evacuation. Pilots must use care when operating helicopters near a contaminated area as rotor wash tends to spread the contamination.

6-68. Public works and engineering support include technical advice and evaluations, engineering services, construction management and inspection, emergency contracting, emergency repair of wastewater and solid waste facilities, and real estate support. Other engineering requirements are—

- Heavy equipment for camp construction and power-generation.
- Emergency clearance of debris for reconnaissance and passage of emergency personnel.
- Temporary construction or repair of emergency access routes.
- Emergency restoration of critical public services and facilities.
- Technical assistance and damage assessment.
- Emergency demolition.
- An effective maintenance program to ensure required support is provided.
- Consideration of all classes of supply.
- Maintenance of safe food and water. Unless canned or otherwise protected, all food should be thoroughly inspected. Designated medical authorities must approve all water and food supplies before consumed.
- Military transportation units for bulk supply distribution.
- Laundry facilities for both contaminated and noncontaminated clothes.
- Mortuary affairs.

6-69. Nuclear, biological, and chemical (NBC) weapons can cause large numbers of military and civilian casualties, and widespread destruction and disruption that will challenge medical capabilities and resources. Rigorous and disciplined adherence to public health standards can limit and mitigate the effects of NBC incidents. Medical treatment facilities should have protective shelters to enable them to operate in contaminated environments. Specific medical responses include triage, trauma, and preventive medicine. Patients requiring emergency medical treatment before decontamination are treated in the decontamination area. Military medical assets can provide limited neuropsychiatric triage and stabilization of clinical cases to reduce the disabling effects associated with the posttraumatic stress disorder. Stress management can also reduce hysteria surrounding the incident. Medics must be prepared to perform casualty decontamination near the incident site, prior to evacuation, or to establish decontamination and detection stations at local

hospitals. In a terrorist incident, many ambulatory casualties will self-evacuate, arriving at the medical treatment facility or hospital still contaminated.

6-70. Disseminating information to the world's public is a media event. The relationship developed between the military and the media will be critical to the success of the operations as well as the story being accurately told. Public affairs (PA) activities during the initial incident have immediate public impact. A proactive, comprehensive PA program must be conducted to expedite the flow of information to the public and internal audiences. There should be a single story, coordinated with all federal agencies involved.

6-71. Unless specifically authorized by the president, the military does not conduct law enforcement activities. But Army units can conduct patrols to look for disaster victims, to help in assessment, and to assist in communications. The presence of soldiers may deter looters and other violators. Moreover, soldiers can provide a labor force capable of performing whatever duties may be required.

SUPPORT TO CIVIL LAW ENFORCEMENT

6-72. It is DOD policy to cooperate with civilian law enforcement officials to the extent practical. However, cooperation must consistently meet the requirements of applicable law, the needs of national security and military preparedness, and the historic tradition of limiting direct military involvement in civilian law enforcement activities. US military forces are never placed under the command of civilian law enforcement officers or nonfederalized NG commanders. DODD 5525.5 contains the policy providing military support, including personnel and equipment to LEAs.

Support to Civil Law Enforcement

- Counterterrorism
- Counterdrug
- Civil disturbances
- General support

6-73. When compelling and extraordinary circumstances exist outside the territorial jurisdiction of the US, the secretary of defense may approve direct assistance by military personnel to execute the laws.

6-74. The Army assists civil law enforcement by providing personnel, equipment, training, and expert advice within the limits of applicable law. ARNG units in state status (Title 32 USC) provide the primary source of military assistance to state and local LEAs. They may assist civil authorities in instances when federal units are precluded due to the restrictions of the Posse Comitatus Act.

Support to Counterterrorism

6-75. Only the president (or a presidential decision directive) may authorize employing US military forces in response to acts or threats of domestic terrorism. The secretary of defense must also approve all requests for assistance in responding to acts or threats of domestic terrorism. (See Chapter 5 discussion of Combatting Terrorism.)

6-76. Army forces do not conduct domestic counterterrorism operations; however, they may provide support to LFAs during crisis management and

consequence management of a terrorist incident. Army forces may provide specialized or technical capabilities to assist in defusing or resolving crises. Support includes opening lines of communication for military assistance, evacuating casualties, reconnaissance, and decontaminating or assessing CBRNE events.

Support to Counterdrug Operations

6-77. The DOD principal counterdrug (CD) mission is the detection and monitoring of the aerial and maritime transit of illegal drugs into the US. Title 10 USC, Chapter 18 gives basic guidance for interaction among active component forces, reserve component forces, and civilian law enforcement agencies. Title 10 prohibits the military from directly participating in arrests, searches, seizures, or other similar activity unless authorized by law. The FY 1989 and subsequent National Defense Authorization Acts have authorized the DOD to provide more support to LEAs in the CD effort.

6-78. The Army significantly contributes to counterdrug support of federal, state, and local LEAs. The Army provides operational support, linguist support, reconnaissance, maintenance, intelligence analysis, engineer support, equipment, facilities, and training and planning support to LEAs in the United States. Soldiers also provide counterdrug support to foreign nations through the supported unified commanders. Host nations and LEAs worldwide receive various means and methods of support. (See Chapter 5 for support to counterdrug operations and JP 3-07.4.)

6-79. **Training.** Training support provided to LEAs includes basic military skills such as basic marksmanship, patrolling, mission planning, medical, and survival. DOD policy states that no US LEA personnel will receive advanced military training. "Advanced military training" consists of advanced marksmanship (including sniper training), urban operations, advanced urban operations, close quarters battle or close quarters combat, and similar specialized training. As an exception to this policy, the US Army Military Police School is authorized to train LEA personnel in the Counterdrug Special Reaction Team Course, the Counterdrug Field Tactical Police Operations Course, and the Counterdrug Marksman and Observer Course. Additionally, on an exceptional basis, the commander in chief, US Special Operations Command may approve such training by special operations forces.

6-80. JTF-6, US Army Training and Doctrine Command (TRADOC), and the ARNG provide resources for domestic counterdrug training. JTF-6 provides oversight to military mobile training teams in support of LEAs in CONUS. TRADOC and the US Army Military Police School provide resident counterdrug training for LEAs. The ARNG sponsors several counterdrug schools that train law enforcement officers in enforcement-level counterdrug skills. In addition, the National Interagency Civil-Military Institute (NICI) is a federally funded DOD field operating activity of the National Guard Bureau operated by the California National Guard. The NICI programs teach how to plan and coordinate multijurisdictional and interagency counterdrug and support operations and programs that use military resources. The institute includes a research and analysis division that maintains an extensive library on joint counterdrug operations and general drug policy. This information is available for official use.

6-81. **Use of Technology.** The Army Counterdrug Research, Development, and Acquisition Office makes military research, development, and acquisition available to LEAs. This office informs agencies of new technical capabilities that may apply to law enforcement. It can also assist them in contracting and procuring technical equipment. A program that resembles the surplus equipment programs for civil defense and rural fire districts provides excess military equipment to LEAs for counterdrug use. The secretary of defense has established four regional support offices to support this program.

6-82. **Requests for Support.** Law enforcement agencies may request support through several channels. These channels are either the state NG counterdrug coordinator, the appropriate Continental United States Army (CONUSA), the US Army Forces Command (FORSCOM) counterdrug support cell, the National Guard Bureau counterdrug task force, or the DOD coordinator for drug enforcement policy and support. The preferred method for requesting support is through the state NG counterdrug coordinator. If the NG cannot provide support, the request will be passed to the appropriate CONUSA. Requests for CONUS counterdrug support, not related to NG support activities, may be forwarded through Operation Alliance to JTF-6, Fort Bliss, Texas. Requests for residence CONUS counterdrug training may be forwarded directly to the US Army Military Police School.

6-83. **Provision of Support.** Within the US, the NG is the primary source of military support to federal, state, and local LEAs. The US Army Reserve and active duty units also support LEAs. Army support to counterdrug operations is another aspect of the Army's traditional role of providing military support to civil authorities. ARNG forces execute these missions under control of their state governor, while US Army Reserve and active duty units operate under the control of a JTF, such as JTF-6 in the southwest US, or in support of a CONUSA.

6-84. Each state or territory has a NG counterdrug coordinator who receives LEA requests for support and coordinates the execution of support as directed by the state adjutant general (or commanding general). The ARNG conducts counterdrug operations in accordance with state laws and applicable NG regulations.

Civil Disturbance Operations

6-85. Civil disturbances may range from unruly demonstrations to widespread rioting with looting and arson. In extreme cases, civil disturbances may include criminal acts of terrorism and violence. Civil disturbances in any form are prejudicial to public law and order. The Army has a role in assisting civil authorities to restore law and order when local and state law enforcement agencies are unable to quell civil disturbances.

Civil disturbances are group acts of violence and disorders prejudicial to public law and order.

JP 1-02

6-86. Under provisions of the Constitution and selected federal statutes, the president may order federal armed forces to aid local and state civil authorities to protect the Constitutional rights of citizens. DODD 3025.12 contains

guidance concerning the use of military assets in civil disturbances. The president may direct federal intervention in civil disturbances to—

- Respond to state requests for aid in restoring order.
- Enforce the laws of the United States.
- Protect the civil rights of citizens.
- Protect federal property and functions.

6-87. Conduct of Civil Disturbance Operations. The Army helps civil authorities restore law and order when state and local law enforcement agencies cannot control civil disturbances. Under the provisions of the Constitution and selected federal statutes, the president may order federal armed forces to aid local and state civil authorities to protect the Constitutional rights of citizens. Federal military forces may also protect federal facilities and installations in any state, territory, or possession. The DOD Civil Disturbance Plan (GARDEN PLOT) provides direction for Army forces directed to quell civil disturbances. FM 3-19.15 provides guidance in—

- Preparing for and providing assistance to civil authorities in civil disturbance control operations.
- Planning and training for such operations.
- The operational tasks and techniques employed to control civil disturbances and neutralize special threats.

6-88. The JTF commander exercises control of all federal military forces—including NG in federal status—committed to assist civil authorities. Federal military forces remain under the military chain of command during civil disturbance operations. Federal forces will not be placed under the command of civil officials or NG commanders in nonfederal status. Civilian authorities retain control of their state and local LEAs. The JTF commander establishes liaison with the senior civilian representative of the attorney general (SCRAG) and other appropriate federal, state, and local civil authorities.

6-89. Federal military forces must be tailored to the specific civil disturbance situation. Combat support and combat service support units will be required to sustain the force throughout employment. Coordination with civil authorities may allow the force to draw on resources available from state and local agencies. Close and continuous coordination between the federal military forces and the LEAs provide commanders with the detailed information required to employ and protect the force effectively.

6-90. In supporting civil disturbance operations, intelligence personnel may conduct close and continuous liaison with LEAs and the military police. This liaison ensures that the units receive needed information to allow the commander to adequately protect the force. He should staff intelligence support missions with his senior intelligence officer and legal counsel before approving them.

6-91. Federal military forces may perform tasks or missions appropriate to their organization and training; they must not be employed in ways that violate legal restrictions in effect. Military forces may disperse unlawful assemblies and patrol disturbed areas to prevent unlawful acts. They may assist in distributing essential goods and maintaining essential services. Forces may also establish traffic control points, cordon off areas, release smoke and

obscurants, and serve as security or quick-reaction forces. Certain types of missions are always inappropriate for military forces during civil disturbance operations. Military forces should never gather intelligence on civilians; interdict a vehicle; arrest or stop and frisk civilians; or act as informants, under cover agents, investigators, or interrogators.

6-92. Requests for execution of specific military missions are typically passed through one state or federal law enforcement coordinating officer, as approved by the SCRAG. Validated requests are transmitted to the JTF commander for staffing and coordination. Approved missions are assigned through the military chain of command to the appropriate element or unit for execution. Units and soldiers will not accept taskings or missions directly from law enforcement or civilian officials, except when placed in a direct support relationship as approved and ordered through the military chain of command.

6-93. Military liaison should be provided to each LEA headquarters generating requests for support. This liaison can assist LEA officials in determining the types and quantities of military support to request. The JTF headquarters can facilitate this mission assignment process by providing LEAs with a detailed listing of the types of missions military forces may conduct.

6-94. A deployed unit's area of operations should coincide with the jurisdiction or subdivision boundaries of the LEA it supports. This arrangement facilitates liaison and coordination between law enforcement agencies and military chains of command.

6-95. Committing military forces to civil disturbance control operations does not automatically give these forces police power. The police power of military forces is intentionally bound by legal constraints. Whenever possible, civil police apprehend, process, and detain civil-law violators. Military forces only perform these functions when necessity dictates and to the minimum extent required. These functions are returned to civil authorities as soon as possible. When military forces have achieved enough order to allow the local authorities to resume control, the military's mission is accomplished and its active role in controlling the disturbance ends.

6-96. Army commanders must know what options they have available. They must be able to be flexible and selective in their responses. A commander selects the option that best responds to a given civil disturbance in that specific physical and psychological environment. The commander strives to reduce the intensity of the confrontation and to restore order.

6-97. As the disturbance subsides, the commander gradually reduces the number and scope of operations and begins removing his equipment from the area. However, withdrawal is not immediate. That could lead to a resurgence of the disturbance.

6-98. **Roles.** The NG, as a state organization, responds to the governor in accordance with state law for civil disturbance operations. NG regulations direct planning and training for the civil disturbance mission. During most civil disturbance situations, the NG will be the first military responder and will usually remain in state active duty status throughout the operation. The

president may federalize the NG for civil disturbance operations at the state governor's request.

6-99. Federal Army forces help civil authorities restore law and order when the magnitude of the disturbance exceeds the capabilities of local and state law enforcement agencies, including the NG. Federal military forces may also protect federal facilities and installations in any state, territory, or possession. The DOD Civil Disturbance Plan provides direction for Army forces in civil disturbances.

6-100. GARDEN PLOT provides guidance and direction for participation by all DOD components in civil disturbance operations in support of civil authorities. GARDEN PLOT applies to the military departments, the unified and specified commands, DOD agencies, and other DOD components for planning, coordinating, and executing military operations during domestic civil disturbances.

The Los Angeles Riots

On 29 April 1992, the worst civil unrest since the riots of the 1960's erupted in the streets of Los Angeles. Forty-four people died and hundreds were injured before order was restored. Property damage reached the billion-dollar mark because of rampaging looters and the thousands of fires that they set. It began as a small disturbance in south central Los Angeles, but quickly escalated, spreading rapidly through the city and county. The violence initially overwhelmed law enforcement authorities, resulting in the burning of large areas of the city. California's governor committed the state police and 2,000 National Guard soldiers to assist in restoring law and order in the early morning hours of 30 April. A National Guard military police company arrived in the area that afternoon and immediately began operations to support local police.

Joint Task Force-Los Angeles (JTF-LA) was formed following a presidential executive order on 1 May. It federalized units of the California NG (CAARNG) and authorized active military forces to assist in restoring law and order. JTF-LA formed and deployed within 24 hours, assembled from US Army and Marine forces. It operated in a unique domestic disturbance environment while working with city, county, state, and federal agencies and the CAARNG.

JTF-LA successfully met the three objectives defined in its mission statement. "JTF-LA assumes command and control of federalized National Guard, active duty Marine and Army forces, establishes liaison with local law enforcement agencies, and conducts civil disturbance operations to restore order in the greater Los Angeles area."

6-101. **Requests for Military Assistance.** Requests for military assistance normally originate with a state and are forwarded to the president. The attorney general must coordinate and manage all requests for federal military assistance for civil disturbance operations. He then advises the president whether and when to commit federal military forces.

6-102. The attorney general, as the head of the LFA responsible for law enforcement, will appoint a SCRAG. The SCRAG must coordinate federal

civil disturbance operations and assist the state civil authorities. The SCRAG has the authority to request military assistance for civil disturbance support from federal military forces. Civilian officials remain in charge of civil disturbance operations.

6-103. The secretary of the Army is the DOD executive agent for federal military operations in response to civil disturbances. Within the department of the Army, the DOMS coordinates the functions of all military services. The DOMS, on behalf of the joint staff, publishes an execute order designating a combatant command as the supported command for the civil disturbance operations. This order also designates the supporting combatant commands, services, and agencies.

6-104. The supported combatant command will determine the organization and forces required to accomplish the civil disturbance mission. The combatant command may establish a joint task force to make best use of the forces available for the mission.

General Support

6-105. Title 10 USC, Chapter 18, sections 371-382 and other federal laws allow for additional limited military support to law enforcement agencies. The military may share information and provide equipment, facilities, and other services (see DODD 5525.5). The Army may provide training to federal, state, and local civilian law enforcement officials. Such assistance may include training in operating and maintaining equipment. This ordinarily does not include large-scale or elaborate training nor regular or direct involvement of military personnel in activities that are fundamentally civilian law enforcement operations. Training of federal, state, and local civilian law enforcement officials is provided under the following guidance:

- This assistance is limited to situations when using non-DOD personnel would be infeasible or impractical from a cost or time perspective and would not otherwise compromise national security or military preparedness concerns.
- Such assistance may not involve DOD personnel in a direct role in a law enforcement operation, except as otherwise authorized by law.
- Except as otherwise authorized by law, DOD personnel locate and perform such assistance where confrontation is unlikely.
- Military departments and defense agencies may provide expert advice to federal, state, or local law enforcement officials in accordance with Title 10 USC, Chapter 18, section 373.
- When loans of equipment facilities or personnel to law enforcement are made, such loans are approved at a level no lower than general officer. In addition, the secretary of defense must approve requests for potentially lethal support.

COMMUNITY ASSISTANCE

6-106. Community assistance applies the skills, capabilities, and resources of the Army to the needs and interests of America and local communities. Supporting and participating in events and activities that benefit Army forces and the civilian community build on a long tradition of the Army helping

American communities. Community assistance can have a large impact because active component, ARNG, and US Army Reserve units are located in thousands of towns and cities across the nation. What a command does, or fails to do, for the community will affect the attitudes of the American people, on whom the Army depends for its support and existence. Every commander should identify opportunities to conduct initiatives that meet specific needs; have specific start points and end states; enhance readiness; and advance the interests of the nation, the Army, and local communities.

Fundamentals

6-107. Community assistance projects and operations must enhance the Army's image, have a positive impact on the unit or individual soldier, and contribute to the common good of the nation and local communities. Army commanders must ensure that their initiatives do not compete with local resources or services, do not benefit any particular interest group, and will not result in any monetary or service remuneration. Army commanders located outside of CONUS may find these principles useful in fostering their established relationships with adjoining host-nation commanders. However, they must consider applicable combatant command guidelines and host-nation laws and agreements before implementing community assistance programs.

6-108. **Command Emphasis.** Commanders should take an active interest in their relationships with civilian officials, encouraging appropriate community assistance programs. Establishing long-term, harmonious, productive relationships with national, state, and community officials can significantly benefit both the Army and civilian communities.

6-109. **Individual and Unit Enhancement.** Community assistance activities increase public awareness and understanding of the Army, inspire patriotism, and enhance the Army's reputation as a good neighbor. They positively influence public opinion toward the Army while also enhancing the combat readiness of the organization. They help build unit morale. Community assistance activities are an excellent opportunity for soldiers to serve as role models, which not only enhances recruiting, but also motivates other soldiers. These activities promote their self-esteem and further their sense of service to the nation.

6-110. **Readiness Enhancement.** Community assistance activities should enhance individual and unit combat readiness. They should make the best use of assets and foster a positive training environment where soldiers can become involved in realistic, hands-on training opportunities. Whenever possible, community assistance projects should exercise individual soldier skills, encourage teamwork, challenge leader planning and coordination skills, and result in measurable, positive accomplishments. Finally, they should enable a unit to use its equipment, providing training opportunities that increase operator proficiency.

6-111. **Community Benefit.** Community assistance activities should contribute to the health and welfare of the nation and local communities, making the Army an integral partner in progress and development. These activities enhance the ability of the nation and communities to provide the best

possible services to the citizenry. They promote a positive, healthy, safe environment as well as an understanding of the basic principles, values, and ideals on which America is built. This results in increased awareness of America's history and the Army's role in a continuously changing world.

6-112. **Common Interest and Benefit.** Because the Army belongs to the American people, it should support only events and activities of common interest and benefit. Commanders should avoid providing assistance and support to one sponsor that they cannot also provide to other sponsors. Army assistance should not selectively benefit any person, group, or corporation—whether profit or nonprofit, religious or sectarian, ideological, fraternal, political, or commercial.

6-113. **Noncompetitive.** Army community assistance projects should not compete with resources and services commercially available in the community. Commanders must not authorize assistance activities when local businesses can provide the same or similar assistance and support.

6-114. **Nonprofit.** Army support for or participation in community assistance activities cannot be provided if based on a monetary-profit. Commanders must ensure that no Army person or unit realizes a monetary profit, a gratuity, or remuneration in any form not provided for by public law or regulation.

Types

6-115. Community assistance activities can be national efforts focused on developing public support for the Army and its national contribution. They can also be state or local community efforts focused on improving the community, its infrastructure, and its ability to serve the local population. Both types improve the lives of American citizens, foster the values and purposes of democracy, and give the American people hope and confidence in a changing world.

6-116. **National Efforts.** National efforts should develop an open, cooperative relationship between the Army and the American people. National efforts take advantage of the technical, vocational, and group skills of military professionals to enhance the lives of American people. They supplement programs available in the civilian sector and through other government agencies, not replace them. They provide opportunities for the Army to contribute to the growth and welfare of the nation, improving its perception of the Army, its capabilities, and its personnel. Army and DOD regulations provide detailed guidance on national effort programs. Examples of national efforts include Public Works Maintenance and Management, exercised through the US Army Corps of Engineers, and assistance programs, such as the Civilian Community Corps and Drug Demand Reduction Programs.

6-117. **State and Local Efforts.** The guiding principle behind state and local efforts is that the installation and the community have a common interest in providing the best possible support to each other. A cooperative relationship exists because soldiers stationed at the installation receive life support from the community while many of the civilians who make up the community receive life support from the installation. The interdependence of the military installation and the civilian community can involve economics, education, health care, basic services, and quality-of-life issues.

6-118. The goal of local commanders should be to develop an open, mutually satisfactory, cooperative relationship between the installation and the community. Good state and local efforts improve the community's perception of the Army; the installation; and the soldiers, family members, and civilians who are part of the installation.

6-119. Commanders should consider appointing a committee or small agency to act as a clearinghouse for community assistance requests. The garrison commander or the director of plans, training, and mobilization might head this committee. It should include the public affairs officer, the staff judge advocate, the chaplain, command surgeon, and representatives from the directorate of resource management, the directorate of installation support, and the directorate of personnel and community activities. Units that play a major role in the activity should be represented. Key community leaders should also be invited to serve on this committee.

6-120. **Community Cooperation.** Many community activities and efforts can be established in a more formalized manner. These efforts permit both the installation and local community to expand and enhance their services to their respective communities. Examples of these efforts are explained in the following paragraphs.

6-121. Memorandums of agreement or understanding permit the installation or organization to enter into an agreement with the local community. They can provide critical services not available in the community, augment community services unable to meet demand, or ensure that emergency services are available in the shortest possible time. Examples include arrangements to provide air ambulance support, search and rescue, fire fighting capability, explosive ordnance disposal, emergency or broad-based medical care, wildlife and domestic animal management, assistance in safety and traffic control, emergency snow removal, and temporary supplemental housing for the displaced or disadvantaged.

6-122. Speakers effectively develop an understanding of the Army and stimulate patriotic spirit. They inform the public about installation activities, its units, and its soldiers. Commanders should establish an installation speakers bureau and encourage soldiers of all ranks to participate in the program.

6-123. Maintaining liaison through informal community councils can enhance open communications with community officials and organizations. Councils have various responsibilities, such as developing and promoting new ways for members of the command to participate actively in local community activities and resolving potential and actual areas of conflict. Commanders may present public service awards to private citizens, local community leaders, citizen groups, and organizations for their support of the Army. Commands can further community liaison through membership in civic, business, and professional organizations when the goals and objectives of those organizations benefit the Army and their programs and projects are consistent with Army interests.

6-124. Participating in public events and memorials is an excellent way to accomplish community relations objectives. These representatives of the Army serve as ambassadors to the civilian community and promote patriotism, interest in the Army, and awareness of the professionalism of US forces.

6-125. Exhibits and displays of Army equipment, historical materials, models, devices, and other information can enhance understanding of the Army and the installation. They can also promote patriotism and educate the public. They provide an excellent opportunity for our soldiers to interact with members of the local community while communicating the professionalism, readiness, and standards of our forces.

6-126. Community service physical improvements focus on ensuring that the physical infrastructure is as safe as possible and provides the fullest possible range of support to the population. These activities encompass a wide range of programs that do not compete with the services provided by contractors and businesses in the local civilian community. Examples include—

- Construction projects that enhance the recreational, educational, environmental, or cultural facilities of the community, such as building community picnic areas and hiking and biking trails.
- Projects that create or enhance a safe, clean environment, such as removing debris from a community wildlife area or painting a community recreation center.
- Demolition projects that enhance the safety and appearance of the community, such as the removal of unstable playground equipment.

6-127. Community service social improvements, which focus on making the social environment as healthy as possible, provide the widest range of support to the population. They encompass a myriad of projects, including—

- Support to youth programs, such as Scouting, and programs that assist special need audiences, such as the Special Olympics.
- Involvement in ventures and projects that enhance the educational or cultural climate of the community, such as adult literacy, school reading, or community theater programs.
- Participation in special events, such as law enforcement or fire prevention awareness programs that enhance the welfare of the community.

6-128. Commanders should consider the contributions that all organizations and personnel associated with their installation could make in community assistance activities. For example, Army Reserve Officer Training Corps (ROTC) cadets may be a valuable resource for participating in or supervising selected community assistance projects. ROTC cadets, particularly those in the final two years of training, can gain valuable leadership experience by participating in community activities. Communities will benefit from the dedication of intelligent, reliable, and energetic future Army leaders in their community efforts.

6-129. Another example of soldiers who contribute to community assistance activities is Army recruiters dispersed throughout the United States. These noncommissioned officers serve as positive role models and leaders who may be called on to assist in DOD-approved community activities as recruiting duties permit.

Appendix A

Interagency Coordination

US Armed Forces as a whole must be multi-mission capable; interoperable among all elements of US Services and selected foreign militaries; and able to coordinate operations with other agencies of government and some civil institutions.

National Military Strategy of the United States of America, 1997

Success in operations can depend on the ability to blend and engage all elements of national power effectively. Interagency coordination forges the vital link between the military instrument of power and the economic, political or diplomatic, and informational entities of the United States (US) government (USG) as well as nongovernmental agencies. Stability operations and support operations span a broad range of activities with many organizations typically involved. Therefore, to have an overview of the various organizations with which Army forces are involved during these actions is vital. The interagency coordination process should bring together the interests of multiple agencies, departments, and organizations to achieve unity of effort toward a common goal. FM 3-16 and JP 3-08 contain additional information.

NATIONAL LEVEL

A-1. The National Security Council (NSC) advises and assists the president in integrating all aspects of the national security policy—domestic, foreign, military, intelligence, and economic (in conjunction with the National Economic Council). The NSC system is the principal forum for consideration of national security issues requiring presidential decisions. The NSC system provides the foundation for interagency coordination in developing and implementing national security policy. It is the only level of the executive branch in which authoritative direction to the various departments can be given. The functions, membership, and responsibilities of the NSC are set forth in Presidential Decision Directive (PDD) 2.

CONTENTS	
National Level	A-0
Domestic Relief Operations	A-1
Federal Response Plan	A-1
State and Local Authorities	A-2
Foreign Operations.....	A-3
Theater Orientation.....	A-4
Department of Defense	A-4
Department of State.....	A-5
Central Intelligence Agency.....	A-9
US Agency for International Development	A-9
Nongovernmental Organizations	A-10
Regional and International Organizations	A-12
Civil-Military Operations Center	A-15
Liaison	A-17

A-2. The members of the NSC include the president, the vice president, the secretary of state, and the secretary of defense. The Central Intelligence Agency (CIA) director regularly attends meetings as a cabinet-level officer. The Chairman of the Joint Chiefs of Staff (CJCS) is a statutory advisor and also attends meetings of the NSC. Other regular attendees include the secretary of treasury, the assistant to the president for National Security Affairs (referred to as the National Security Advisor), the assistant to the president for economic policy, and the chief of staff to the president. Heads of executive departments and agencies and other senior officials, such as the US permanent representative to the United Nations (UN), may be invited to attend meetings of the NSC on an ad hoc basis. The NSC staff tracks and directs the development and implementation of national security policies for the president.

DOMESTIC RELIEF OPERATIONS

A-3. Department of Defense (DOD) often provides disaster assistance to support civil authorities responding to domestic emergencies. DOD policy concerning domestic relief operations is contained in DOD Directive (DODD) 3025.1. The following discussion relates to the conduct of disaster assistance.

FEDERAL RESPONSE PLAN

A-4. The Federal Response Plan (FRP) guides crisis response to disasters in the US. Federal departments and agencies support the operations of the FRP by executing their assigned functional responsibilities. The Robert T. Stafford Disaster Relief and Emergency Assistance Act (Appendix B) provides statutory authority for USG domestic disaster assistance.

A-5. The FRP applies to natural disasters. These may include earthquakes, forest fires, hurricanes, typhoons, tornadoes, floods, and volcanic eruptions; technological emergencies involving radiological or hazardous material releases; and other federal emergencies identified under the act.

A-6. Following a request for assistance from the governor of the affected state or territory and the determination that local ability to respond has been exceeded, the president implements the FRP by declaring a domestic disaster. With this presidential declaration, the resources of the federal government can be focused on restoring normalcy.

A-7. While the secretary of defense retains the authority to approve the use of combatant command resources for military support to civil authorities (MSCA), the secretary of the Army acts as the DOD executive agent for executing and managing MSCA. He responds to the president when coordinating with the director of the Federal Emergency Management Agency (FEMA).

A-8. Federal assistance to a state or territory is provided under the overall direction of the federal coordinating officer (FCO), appointed by FEMA on behalf of the president after the president has declared a "disaster." In coordination with the state, FEMA will send in the emergency response team consisting of selected federal agency representatives to assess damage, establish the disaster field office, and work at the state emergency operations center. The FCO for FEMA must approve all taskings (known as mission

assignments) for the DOD to be reimbursed for its incremental costs for the mission. When a domestic disaster occurs, FEMA's catastrophic disaster response group (CDRG) and emergency support team (EST) form at the FEMA headquarters. The CDRG is the coordinating group that addresses policy issues and support requirements from the FCO and emergency support function response elements from the field. The EST, an interagency group comprised of representatives from the ten primary federal agencies (including the DOD) and the FEMA staff, resolves issues.

A-9. Acting through the Chairman of the Joint Chiefs of Staff and Director of Military Support (DOMS) (the DOD representative on the CDRG), the secretary of defense approves an execute order designating the supported combatant commander and operating agent. This order also delineates support relationships; directs the US Army Corps of Engineers to begin disaster site support; and directs the Commander in Chief, US Transportation Command to begin unit or equipment movement as required by the supported combatant commander. Acting through DOMS, the secretary of the Army tasks and coordinates with the services and other DOD elements or other primary agencies under the FRP and with the mission assigned by FEMA.

A-10. The supported combatant commander designates a component command as a headquarters to execute the disaster relief operation. This headquarters will appoint and deploy a defense coordinating officer (DCO) and, based on the severity of the situation, may also deploy a joint task force (JTF). The DCO works with the FCO to integrate JTF efforts in support of the operation. The DCO serves as the on-scene military point of contact for the FCO and principal representatives of other USG agencies participating in the relief operation. As a practical guide, the DCO and the JTF commander is not the same individual because each has different responsibilities and assets. Separating these distinct functions allows the JTF commander to operate freely in the disaster area, while the DCO focuses on validating tasks and coordinating DOD response activities in the disaster field office. Within the continental US, the Commander in Chief, US Joint Forces Command—through its Army Component Forces Command or the Continental United States Army (CONUSA)—can provide the JTF headquarters. The CONUSA has regionally oriented commands with regional boundaries. These headquarters interact daily with state and local authorities, the FEMA regions, and other federal agencies and provide a foundation for a rapid and smooth transition to support operations during periods of disaster response.

A-11. In addition, other agencies may request DOD assistance as part of a federal response to domestic environmental disasters. Normally, such assistance will be provided based on requests from the Environmental Protection Agency, US Coast Guard, or Department of Interior as the lead agency. Examples include flooding and radiological and hazardous material accidents or incidents. While the DOMS normally coordinates DOD response to domestic emergencies, the military may also respond when an interdepartmental memorandum of agreement is in effect.

STATE AND LOCAL AUTHORITIES

A-12. DOD interaction with state and local authorities can take the visible form of MSCA or the more routine involvement of commanders of DOD

installations with state, county, and municipal governments. These activities include contingency planning with local governments and field offices of federal agencies and community and social activities.

A-13. Each state governor is supported in a contingency by the state or territorial Army and Air National Guard under the command of the state or territorial adjutant general. DOD support is generally provided to assist or augment skills and resources to a federal agency field office or to a state or local agency responsible for a particular activity.

A-14. Each state and territory has an office of emergency services (OES) or an equivalent responsible for preparedness planning and assisting the governor in directing responses to emergencies. The OES coordinates state or territorial assistance to its local governments through authority of the governor or adjutant general, but it does not provide cross-border assistance. In some states and territories, the adjutant general is designated as the senior state emergency official (emergency manager). In other state and territories, the adjutant general is usually equivalent to the state emergency manager. The state usually designates a state coordinating officer (SCO), with authorities similar to the FCO, to coordinate and integrate federal and state activities.

A-15. Lower echelons establish relationships similar to those of DCO, FCO, and SCO to facilitate coordination. For example, Army installation commanders may work with local mayors to align capabilities with needs.

A-16. Federal support to law enforcement agencies can be coordinated with the state or territory adjutant general, the OES, or principal law enforcement agency, depending on the operation. Coordinating counterdrug operations under federal and state oversight can be low-key, with interagency activities taking place in specific localities.

A-17. Commanders rendering aid at the request of local authorities to prevent human suffering, save lives, or mitigate great property damage are authorized to provide immediate response. One example is reacting to storm devastation in a nearby community. If requested by local authorities, an Army installation commander with appropriate resources can immediately act, with coordination of state and federal activities to follow. This immediate response by commanders does not take precedence over their primary mission. Commanders should seek guidance through the chain of command regarding continuing assistance whenever Army resources are committed under immediate response circumstances.

A-18. Coordinated activities between installations and the local community can include support for public fire and rescue services, public works, police protection, social services, public health, and hospitals. Routine interagency coordination between the DOD, the Federal Aviation Administration, and the municipality takes place daily where a joint-use Army airfield supports commercial aviation serving the municipality. Examples include military assistance to safety, traffic control, and search and rescue.

FOREIGN OPERATIONS

A-19. US foreign operations are conducted under authority of the president, in line with treaties, conventions, and executive and other agreements to

which the US is a party; relevant statute law; and relevant federal and agency regulations. These operations are conceived and implemented through an interagency process under the general direction and supervision of the National Security Council and its staff. Specific agencies—such as the Department of State, Department of Defense, and CIA—are normally designated as having the lead in the interagency working groups that do the bulk of the day-to-day work involved in implementing policy.

THEATER ORIENTATION

A-20. Within a theater, the geographic combatant commander plans and implements theater and regional military strategies that require interagency coordination. Coordination between the DOD and other USG agencies may occur in a country team or within a combatant command. In some operations, a special representative of the president or special envoy of the UN Secretary General may be involved. Many USG organizations are regionally focused, such as the Department of State (DOS) in its regional bureaus and the US Agency for International Development (USAID). In individual countries, the ambassador and country team supervise and direct the overall foreign assistance program.

A-21. The joint campaign plan is based on the commander's concept. This plan presents a broad vision of the required aim or end state and how operations will be sequenced and synchronized to achieve objectives. A campaign plan is essential for laying out a clear, definable path linking the mission to the desired end state. Such a plan enables commanders to help political leaders visualize operational requirements for achieving objectives. Given the systematic military approach to problem solving, often the combatant commander formally or informally functions as the lead organizer of many operations. JP 3-08 outlines how to develop and execute a campaign plan in the interagency arena.

A-22. A political advisor (POLAD) is an officer from the DOS. Combatant commanders are usually augmented with a POLAD. Army component commanders in multinational operations and other operations may also be augmented with a POLAD. He provides diplomatic considerations and enables informal links with embassies in the area of responsibility and with the DOS. The foreign policy advisor supplies information regarding DOS policy goals and objectives relevant to the geographic combatant commander's theater strategy. Other USG agencies also may detail liaison personnel to operational level staffs when requested to improve interagency coordination.

DEPARTMENT OF DEFENSE

A-23. The DOD coordinates with the DOS and other USG agencies on many issues including—

- Bilateral and multilateral military relationships.
- Treaties involving DOD interests.
- Technology transfers.
- Armaments cooperation and control.
- Humanitarian assistance.
- Peace operations (including those under the auspices of the UN).

DEPARTMENT OF STATE

A-24. The Department of State is the agency of the USG responsible for planning and implementing the foreign policy of the United States. The DOS is headed by the secretary of state, who is the ranking member of the president’s cabinet and fourth in presidential succession. The secretary of state is the president’s principal advisor on conducting foreign affairs and formulating foreign policy. In its diplomatic role, the DOS is an important source of foreign affairs data, national security and economic information, and data on the policies and inner workings of the countries. In its consular function, it provides notarial and citizenship services to American citizens abroad and assists in implementing US immigration and naturalization laws.

Embassy Organizations

A-25. **Country Team.** The US *country team* is the senior, in-country, United States coordinating and supervising body, headed by the chief of the United States diplomatic mission (the ambassador) (JP 1-02). It is comprised of the senior member of each represented US department or agency present in the country, as desired by the ambassador. The country team composition varies widely depending on specific US national interests, the desires of the ambassador, the situation in the country, and the number and level of presence of US agencies. Figure A-1 shows some possible members of the country team.

- | Country Team Members |
|---|
| • Ambassador |
| • Deputy Chief of Mission |
| • Chief of Political Section |
| • US Defense Representative Security Assistance Officer, or Defense Attaché |
| • Consular Officer |
| • Administration Officer |
| • Chief of Station |
| • Commercial and/or Economics Officer |
| • Regional Security Officer |
| • Regional Medical Officer |
| • Public Affairs Officer |
| • USAID Representative |

Figure A-1. Likely Members of the Ambassador’s Country Team

A-26. A country team facilitates interagency action on recommendations from the field and implements effective execution of US programs and policies. It provides the foundation for rapid interagency consultation and action on recommendations from the field and effective execution of US missions, programs, and policies. A country team is relatively small and may not be adequate for every need. A country team may not exist in every country, or it may be inoperative due to damage or casualties from a natural or man-made disaster. Country teams have generally received some crisis management training, but they are usually not prepared to plan in detail. The relationship with military chains of command is frequently ad hoc.

A-27. **Defense Attaché Office.** The Defense Attaché Office (DAO), which consists of one or more defense attachés and support personnel, observes and reports on the country’s military and political-military situation. This information can be valuable when planning and executing various missions in the country including noncombatant evacuation operations (NEOs), support to counterdrug and counterinsurgency, and others. DAO personnel are active

duty military attached to the embassy in a diplomatic status. The Defense Intelligence Agency rates and funds defense attachés. They may add to the daily embassy situation report and other written intelligence-related information. All military personnel, even those not assigned to the embassy or under direct control of the ambassador, should coordinate their activities through the senior defense representative (which may be the Security Assistance Organization or the defense attaché, depending on the country.) The DAO duties also include liaising with host-nation defense officials on military matters related to threat assessments, intelligence, and in-country capabilities. A smaller embassy may not have a defense attaché present; rather it depends on a regional attaché who is accredited to the host nation but stationed elsewhere.

A-28. Security Assistance Organization. The security assistance organization (SAO) maintains a liaison with the host-nation military forces. It is the most important military activity related to foreign internal defense under the ambassador's supervision. The SAO assists host-nation security forces by planning and administering military aspects of the security assistance program. It also helps the US country team communicate host-nation assistance needs to policy and budget officials in the US government. In addition, the SAO oversees training and assistance teams temporarily assigned to the host nation (HN). The law prevents the SAO from giving direct training assistance. Instead, training is provided through special teams and organizations assigned to limited tasks for specific periods, such as mobile training and technical assistance teams.

A-29. The SAO is a joint organization. The chief of the US diplomatic mission directs and supervises the SAO chief to accomplish the SAO's security assistance mission. The geographic combatant commander commands the SAO in all matters that are not functions of the chief of the US diplomatic mission. The director of the Defense Security Cooperation Agency prescribes policy for managing security assistance programs by the SAO.

A-30. The SAO may be known in country by many names according to the number of persons assigned, the functions performed, or the desires of the HN. Typical SAO designations include a joint US military assistance group, military liaison office, US military training mission, and office of defense cooperation. In countries where the US has no SAO, another member of the mission oversees security assistance. In many countries, security assistance functions are performed within the DAO. The defense attaché may also serve as the SAO.

A-31. The US tailors each SAO to the needs of its HN; thus, there is no standard SAO. However, a large SAO normally has Army, Navy, and Air Force components. Each component must accomplish its service portion of security assistance activities. A small SAO has divisions by function but no separate service components.

A-32. The primary functions of security assistance personnel are logistics management, fiscal management, training management, and contract administration of country security assistance programs. Security assistance personnel maintain a liaison with host-nation defense establishments. They operate with the host-nation military—primarily at the national level—to

interpret US policies, resolve problems in materiel delivery, and obtain technical assistance for defective materiel. They assess the host-nation military capabilities and requirements.

A-33. The SAO provides host-nation governments with information necessary to make decisions about acquiring and using US defense articles and services. (These services include training under the auspices of US security assistance programs.) It obtains information to evaluate the host-nation military's capability to employ and maintain the equipment requested. The SAO processes security assistance proposals of foreign governments. It also keeps communicating with host-nation defense officials on military matters, such as the threat and host-nation military capabilities.

A-34. Documents describing SAO responsibilities and functions include DODD 5105.65 and DODD 5132.3. The former establishes the responsibilities, functions, authorities, and relationships of the Defense Security Cooperation Agency as an agency of the DOD. The latter establishes DOD policy and assigns responsibilities pursuant to The Foreign Assistance Act of 1961, as amended, the Arms Control Act, as amended, and related statutory authorities, executive orders, and policies established by the secretary of state relating to the administration of security assistance.

Embassy Representatives

A-35. **Chief of Mission.** The chief of mission (the ambassador) has authority over all elements of the USG in country, except forces assigned to a combatant commander. The ambassador represents the president but takes policy guidance from the secretary of state through regional bureaus. The ambassador integrates the programs and resources of all USG agencies represented on the country team. As the president's representative in the HN, he has extraordinary authority. He may use the country team as a coordinating mechanism that can be fine-tuned and tailored to each crisis as it arises, based on the problem with little need for written rules. The ambassador functions at both the operational and tactical levels, where recommendations and considerations for crisis action planning are provided directly to the geographic combatant commander or senior military representative in the area.

A-36. The president gives the chief of mission immediate direction and control over USG personnel in the country. This does not include personnel in another mission, assigned to an international organization, or assigned to a combatant command, including their subordinate elements. The chief of mission ensures that all USG activities in the country serve US interests as well as regional and international objectives. He promotes positive program direction by seeing that all activities are necessary, are efficiently and economically run, and are effectively interrelated.

A-37. **Deputy Chief of Mission.** The deputy chief of mission (DCM) is the senior diplomatic official in the embassy below the rank of ambassador. The DCM has the diplomatic title of minister, minister-counselor, or counselor (depending on the mission size) and is usually a career Foreign Service Officer. He usually chairs the emergency action committee (EAC) meetings and

coordinates embassy staff. The DCM helps ensure that all US in-country activities best serve US interests.

A-38. US Defense Representative. The US Defense Representative (USDR) is an additional title assigned to a military officer serving in a specifically designated position. This duty title may be assigned to either the defense attaché or the security assistance officer. The USDR represents the secretary of defense, the chairman of the Joint Chiefs of Staff, and the geographic combatant commander. He coordinates administrative, security, and logistic matters to USG officials for all DOD noncombatant command elements in the foreign country in which the USDR is assigned.

A-39. Chief of Station. The chief of station is the senior intelligence advisor to the ambassador. He is an excellent source of information on the country and the current situation.

A-40. Administration Officer. The administration officer oversees various activities at the embassy compound. These activities may include security at small posts; running the commissary, motor pool, and maintenance activities; and handling monetary aspects of embassy business, including foreign service national payroll, cash collection, and the budget. At a small post with no security officer assigned, the administration officer assumes the functions of the post security officer and has operational control of the Marine Security Guard (MSG) detachment. The general services officer and information management officer work for the administration officer:

- The general services officer is responsible for buildings, grounds, construction, vehicles, and maintenance.
- The information management officer runs the post communications center; processes and tracks all classified pouch material; and oversees the computer system at the embassy. He is the point of contact for the post's communication capabilities.

A-41. Political Officer. The political officer reports on political developments, negotiates with the host-nation government, and represents views and policies of the USG. He maintains regular contact with host-nation officials, political and labor leaders, and other influential citizens of the HN, as well as other countries' diplomats. The political officer is a major contributor to the overall intelligence picture.

A-42. Commercial and/or Economic Officer. This officer analyzes, reports on, and advises superiors, DOS, and DOD personnel on economic matters in the HN. He also negotiates with the HN on trade and financial issues.

A-43. Consular Officer. Consular officers screen, process, and grant US passports and visas. Other duties mandated by law include attending to the welfare of US citizens and maintaining a census of US nationals in the HN. During NEOs, the consular officer provides personnel to screen documents of all potential evacuees and instructs any evacuation control center personnel who staff processing stations.

A-44. Regional Medical Officer. This officer is qualified for general practice and can set up triage, trauma, and mass casualty operations. He may also advise the JTF on indigenous diseases and proper prophylactic procedures for forces executing a NEO. These officers are only found in certain

embassies where the necessary support exists for them to carry out their duties.

A-45. **Regional Security Officer.** The regional security officer (RSO) is a DOS diplomatic security agent responsible for the security functions of all US embassies and consulates in a given country. He directs the MSG detachment via the detachment commander. Similar to the regional medical officer, the RSO is found in all but the smallest embassies. The RSO oversees:

- **Post Security Officer.** Posts with no RSO have a post security officer (PSO). The PSO has general security duties at a specific embassy (or consulate) and is usually the administration officer. The PSO is supported by a designated RSO in a nearby country.
- **Mobile Security Division.** The Mobile Security Division (MSD) consists of DOS employees of the Diplomatic Security Service who respond to crises in foreign countries. The MSD can respond to increased threats or critical security needs at an embassy, provide additional security, and provide immediate response to a security-related incident.
- **Local Guard Force.** Embassies enhance security by hiring civilian security guards to provide perimeter security.

A-46. **Public Affairs Officer.** The public affairs officer (PAO) is the ambassador's advisor concerning public affairs and overseer of US Cultural Center operations. If the situation permits during an emergency, the PAO is responsible for all press releases and inquiries for information directed to the embassy. The PAO usually speaks at press conferences that the ambassador cannot attend.

A-47. **Marine Security Guard Detachment.** A MSG detachment has, on average, six Marines, with the maximum number assigned dictated by need. The Marine detachment commander is normally a member of the EAC and responsible to the RSO or PSO for US personnel and internal security and protection of classified material. Administrative control of detachment Marines is through their company commander, the regional Marine officer.

CENTRAL INTELLIGENCE AGENCY

A-48. The CIA coordinates the intelligence activities of other US departments and agencies. It advises and recommends policy to the NSC on matters regarding intelligence activities of all governmental departments and agencies. It correlates and evaluates this intelligence and disseminates it in the government. The CIA also conducts special activities approved by the president. Executive Order 12333 directs that "no agency except the CIA (or the Armed Forces of the United States in time of war declared by Congress or during any period covered by a report from the President to the Congress under the War Powers Resolution [87 Stat. 855] [50 USC 1541 et seq.]) may conduct any special activity unless the President determines that another agency is more likely to achieve a particular objective."

US AGENCY FOR INTERNATIONAL DEVELOPMENT

A-49. The USAID manages US developmental, humanitarian, and civic assistance activities. The USAID supervises and gives general direction on all nonmilitary assistance programs under the Foreign Assistance Act of 1961,

Public Law 480, and related legislation. The agency plans and implements overseas programs to improve economic and social conditions. The agency administers civic assistance programs in conjunction with the Department of Agriculture. Under arrangements made with USAID, US affiliates of international voluntary agencies conduct most of the food programs under Public Law 480. Although USAID is concerned primarily with developmental assistance and civic assistance, some programs it administers are security-related. The agency representative in the HN fully coordinates these programs with the DOD representative.

A-50. The disaster assistance response team (DART) is an important USG capability in foreign humanitarian crisis or complex emergencies. The USAID's Office of US Foreign Disaster Assistance developed DART to provide rapid response to foreign disasters. A DART provides various trained specialists to assist US embassies and USAID missions with managing the USG response to foreign disasters. JP 3-07.6 has more information.

NONGOVERNMENTAL ORGANIZATIONS

A-51. Nongovernmental organizations (NGOs) do not operate within the military or the governmental hierarchy or the chain of command. Therefore, the relationship between the armed forces and NGOs is best characterized as an association or partnership. The US military ordinarily tries to orchestrate its interaction with NGOs by establishing a civil-military operations center (CMOC).

A-52. Where long-term problems precede a deepening crisis, NGOs are frequently present when US forces arrive, or have been in the country until forced to temporarily leave for security reasons. They often remain long after military forces have departed. Some NGOs are independent, diverse, flexible, grassroots-focused, primary relief providers. Others, however, provide a channel for funds and hire other primary relief NGOs (usually local) to carry out the programs. These organizations play an important role in providing support to host nations. NGOs provide assistance to over 250 million people annually. Their worldwide contributions total between 9 and 10 billion dollars each year—more than any single nation or international body (such as the UN). Most funds used by most NGOs come from governments or international organizations; that is, the NGOs act as implementing partners for funding agencies. Because they can respond quickly and effectively to crises, they can lessen the civil-military resources that commanders would otherwise have to devote to an operation. Though differences may exist between military forces and civilian agencies, short-term objectives are frequently similar. Discovering this common ground is essential to unity of effort. In the final analysis, the commander's assessment of conditions and resources must include the activities and capabilities of NGOs and then integrate them into the selected course of action.

A-53. NGOs may range in size and experience from those with multimillion-dollar budgets and decades of global experience in developmental and humanitarian relief to newly created small organizations dedicated to a particular emergency or disaster. Some NGOs are not relief-oriented, but carry out long-term development projects. The professionalism, capability, equipment and other resources, and expertise vary greatly from one NGO to another.

NGOs are involved in such diverse activities as human rights, education, technical projects, relief activities, refugee assistance, public policy, and development programs. The connection between NGOs and the DOD is ad hoc, with no specific statutory link. While their focus remains grassroots and their connections informal, NGOs are major players in many stability operations and support operations. They affect many lives and control resources, making NGOs powerful in the interagency community. UN and USG agencies often use individual organizations to carry out specific relief functions.

A-54. Army forces may encounter many NGOs in an area of operations. In Somalia, there were 78 private organizations contributing relief support and, in the Rwanda crisis, over 100 relief organizations assisted the UN relief. Over 350 such agencies are registered with the USAID. The first line of security for most NGOs is adherence to a strict principle of neutrality. Actions which blur the distinction between relief workers and military forces may be perceived as a threat to this principle, resulting in increased risk to civilian aid workers.

A-55. The extensive involvement, local contacts, and experience make NGOs valuable sources of information about local and regional governments and civilian attitudes toward the operation. While some organizations seek the protection of the armed forces or the use of military aircraft to move relief supplies to overseas destinations, others may avoid a close affiliation with military forces, preferring autonomous operations. Their rationale may be fear of compromising their position with the local populace or suspicion that military forces intend to take control of, influence, or even prevent their operations. Staffs should consult these organizations, along with the host-nation government (if applicable), to identify local issues and concerns that the proposed public affairs guidance should reflect.

A-56. Public affairs planning should also include identifying points of contact with NGOs that will operate in an affected area to arrange referrals of media queries regarding their operations to an authorized spokesperson. Military spokespersons should only comment on NGOs based on specific guidance. The office of the assistant secretary of defense (public affairs) or regional organization (such as the North Atlantic Treaty Organization [NATO]) provides guidance in cooperation with the in-country headquarters of the organization.

A-57. The president may determine that it is in the national interest to task US military forces with missions that bring them into close contact with (if not support of) NGOs. All participants then benefit when they closely coordinate their activities. A climate of cooperation between NGOs and the military forces should be the goal. Missions to support NGOs are short-term due to extraordinary events. In most situations, the NGOs need logistics, communication, and security capabilities. However, in such missions, the role of the armed forces should be to enable—not perform—NGO tasks. Often US military assistance has proven to be the critical difference that enabled success of an operation. Commanders should also understand that mutually beneficial arrangements between the armed forces and NGOs may be critical to the success of the operation. Appendix B of JP 3-08 describes many agencies that commanders may encounter in an area of operations.

A-58. The International Red Cross and Red Crescent Movement is a well-known NGO. It consists of three independent parts: the International Committee of the Red Cross (ICRC), the National Societies, and the Federation.

A-59. Five citizens of Geneva founded the ICRC in 1863 as the “International Committee for Relief of Wounded.” Voluntary contributions by governments (the majority of funding), the national Red Cross and Red Crescent Societies, and private sources finance it. The ICRC mission is, on the basis of the Geneva Conventions and Protocols, to protect and assist victims of armed conflict and those affected by internal disturbances or tension, specifically to—

- Visit and interview, without witnesses, prisoners of war and detained or interned civilians.
- Provide aid to the populations of occupied territories.
- Search for missing persons and to transmit messages to prisoners of war and detained civilians.
- Offer services for establishing hospital zones, localities, and security.
- Receive requests for aid from protected persons.
- Exercise its right of initiative to pursue the above tasks and to offer its services to the parties of internal disputes.

A-60. In its own country, a national Red Cross (such as the American Red Cross) or Red Crescent society assists the public authorities in humanitarian matters. It primarily backs up the military medical services during conflict. The International Federation of Red Cross and Red Crescent Societies supports the humanitarian activities carried out by the national societies.

REGIONAL AND INTERNATIONAL ORGANIZATIONS

A-61. Regional and international organizations possess area or global influence. Regional examples include NATO, the Organization for African Unity, Organization of American States, Western European Union, and Organization for Security and Cooperation in Europe. International examples include the UN, its agencies, and the ICRC movement. These organizations have well-defined structures, roles, and responsibilities and are usually equipped with the resources and expertise to participate in complex interagency operations. The following describes formal or informal ties between the United States and some of the larger regional and international organizations.

The North Atlantic Treaty Organization

A-62. NATO is a good example of the interagency process on a regional level. NATO has been challenged by the demands for cooperation that characterize every regional effort and has endured for over 50 years.

A-63. US efforts within NATO are led and coordinated by the permanent representative. He is appointed by the president and has the rank and status of ambassador extraordinary and chief of mission (Title 22 USC, section 3901). Figure A-2 lists the 19 member countries of NATO.

NATO Members			
Belgium	Canada	Czech Republic	Denmark
France	Germany	Greece	Hungary
Iceland	Italy	Luxembourg	Netherlands
Norway	Poland	Portugal	Spain
Turkey	United Kingdom	United States	

Figure A-2. Member Countries of NATO

A-64. Over the years, the alliance has undergone changes in organization, orientation, and membership. Following the end of the Cold War, the alliance was restructured to enable it to participate in peacekeeping and crisis management tasks undertaken in cooperation with countries that are not members of the alliance and with other international organizations. This is evident in NATO support to UN operations in the former Yugoslavia.

A-65. In Kosovo, Operation ALLIED FORCE demonstrated for the first time NATO’s ability to conduct offensive operations to compel a noncompliant to comply with the alliance collective will. The alliance has been actively involved in planning, preparing, and implementing peace operations, such as protection for humanitarian relief and support for UN monitoring of heavy weapons.

A-66. Beyond day-to-day operations, training exercises, and logistics authorized by statute, extraordinary use of US military force with NATO in both war and military operations other than war requires presidential approval. They may also be subject to congressional review, including those employments authorized and limited by the War Powers Act. (See Appendix B.)

The United Nations

A-67. Coordination with the UN begins at the national level with the Department of State, through the US permanent representative to the UN. In some administrations, this individual has been granted cabinet status. The US representative is assisted at the US mission to the UN by a staff of some 100 foreign service, military, and civilian personnel. This staff includes a military assistant who coordinates appropriate military interests primarily with the UN Office for the Coordination of Humanitarian Affairs (OCHA) and the UN Department of Peacekeeping Operations (UNDPKO).

A-68. The Foreign Assistance Act of 1961, the UN Participation Act of 1945, and Executive Order 10206 authorize various types of US military support to the UN, either on a reimbursable or nonreimbursable basis. US military operations in support of the UN usually fall within Chapter VI or Chapter VII of the UN Charter. (See JP 3-08 for details regarding the UN Charter and Chapters VI and VII of that charter.)

A-69. The UN normally authorizes peace operations or conducts humanitarian assistance under the provisions of a resolution or mandate from the security council or the general assembly. Politicians and diplomats trying to reach a compromise develop mandates. Because of this, military commanders have often found it difficult to translate these mandates into workable mission orders. Additionally, fast-changing events on the ground can quickly

render a mandate obsolete. Commanders must quickly inform the chain of command of significant changes in the situation.

A-70. The UN headquarters coordinates peace operations and humanitarian assistance around the world. However, it does not have a system for conducting these operations that parallel that of the United States. The UN organizational structure consists of the headquarters and the operational field elements. Thus, a strategic- and tactical-level equivalent to the armed forces exists, but no operational counterpart.

A-71. The OCHA coordinates humanitarian operations, particularly to make the necessary arrangements for the timely and effective delivery of assistance by UN relief organizations. In complex emergencies, the department appoints a field-based humanitarian coordinator who works under the authority of the special representative to the UN Secretary General (SYG).

A-72. In serious emergencies, the SYG may appoint a special representative to direct day-to-day operations. He reports to both the SYG directly and advises UNDPKO and OCHA at UN headquarters.

A-73. The OCHA is a part of the UN secretariat. It coordinates UN assistance in humanitarian crises that go beyond the capacity and mandate of any single humanitarian organization. The head of this office, the emergency relief coordinator, chairs the Interagency Standing Committee, thus uniting all major humanitarian actors inside and outside the UN system. This committee works to analyze a given crisis. It also works to ensure interagency decision making when responding to complex emergencies as well as when developing humanitarian policy.

A-74. The UNDPKO is the operational arm of the SYG for the day-to-day management of peacekeeping operations. In this capacity, the department acts as the main channel of communications between UN headquarters and the field.

A-75. The United Nations Development Program is a separate agency that is part of the UN system. As indicated by its name, this agency focuses more on long-term development than emergencies. The in-country program representative is often the UN resident coordinator, responsible to mobilize and manage the local UN humanitarian resources and provide direction for the field relief effort. If conflict erupts, a special representative to the SYG—who has greater expertise in emergencies and negotiations—may replace the UN resident coordinator.

A-76. UN-sponsored operations normally employ a force under a single commander. The force commander is appointed by the SYG with the consent of the UN security council. He reports directly to the special representative to the SYG or to the SYG. In any multinational operation, the US commander will retain command authority over all assigned US forces. The US chain of command will flow from the president through the combatant commander. With presidential authorization, the multinational force commander may exercise operational control over US units in specific operations authorized by the UN security council.

CIVIL-MILITARY OPERATIONS CENTER

A-77. The civil-military operations center is an ad hoc coordination center established and directed by the commander’s civil-military operations officer. The CMOC facilitates the coordination of activities of military forces with USG agencies, NGOs, regional and international organizations, and local authorities. The size, structure, and location of the CMOC are situation dependent. As a coordination center, the CMOC is neither a unit nor an organization. (See FM 3-57.)

A-78. If there is a host-nation government, it has the presumptive right to establish the mechanisms for civil-military coordination. In Albania, for example, the primary mechanism for such coordination was established and hosted by the Albanian government.

A-79. The CMOC may be neither the first coordinating mechanism nor the primary one, depending on the situation. Strong consideration should be given to co-locating CMOC functions with previously existing mechanisms, such as an on-site coordination center, a humanitarian operations center, or a civil-military cooperation center (see Figure A-3.) Force protection is always a concern for the commander when considering where to locate the CMOC. While placing the CMOC “inside the wire” enhances force protection, it also can interfere with its ability to interact with NGOs and other actors. The commander must consider this difficulty when analyzing METT-TC—mission, enemy, terrain and weather, troops and support available, time available, civil considerations.

A-80. Coordination centers have various names and functions according to the mission and needs of the establishing commander. The CMOC is the type of coordination center most employed by Army commanders. However, a limited discussion of several others may also be helpful. (See Figure A-3.) These coordination centers are discussed in more detail in JP 3-57.

Coordinating Center	Description
Humanitarian Operations Center (HOC)	This center is usually established by a host-nation government or UN. The HOC coordinates the overall relief strategy in large-scale FHA operations. It is responsible for policy making and coordinating, but does not exercise command and control. The HOC may submit requests for support to a commander through a CMOC. HOCs were established in the UN operations in Somalia and Rwanda.
On-Site Operations Coordination Center (OSOCC)	The OSOCC is a support organization to a HOC. It assists in gathering, evaluating, collecting, and disseminating HOC information. During Operation SUPPORT HOPE in Rwanda, the UN deployed an OSOCC—which had essentially the same functions as a CMOC—and helped transmit CMOC responsibilities to the UN.
Civil-Military Cooperation (CIMIC) Center	CIMIC is a NATO doctrinal concept that roughly equates to the US term “civil-military operations.” Thus, when the NATO-led Implementation Force in Bosnia-Herzegovina established a center for coordination with the NGO community, it was known as the CIMIC center rather than a CMOC, but it performed the same functions.

Figure A-3. Example Coordination Centers

A-81. Military or civilian representatives from different agencies and organizations compose the CMOC. Mission requirements, command directives, operations security, workload, and accessibility to nonmilitary agencies impact on its actual organization. Figure A-4 shows a sample CMOC organization.

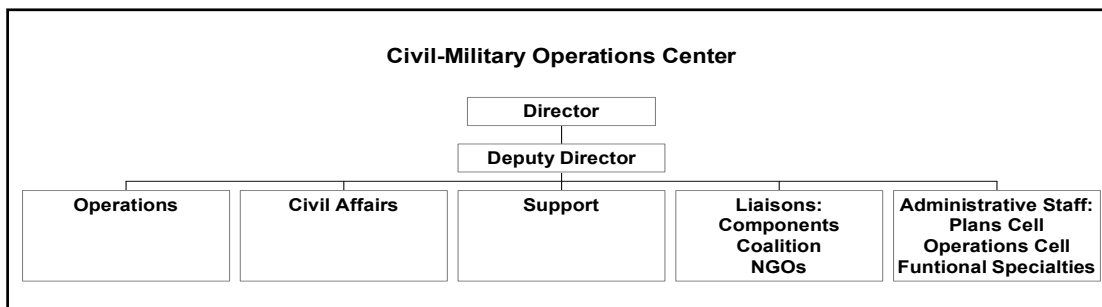

Figure A-4. Model Organization of a CMOC

A-82. The number of CMOCs supporting a given operation may vary based on mission analysis. Commanders at any echelon may establish a CMOC. The decision to establish a CMOC stems from civil-military coordination requirements. The distance from the headquarters serving a particular geographic or tactical area can also influence the decision. A JTF often establishes a CMOC; however, in operations where the joint force headquarters is located in one locale and units are spread throughout the joint area of operations, subordinate Army commanders may establish sector CMOCs.

A-83. A CMOC usually conducts daily meetings to identify needs and available resources. Validated requests go to the appropriate JTF, Army, or agency representative for action. CMOC tasks may include—

- Facilitating civil-military coordination between those involved:
 - Host nation.
 - International or regional organizations, such as the UN and NATO.
 - USG agencies—such as USAID and country team—to include the disaster assistance response team deployed to the scene by USAID’s Office of Foreign Disaster Assistance.
 - US or multinational commands.
 - NGOs.
- Assisting in transferring operational responsibility to nonmilitary agencies.
- Receiving, validating, coordinating, and monitoring requests from NGOs for routine and emergency military support.
- Coordinating requests to NGOs for their support.
- Convening ad hoc mission planning groups to address complex military missions that support NGO requirements (such as convoy escort and management as well as security of refugee camps and feeding centers).
- Convening follow-on assessment groups.
- Providing situation reports regarding force operations, security, and other information for participants in the collective effort.

- Chairing meetings on NGO logistics prioritization issues and liaising with port and airfield control authorities.
- Facilitating the creation and organization of a logistics distribution system for food, water, and medical relief efforts.
- Providing updated strike data to support unexploded explosive ordnance clearance and mine awareness activities.
- Providing daily security update, to include incidents of crime, landmine strikes, militia activity, and general safety.

A-84. The PAO should attend daily CMOC meetings. As an active member of the CMOC, the PAO must ensure that member agencies agree on message and press releases and develop a group consensus in response to media queries. Although each agency's message need not be identical, agencies must not contradict each other.

LIAISON

A-85. Liaison maintains contact and communication between elements of military forces and other agencies to ensure military understanding and unity of purpose and action. It is essential in most stability operations and support operations because of the variety of external participants and the coordination challenges present.

A-86. Liaison officers (LNOs) are a focal point for communications in joint, multinational, and interagency operations. LNOs centralize direction and facilitate understanding while conducting operations with external agencies or forces (see also Appendix E of FM 6-0). Supported agencies, departments, and organizations need a much clearer understanding of the military planning process. This is best accomplished by direct liaison. LNOs normally work closely with the operations officer to seek and resolve interagency problems. Liaison teams should establish authoritative representation of the commander, accurately interpret the commander's intentions, and explain the capabilities of the force. Conversely, the teams interpret the intentions and capabilities of the nonmilitary organizations. Liaison teams provide input while developing courses of action for future operations. They also work to maximize current operations through proactive interaction with the agencies, departments, and organizations to which they are attached.

A-87. The professional abilities of the LNO determine a successful liaison. Additional factors that contribute to successful liaisons are—

- Knowledge of the doctrine, capabilities, procedures, and culture of their organizations.
- Transportation.
- Language ability.
- Regional orientation.
- Communications.
- Single point of contact in the headquarters.
- In support of humanitarian assistance missions, functional skills and experience aligning with the need for medical and logistics expertise.

A-88. Civil affairs or special forces liaison elements may be available to serve as LNOs. Using contracted interpreters to augment liaison teams may be another option, although in some cases their loyalties may affect reliability.

A-89. Liaison teams are formed when a 24-hour representational capability is required. Teams are tailored to the specific situation and may require CJCS-controlled communications assets. Individual LNOs are assigned when 24-hour representation is not required and adequate communications with the JTF staff are available.

Appendix B

The Law in Stability Operations and Support Operations

B-1. Law, regulation, and policy closely control the actions of the armed forces. Military forces rely on a declaration of war, an executive order, or other legal authority to direct their action. Congress must also appropriate funds. Commanders and staff officers must look closely at the law to see whether an action being considered is allowed. The rules vary by time and place; what can be done under some circumstances is forbidden in others. When the time for execution comes, Army forces must look at the policies prescribed by law and regulation and conduct operations within these rules.

B-2. This manual views laws and regulations in two ways. First, it considers the laws prevailing at the time of its writing and attempts to explain some of the more important ones. It does not attempt a definitive explanation of the law; readers should look to their staff judge advocates (SJAs) for that. Second, it anticipates that laws and regulations will grant authority necessary to conduct future operations effectively. Laws will define policy and convey specific instructions and authority to military forces to accomplish their mission.

B-3. Consideration of current law introduces the problem of terms of art. These legal terms have meaning under particular circumstances and, in specific contexts, are restricted to some special case of their meaning in ordinary language. Thus, humanitarian assistance means, in ordinary English, any help given by any person to any other person in need. It is motivated by sympathy for human suffering or hardship. This manual uses the term in its ordinary sense. On the other hand, under the authority of Title 10 United States (US) Code (USC), section 401, certain civil-military operations overseas are known as humanitarian and civic assistance. Generally, this manual does not use such terms except when dealing specifically with legal matters. When it does use them, it explains them in context.

APPLICABLE BODIES OF LAW

B-4. Three bodies of law are relevant to the conduct of US military operations in peace and conflict: international law, US law, and host-nation law. In

CONTENTS			
Applicable Bodies of Law	B-1	Appropriations and Authorization Acts.	B-5
International Law	B-2	Fiscal Law	B-5
US Law	B-2	Executive Orders	B-6
Host-Nation Law	B-2	Law of Armed Conflict	B-6
Legal and Regulatory Considerations	B-3	International Agreements	B-7
Posse Comitatus Act	B-3	Robert T. Stafford Disaster Relief Act ...	B-7
Title 10 USC	B-4	War Powers Resolution	B-7
Foreign Assistance Act	B-4	Claims Administration	B-8
Economy Act	B-5	Use of Chemical Herbicides and Riot	
Title 32 USC	B-5	Control Agents	B-8

addition to this appendix, FM 1-04 has specific legal guidelines for stability operations and support operations.

INTERNATIONAL LAW

B-5. International law affects most stability operations and support operations. International law consists mainly of international agreements, such as treaties and customary international law, which includes the agreements and customary law known as the law of war. International agreements prescribe the rights, duties, powers, and privileges of nations relative to particular undertakings. International agreements affect US participation in stability operations and support operations in matters such as—

- The use of force during armed conflict.
- The right of entry of US forces into a foreign country.
- The status of US personnel in the foreign country.
- Construction and operation of US bases.
- Aircraft overflight and landing rights.
- The processing of claims for damage to persons and property.
- The support provided to other armed forces, nongovernmental organizations (NGOs), and local populace.

B-6. The military planner must understand that such agreements or customary international law may govern all aspects of operations carried out in a foreign country. In the absence of a viable host nation's existing domestic law or an appropriate international agreement, aspects of the operations may be controlled by customary international law. In addition, US law and regulation will govern the conduct of such operations.

US LAW

B-7. Operations in peace and conflict must comply with US law, whether as a statute, executive order, regulation, or other directive from a branch or agency of the federal government. The Uniform Code of Military Justice (UCMJ) applies to questions of military justice. The Federal Acquisition Regulation and various statutes govern acquisition of supplies and services for US forces. The Foreign Assistance Act and the Arms Export Control Act pertain to aid given to a foreign country. Various statutes, Executive Order (EO) 12333, and Department of Defense (DOD) and service regulations govern intelligence activities. The Case Act and implementing directives govern the negotiation and conclusion of international agreements. The SJA must actively advise and participate in every stage of the operation, from the initial planning to redeployment.

HOST-NATION LAW

B-8. If a viable host-nation government exists, whether at the national or the local level, domestic laws of the host nation may apply to US forces in that country unless an international agreement provides otherwise. Examples of laws that may inhibit US operations include the fields of immigration, labor, currency exchange, procurement of goods and services, customs and taxes, and criminal and civil liability. A status-of-forces agreement (SOFA) between the US and the host nation may cover these areas during the period of an

operation. Therefore, planners must understand the law to assess whether and how it will adversely affect the operation. Assistance may be available from the local US diplomatic mission or the command judge advocate, or the command may have to rely on other sources for guidance. If local law hinders or otherwise implicates the conduct the operation, commanders should inform the diplomatic mission and request that it negotiate a solution.

LEGAL AND REGULATORY CONSIDERATIONS

B-9. The following considerations show the legal complexities encountered in stability operations and support operations. They provide only a starting point for planning and conducting legal operations in peace and conflict. The SJA is a critical member of the staff and must be involved with conducting all operations. The Center for Law and Military Operations provides additional resources and references for legal considerations in stability operations and support operations.

POSSE COMITATUS ACT

B-10. Posse Comitatus Act is the popular name for the statute (Title 18 USC, section 1385) that makes it a crime to use Army forces to enforce civil law. It is the keystone of a legal philosophy that emphasizes the distinction between the military mission and that of domestic civil law enforcement. Several exceptions to the statute exist that allow, with proper authorization, military support to civilian law enforcement agencies (LEAs). The SJA must review all operations to ensure that they comply with the act. (See Chapter 6.)

Constitutional Exceptions

B-11. Under its inherent authority, the US government must preserve public order and carry out governmental operations within its territorial limits, by force, if necessary. Under the Constitution, two exceptions allow using the military to execute or enforce the law.

B-12. When Necessary to Protect Civilian Property and Functions. A sudden and unexpected civil disturbance, disaster, or calamity may seriously endanger life and property and disrupt normal governmental functions to such an extent that local authorities cannot control the situation. At such times, the federal government may use military force to prevent loss of life or wanton destruction of property and to restore government functions and public order. This exception has rarely been used.

B-13. When Necessary to Protect Federal Property and Functions. The federal government may use military force to protect federal property and federal government functions when local authorities cannot or decline to provide adequate protection.

Statutory Exceptions

B-14. Other statutory exceptions (Title 10 USC, sections 371-380) allow military personnel to provide limited support to civilian LEAs indirectly. Under these laws, the military may share certain information and provide equipment, facilities, and other services to LEAs. The annual National Defense Authorization Act also contains exceptions concerning military support to

civilian authorities fighting illegal drugs. DOD policies for providing support to civilian LEAs, including personnel and equipment, are contained in DOD Directive (DODD) 5525.5. AR 500-51 contains related Army policies. Examples of support that do not violate the Posse Comitatus Act include—

- Loan of equipment and training to operate or repair the equipment. Certain customs and other laws—the Controlled Substances Act and the Immigration and Nationality Act—permit direct operation of this equipment.
- Civilian LEAs' use of installation research facilities.
- Transfer of information acquired during normal military operations.
- Actions that are taken for the primary purpose of furthering a military or foreign affairs function of the US.
- Investigations and other actions related to enforcement of the UCMJ.
- Actions related to a commander's authority to maintain law and order on a military installation or facility.
- Protection of classified military information or equipment.
- When authorized by the president, prevention of loss of life or wanton destruction of property and restoration of governmental function and public order in a civil emergency.
- When authorized by the president, protection of federal property.
- Protection of the president, vice president, and other designated dignitaries.
- Execution of certain warrants relating to enforcement of specified civil rights laws.
- Support of territorial governors if a civil disorder occurs.

B-15. Note: These exceptions must meet the requirements of applicable laws and directives. In addition, there are other exceptions to the Posse Comitatus Act. (See DODD 5525.5.)

TITLE 10 USC

B-16. Title 10 is the "Armed Forces" section of the USC. Chapter 18 gives basic guidance for the interaction of military, reserve component, and civilian LEAs. Guidelines on reimbursement and restrictions on directly participating in law enforcement activities, using information collected during military operations, and using military equipment and facilities are some of the topics covered. Title 10 prohibits the military from directly participating in arrests, searches, seizures, or other similar activity unless authorized by law (such as arrests on military property). The fiscal year (FY) 1989 and subsequent National Defense Authorization Acts have authorized the DOD to provide more support to LEAs in the counterdrug effort.

FOREIGN ASSISTANCE ACT

B-17. "The Mansfield Amendment" to the Foreign Assistance Act (Title 22 USC, section 2291[c][1]) prohibits US personnel from performing foreign law enforcement activities overseas. Under Chapter 8 of Part I of the Foreign Assistance Act, the president may give assistance to eligible countries and international organizations for counterdrug (CD) programs. The 1978

“Kennedy Amendment” to the Foreign Assistance Act (Title 22 USC, section 2304[a][2]) prohibits foreign governments with a record of gross human rights violations from receiving security assistance funds. It also prohibits using the act to support foreign police, prisons, or intelligence operations. Occasional exceptions have been made, so the SJA must be consulted for specific situations.

ECONOMY ACT

B-18. The Economy Act (Title 31 USC, section 1535) requires that other federal agencies reimburse the Department of Defense for services or support provided. Reimbursement for DOD support provided to LEAs is not required when that support—

- Is in the normal course of military training and operations.
- Results in benefit to the DOD that is substantially equivalent to that which would otherwise be obtained from military operations or training.
- Is provided under the authority of section 1004, National Defense Authorization Act for FY 1991, as amended.

TITLE 32 USC

B-19. Title 32 is the “National Guard” section of the USC. Section 112 describes how the secretary of defense may provide funds to state governments (including the District of Columbia, Commonwealth of Puerto Rico, and US territories) for CD operations by the Army National Guard (ARNG) when not in federal service. The Posse Comitatus Act does not apply to troops when not in federal service. Unlike Title 10, this title does not specify how the ARNG may be employed. Each state determines its own employment laws. Nevertheless, under their regulations, members of the ARNG may not participate directly in law enforcement activities. In some cases, however, these soldiers may conduct limited law enforcement activities, such as searches of shipping containers for illegal drugs, if their state law authorizes it. For these reasons, section 112 requires that the plans submitted by the state governors to the secretary of defense specify how the ARNG personnel will provide support to LEAs.

APPROPRIATIONS AND AUTHORIZATION ACTS

B-20. The yearly acts passed to authorize or appropriate funds to the DOD often contain provisions relating to the CD effort. For example, the FY 1989 National Defense Authorization Act tasked the DOD to be the single lead agency of the federal government for detecting and monitoring illegal drug shipments into the US. The FY 1990-91 National Defense Authorization Act tasked the DOD to create an integrated command, control, communications, and technical intelligence network linking the military and the various civilian LEAs. The first of these provisions was subsequently incorporated into permanent law (Title 10 USC, section 124).

FISCAL LAW

B-21. Properly spending funds for operations is important. Failure to apply fiscal principles correctly to federal activities can lead to unauthorized

expenditure and potential criminal or administrative sanctions. The principles are complex; the answers cannot necessarily be derived by applying common sense rules. Funds appropriated must be used for the purpose for which they were appropriated. Additionally, funds may also have specific limitations as to activities for which they can be used. After-the-fact audits by the General Accounting Office and other agencies are common.

EXECUTIVE ORDERS

B-22. EO 12333 regulates the use of national intelligence assets. DODD 5240.1 and DOD 5240.1-R implement for the DOD the provisions of EO 12333 and set forth the conditions under which the DOD can collect information on US persons. Under these provisions, the Department of Defense may collect information on US persons reasonably believed to be engaged in international illegal drug activities. The complexities of these provisions require full legal review of all intelligence activities in addition to prescribed intelligence oversight.

B-23. Intelligence oversight regulations contained in AR 381-10 implements EO 12333. This regulation also provides procedures on—

- Collecting, disseminating, or retaining information on US persons by intelligence components.
- Assistance by intelligence components to law enforcement.
- Reporting violations, investigating violations, and taking corrective action.

LAW OF ARMED CONFLICT

B-24. The law of war applies to all cases of declared war or any other armed conflicts that arise between the US and other nations, even if the state of war is not recognized by one of them. It also applies to cases of partial or total occupation. Common article 2 of the Geneva Conventions discusses such occupations. Armed conflicts such as the Falklands War, the Iran-Iraq War, and Operation DESERT STORM were clearly international armed conflicts to which the law of war applied. While the 1977 Protocol I to the 1949 Geneva Conventions has expanded the application to include certain wars of “national liberation,” the US does not recognize this extension of the law of war.

B-25. In peace operations, such as those in Somalia, Haiti, and Bosnia, the question arises whether the law of war applies. The issue hinges on whether the peace operations forces undertake a combatant role. So far, the US, UN, and NATO believe that their forces have not become combatants, despite carrying out offensive-type operations, such as the use of Task Force Ranger in Somalia and Operations DENY FLIGHT and DELIBERATE FORCE in Bosnia. Although the law of war does not apply to these operations, the US, UN, and NATO have their forces apply the “principles and spirit” of the law of war in these operations.

B-26. This approach is consistent with DOD policy to comply with the law of war “in the conduct of military operations and related activities in armed conflict, however such conflicts are characterized” (DODD 5100.77, paragraph 5.3.1). CJCSI 5810.01B, paragraph 4.a. states that the US forces

“will comply with the law of war during all armed conflicts, however such conflicts are characterized, and, unless otherwise directed by competent authorities.” In applying the DOD policy, however, allowance must be made during these operations. US forces often lack the resources to comply with the law of war to the letter. The US complies with the law of war to the extent “practicable and feasible” (memorandum of W. Hays Parks to the judge advocate general of the Army, 1 October 1990).

INTERNATIONAL AGREEMENTS

B-27. Several international agreements affect stability operations and support operations. These include SOFAs, multilateral conventions, and bilateral agreements. Agreements can also be prepared for specific operations with appropriate delegated authority in accordance with DODD 5530.3 and Army regulations. SOFAs establish the legal status of military personnel in foreign countries. Criminal and civil jurisdiction, taxation, and claims for damages and injuries are a few of the topics usually covered. In the absence of an agreement or some other arrangement with a nation, DOD personnel in foreign countries have no special legal status. They become subject to all the laws and judicial processes of the host nation unless other conventions or agreements create exceptions to that rule.

ROBERT T. STAFFORD DISASTER RELIEF ACT

B-28. The Stafford Act—Title 42 USC, section 121 (and following sections), as amended—is the statutory authority for federal domestic disaster assistance. It empowers the president to establish a program for disaster preparedness and response, which he delegates to the Federal Emergency Management Agency. The Stafford Act provides procedures for declaring an emergency or a major disaster, as well as the type and amount of federal assistance available. The act authorizes the president to provide DOD assets for relief once he formally declares an emergency or a major disaster. He may also provide DOD assets for emergency work on a limited basis before the declaration. DOD Directive 3025.1 contains the Department of Defense policy for providing domestic disaster assistance. AR 500-60 has the Army policy.

WAR POWERS RESOLUTION

B-29. Public Law 93-148, the War Powers Resolution (WPR) of November 1973 (also called the War Powers Act), requires the president to consult with and report to Congress when introducing US armed forces—

- Into hostilities.
- Into situations where imminent involvement in hostilities is clearly indicated by the circumstances.
- Into foreign territories when equipped for combat (except for supply, repair, replacement, and training).
- In numbers that substantially increase the number of US forces equipped for combat in a foreign country.

B-30. The resolution also applies to the “assignment of members of such armed forces to command, coordinate, participate in the movement of, or accompany the regular or irregular military forces of any foreign country or

government when such military forces are engaged, or there exists an imminent threat that such forces will become engaged, in hostilities.”

B-31. Procedures have been established for the legal advisor to the Chairman, Joint Chiefs of Staff (JCS), to review all force deployment actions routed through the JCS to which the WPR may apply. The chairman’s legal advisor subsequently reports to the DOD general counsel concerning the WPR’s applicability. If the DOD general counsel determines that the situation merits further interagency discussion, he consults with the Department of State’s legal advisor and, perhaps, with the attorney general. This process should provide the president with advice concerning the congressional consultation and reporting requirements mandated by the WPR.

B-32. Commanders and military planners should be aware that the advisory and training commitment of US forces might require review for applicability of the WPR. Advisory duties, especially in an insurgency or a counterinsurgency, may fall in the category of actions requiring consultation and reporting.

B-33. If found to be applicable, the WPR requires US forces to withdraw in 60 days of the reporting date or 90 days when the president deems it militarily necessary, unless Congress legislates otherwise.

CLAIMS ADMINISTRATION

B-34. Activities of US military personnel serving in foreign countries occasionally result in personal injuries, deaths, and property damage. Also, members of the armed forces may be injured and their property damaged, lost, or destroyed. Claims against the United States that arise in foreign countries are adjudicated under several statutes and international agreements. Claims are not payable if the injury or damage occurs as a result of combat activities of the armed forces. Planning for stability operations and support operations should include efforts to have the DOD general counsel designate single-service claims responsibility for the operation. This operation should take place in a country not already assigned to a single service for claims purposes. Additionally, every effort must be made to ensure that US personnel do not leave the impression with potential claimants that their claims are payable. Only properly constituted claims commissions may make these determinations.

USE OF CHEMICAL HERBICIDES AND RIOT CONTROL AGENTS

B-35. EO 11850 limits using chemical herbicides and riot control agents. The secretary of defense is tasked with taking all necessary measures to ensure that US forces use neither chemical herbicides nor riot control agents without prior presidential approval. Detailed guidance is in the Joint Strategic Capabilities Plan. Commanders should consult their SJA on implementing this executive order on a case-by-case basis.

Appendix C

Rules of Engagement

These rules do not limit a commander's inherent authority and obligation to use all necessary means available and to take all appropriate action in self-defense of the commander's unit and other US forces in the vicinity.

CJCSI 3121.01A

Rules of engagement (ROE) are directives issued by competent military authority that delineate the circumstances and limitations under which United States forces will initiate and/or continue combat engagement with other forces encountered (JP 1-02). ROE specify when, where, against whom, and how units can use force. They may be used to control the use of force across the range of Army operations. The aggressiveness that is important in wartime must be tempered with restraint in the ambiguous environment of many stability operations and support operations.

ROE are the commander's rules for the use of force. Commanders must interpret, draft, disseminate, and train rules of engagement. The legal advisor assists the commander to develop ROE, ensuring that the rules do not improperly constrain actions and remain consistent with domestic law, international law, and policies and orders of the chain of command. Clearly stated ROE are published before Army forces are committed. The highest military authority, with input from subordinate commanders, will continually evaluate the ROE and modify them as appropriate.

In general, ROE in wartime differ from ROE in peacetime operations. Wartime ROE reflect the greater necessity to use force. They provide guidelines to prevent civilian casualties and limit collateral damage; however, they permit armed forces to engage all identified enemy targets, regardless of whether those targets represent actual, immediate threats. By contrast, ROE used in many stability operations and support operations merely permit engagement in individual, unit, or national self-defense.

CONTENTS			
Basis of ROE	C-2	Standing Rules of Engagement.....	C-3
Elements of Self Defense	C-2	Interpret, Draft, Disseminate, Train	
Characteristics of Effective ROE.....	C-2	Method.....	C-3

BASIS OF ROE

C-1. ROE provide guidance regarding the use of force by commanders and individuals based on three types of considerations: operational requirements, policy, and law.

C-2. **Operational requirements.** Properly drafted ROE help accomplish the mission by ensuring that the force is used consistently with the overall military objective. They must support both mission accomplishment and force protection. These rules can assist the commander by preventing the unintended start of hostilities or by protecting infrastructure that may prove logistically important. ROE should be distinguished from tactical control measures, threat conditions, and arming orders. Arming orders are sometimes listed on the same cards as ROE for easy reference. Additionally, ROE should be distinguished from other policies and directives, such as weapons confiscation rules.

C-3. **Policy.** ROE reflect the political will of the civilian leadership of the armed forces. Additionally, developing and training ROE to multinational allies is an inherently political process, which may require coordination with the country team or other Department of State representatives.

C-4. **Law.** ROE also reflect domestic and international law. See Appendix B for a synopsis of legal restraints regarding the use of force.

ELEMENTS OF SELF DEFENSE

C-5. Nothing in the ROE can limit the inherent authority and obligation to use all necessary means available and take all appropriate action in self-defense of an individual or a member of Army forces. In all situations, soldiers and commanders use force based on necessity and proportionality:

- **Necessity.** Imminent danger requires a resort to force when there is a hostile act or hostile intent. A “hostile act” is the actual use of armed force—attacking. “Hostile intent” is the threat or imminent use of force.
- **Proportionality.** Force must be limited in intensity, duration, and magnitude to that required to ensure the continued safety of armed forces.

C-6. Graduated response illustrates a technique that clearly incorporates the elements of necessity and proportionality. This technique provides planned responses to an array of hostile and nonhostile threats that the force may encounter. These responses are specifically tailored to the situation and emphasize using minimal necessary force to diffuse the threat. However, graduated response includes the ability to quickly escalate to the level of force required to accomplish the mission.

CHARACTERISTICS OF EFFECTIVE ROE

C-7. Effective ROE conform to the following characteristics:

- **Tactically sound.** ROE should be used to assist in course of action development and selection, but care must be taken to ensure that the mission drives the ROE and not vice-versa.

- **Understandable.** ROE should be unambiguous and written in terms that soldiers can understand.
- **Legally sufficient.** ROE comply with domestic and international laws including the body of law pertaining to armed conflict. Thus, ROE never justify illegal actions.
- **Responsive.** The development, distribution, training, and modification of ROE must be timely and responsive to a changing mission and threat.

STANDING RULES OF ENGAGEMENT

C-8. The joint chiefs of staff have provided the standing rules of engagement (SROE) as baseline guidance for armed forces worldwide. This guidance equally applies to all the combatant commands and can be easily and quickly amended or clarified by mission-specific ROE. See CJCSI 3121.01A for amplification of SROE. SROE apply in the absence of specific guidance from higher authority.

C-9. The SROE provide a common template for developing and implementing ROE across the range of military operations. They include lists of numbered supplemental measures that may be provided by, or requested from, higher authority. The supplemental measures provided in the SROE are intended as a planning tool to tailor ROE for a particular situation. Some examples are—

- Combatant commanders may augment the SROE to respond to the mission and threat in their area of responsibility.
- Joint task force commanders distill SROE and the combatant commander's specific ROE into rules for the unit commander and soldier to apply in the field.
- Commanders at all levels continually review the ROE to ensure their effectiveness in light of current and projected conditions in their area of operations.

C-10. SROE apply to armed forces in support of operations under operational or tactical control of a combatant commander or performing missions under direct control of the president, military departments, or other US government departments or agencies. SROE do not apply to multinational forces or in domestic support operations. AR 190-14 addresses the use of force in domestic support operations.

INTERPRET, DRAFT, DISSEMINATE, TRAIN METHOD

C-11. Commanders and staffs at all echelons use the four facets of the interpret, draft, disseminate, and train methodology to incorporate ROE into the conduct of military operations. FM 1-04 provides doctrine on ROE. The *Operational Law Handbook* and the *ROE Handbook for Judge Advocates* contain additional information on ROE.

C-12. ROE methodology is conducted throughout the military decision making process with the S3, the brigade staff judge advocate (SJA), and staff officers engaged in targeting. The interpretation and drafting of ROE require special attention from the SJA:

- **Interpret.** Operational lawyers are instrumental in interpreting ROE. This may require constant situational understanding by the SJA made possible through his presence at command posts as required.
- **Draft.** In some operations, ROE are *top-driven*, meaning that the higher echelon commander establishes ROE that must be disseminated verbatim to all lower echelons. In contrast, *top-fed* ROE are established for the immediately subordinate echelon. This allows the ROE to be tailored to the particular unit’s situation. When the rules are *top-fed*, commanders and staffs down to brigade level draft ROE for their commands. Figure C-1 contains some of the areas considered in drafting ROE. Figure C-2 shows where ROE information is included in an operation plan or order.

Rules of Engagement Considerations	
<ul style="list-style-type: none"> • International law • Operational concerns (mission requirements) • Commander’s intent • Threat • Tactics and weapons systems organic to the force • Legal requirements (host nation, domestic) • US policy (considering United Nations resolutions and international agreements) 	

Figure C-1. Considerations in Drafting ROE

Where to Find ROE	
Theater and joint task force (JTF) level	Appendix 8 (ROE) to Annex C (Operations) of the operations plan (OPLAN) or operation order (OPORD)
Corps, division, brigade level	Annex E (ROE) to the OPLAN or OPORD

Figure C-2. Where ROE Information is Included in an OPLAN or OPORD

- **Disseminate.** ROE are distributed through the chain of command via a campaign plan, operation plan, or operation order. Additional methods can be used, such as ROE matrices or “ROE conditions” in tactical standing operating procedures. ROE cards are often used to disseminate soldier-relevant rules to the lowest levels. (Figure C-3 beginning on page C-5 shows a ROE card used in operations in Bosnia.) In multinational operations, ROE must be developed in a format that can be promptly distributed to other nations. A coalition support team, if present, can assist in translating, interpreting, distributing, and teaching ROE to multinational forces. All forces must have the same understanding of the ROE.
- **Train.** Soldiers execute in the manner they train; they carry out their tasks in compliance with the ROE when trained to do so. The best training on ROE is situational training. Situational training exercises focus on one or a small group of tasks—within a particular mission

scenario—and require that soldiers practice until the tasks can be executed to the pre-established standard.

Bosnia—SFOR
20 December 1996

NATO UNCLASSIFIED

SFOR—OPERATION CONSTANT GUARD

Commander's Guidance on Use of Force

MISSION

Your mission is to stabilize and consolidate the peace in Bosnia and Herzegovina

SELF-DEFENSE

1. You have the right to use force (including authorized weapons as necessary) in self-defense.
2. Use only the minimum force necessary to defend yourself.

GENERAL RULES

1. Use the minimum force necessary to accomplish your mission.
2. Hostile forces/belligerents who want to surrender will not be harmed. Disarm them and turn them over to your superiors.
3. Treat everyone, including civilians and detained hostile forces/belligerents, humanely.
4. Collect and care for the wounded, whether friend or foe.
5. Respect private property. Do not steal. Do not take "war trophies".
6. Prevent and report all suspect violations of the law of Armed Conflict to superiors.

CHALLENGING AND WARNING SHOTS

1. If the situation permits, issue a challenge:
In English: "SFOR! STOP OR I WILL FIRE!"
or in Serbo-Croat: "SFOR! STANI ILI PUCAM!"
Pronounced as: "SFOR! STANI EEL LEE PUTSAM!")
2. If the person fails to halt, you may be authorized by the on-scene commander or by standing orders to fire a warning shot.

NATO UNCLASSIFIED

Figure C-3. Bosnia Operations ROE Card

NATO UNCLASSIFIED

OPENING FIRE

1. You may open fire only if you, friendly forces, or persons or property under your protection are threatened with deadly force. This means:

You may open fire against an individual who fires or aims his weapon at you, friendly forces, or persons with designated special status under your protection.

You may open fire against an individual who plants, throws, or prepares to throw an explosive or incendiary device at you, friendly forces, or persons with designated special status or property with designated special status under your protection.

You may open fire against an individual who deliberately drives a vehicle at you, friendly forces, persons with a designated special status or property with designated special status under your protection.

2. You may also fire against an individual who attempts to take possession of friendly forces weapons, ammunition, or property with designated special status, and there is no other way of avoiding this.

3. You may use minimum force, including opening fire, against an individual who unlawfully commits, or is about to commit, an act which endangers Life, or is likely to cause serious bodily harm, in circumstances where there is no other way to prevent the act.

MINIMUM FORCE

1. If you have to open fire, you must:

- Fire only aimed shots, and
- Fire no more rounds than necessary, and
- Take all reasonable efforts not to unnecessarily destroy property, and
- Stop firing as soon as the situation permits.

2. You may not intentionally attack civilians or property that is exclusively civilian or religious in character, except if the property is being used for military purpose and engagement is authorized by your commander.

NATO UNCLASSIFIED

Figure C-3. Bosnia Operations ROE Card (continued)

Appendix D

Characteristics of Insurgency

D-1. This appendix follows the discussion in Chapter 3 concerning the nature of insurgency. It provides a basis for analyzing an insurgency by discussing common elements or characteristics. Analyzing these elements helps reveal the insurgency's strengths and weaknesses. This framework can be used whether supporting or opposing the insurgency. Although military planners examine these factors separately, they must understand how the factors interact to fully understand the insurgency. This appendix is a conceptual tool to aid in understanding insurgency; it should be used with the process described in FM 2-91.1.

D-2. Seven elements common to all insurgencies exist: leadership, ideology, objectives, environment and geography, external support, phasing and timing, and organizational and operational patterns. Although they can be examined separately, one must understand how they interact to fully understand the insurgency.

LEADERSHIP

D-3. Insurgency is not simply random political violence; it is directed and focused political violence. It requires leadership to provide vision, direction, guidance, coordination, and organized coherence. Leaders of the insurgency must make their cause known to the people and the government to establish their movement's credibility. They must replace the government's legitimacy with that of their own. Their education, background, family, social connections, and experiences shape how they think and how they will fulfill their goals. These factors also help shape their approach to problem solving.

D-4. Leadership is both a function of organization and personality. Some organizations depend on a charismatic personality to provide cohesion, motivation, and a rallying point for the movement. Organizations led this way can produce decisions and initiate new actions rapidly but are vulnerable to disruptions if key personalities are removed or co-opted. Other organizations de-emphasize individual personalities and provide for redundancy and replacement in decision making. These mechanisms produce collective power and do not depend on specific leaders or personalities to be effective. They are easier to penetrate but more resistant to change. The three types of leaders are—

CONTENTS	
Leadership	D-1
Ideology	D-2
Objectives	D-3
Environment and Geography	D-3
External Support	D-5
Phasing and Timing	D-5
Phase I: Preinsurgency	D-5
Phase II: Organization	D-6
Phase III: Guerilla Warfare	D-6
Phase IV: Conventional Warfare.....	D-6
Phase V: Postinsurgency	D-6
Organizational and Operational Patterns ..	D-6

- **Single person.** The leader may centralize power or decentralize decision making and execution, leaving decision making and execution to subordinates.
- **Single group or party.** The group or party may be headed by a single person or have a ruling council which makes and executes policy. The group or party may also control other groups involved in the insurgency.
- **Group of groups.** Different groups that have different concepts of how the country should be governed make up the leadership. Their single unifying characteristic may be their opposition to the government. They compete with each other as well as with the government.

IDEOLOGY

D-5. To win, the insurgency must have a program that explains society's ills and justifies its insurgent actions. It must promise great improvements after overthrowing the government. The insurgency uses ideology to offer society a goal. The insurgents often express this goal in simple terms for ease of focus. Future plans of the insurgency must be vague enough for broad appeal and specific enough to address important issues.

D-6. The ideology of groups within the movement may indicate differing views of strategic objectives. Groups may have ideological conflicts that they need to resolve before an opponent can capitalize on them. Ideology may suggest objectives and tactics. It greatly influences the insurgent's perception of his environment. This perception of the environment then shapes the movement's organization and operational methods. Some ideologies include—

- **Communism.** Communism advocates state ownership of the means of production and common sharing of labor and products.
- **Socialism.** Socialism (in Marxist theory) is the partial implementation of communism in which the state owns and controls some of the means of production and distribution of capital, land, and other items.
- **Capitalism.** Capitalism is an economic system marked by open competition in a free market in which the means of production and distribution are privately or corporately owned.
- **Religious government.** This government is a system advocating that government and society be structured around a particular set of religious beliefs. It may take many forms including Christianity, Judaism, or Islam.
- **Ethnic nationalism.** This system advocates that the nation be structured around a particular ethnic group.
- **Democracy.** Democracy is a form of government where people exercise control directly or through elected representatives.
- **No clear ideology.** This system has an ideology that is incongruent or not identifiable. It may be purposely vague to allow maximum flexibility. Real ideology may form after the insurgents gain power. In these cases, their single goal may be to rid themselves of the existing government.

OBJECTIVES

D-7. Effective analysis of an insurgency requires interpreting strategic, operational, and tactical objectives. The strategic objective is the insurgent's desired end state; that is, how the insurgent will use the power once he has it. Replacing the government in power is only one step along this path; however, it will likely be the initial focus of efforts. Typically, the strategic objective is critical to cohesion among insurgent groups. It may be the only clearly defined goal the movement presents. The four examples of characterizations of strategic objectives are—

- The revolutionary tries to overthrow the existing power structure.
- The secessionist tries to escape from existing system.
- The restorational tries to return to a “golden age,” restore a previous system of rule, or resist change.
- The reformist tries to change the government policies without its overthrow.

D-8. Objectives can be either operational or tactical. Operational objectives are those that insurgents pursue as part of the overall process of destroying government legitimacy and progressively establishing their desired end state. Tactical objectives are the immediate aims of insurgent acts, such as disseminating psychological operations products or the attack and seizure of a key facility. These actions accomplish tactical objectives that lead to operational goals. Tactical objectives can be psychological as well as physical in nature. For example, legitimacy is the center of gravity for both the insurgents and the counterinsurgents. Legitimacy is largely a product of perception; consequently, it can be the principle consideration in the selection and attainment of tactical objectives.

ENVIRONMENT AND GEOGRAPHY

D-9. Environment and geography, including cultural and demographic factors, affect all participants in a conflict. How insurgents and counterinsurgents adapt to these realities creates advantages and disadvantages for each. The effects of the environment and geography are most visible at the tactical level where the predominant influence on decisions regarding force structure; doctrine; and tactics, techniques, and procedures may exist.

D-10. Civil affairs (CA) forces have a regional focus, coupled with specific cultural awareness, that ensures relevant support to the commander. The G5/S5 and CA staff provide the commander with an area study and assessment (see FM 3-57) that includes—

- Geography, to include physical features, climate, and political geography.
- History.
- People, including demographics, religions, languages, and culture and social structure.
- Host-nation support.
- Legal and administrative systems of the host nation.

D-11. Identifying the significant characteristics of the battlefield environment helps establish the geographical limits of the area of interest and directs the

analytical efforts in steps 2 and 3 of the intelligence preparation of the battlefield (IPB) process. (See Figure D-1.) Defining the area of interest also identifies gaps in the common understanding of the battlefield, serving as a guide to the type of intelligence and information required in refining the IPB process. In defining the area of interest, analysts may examine—

- Strategic location, to include neighboring countries’ boundaries.
- Lines of communications, to include railways, roadways, waterways, pipelines, harbors and ports, and airports.
- Insurgent use of communication systems, to include television stations, telephone systems, cellular phone systems, radio stations, and the Internet.
- Areas and bases used by insurgents for logistics, training, operations, refuge, or illicit drug activities.
- Insurgent operational activities in the area of interest, to include locations for ambushes, roadblocks, kidnappings, sabotage, demonstrations, crimes, meetings, linkup, and surveillance.
- Insurgent support functions in the area of interest, to include logistics routes, cache sites, water sources, fuel storage, and production areas.
- Areas of pro-insurgent population, to include individual villages, cities, and rural areas; areas of insurgent influence; areas of insurgent control; residences of insurgent leadership; and key sympathizers.

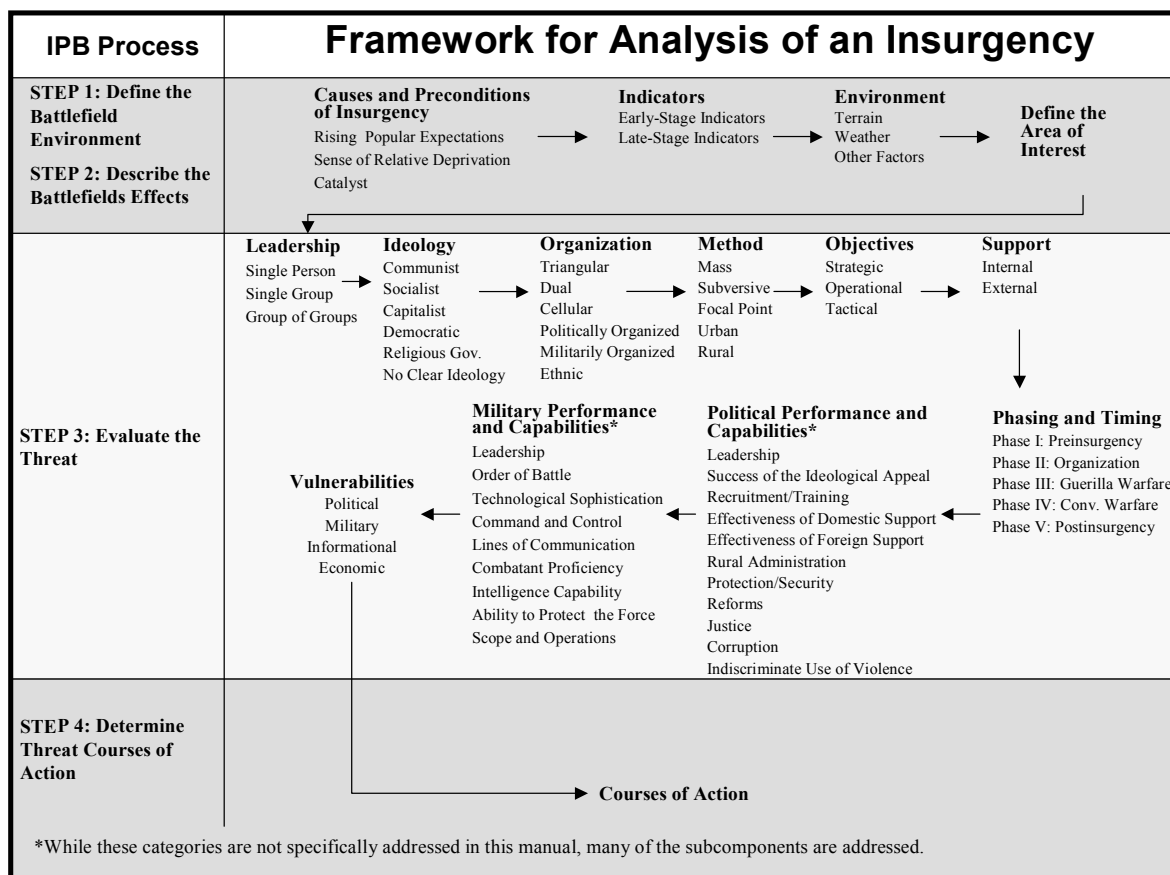

Figure D-1. Integrating the Framework for Analysis During the IPB

EXTERNAL SUPPORT

D-12. Historically, some insurgencies have done well without external support. However, recent examples, such as Vietnam and Nicaragua, show that external support can accelerate events and influence the final outcome. External support can provide political, psychological, and material resources that might otherwise be limited or unavailable. Four main types of external support exist:

- **Moral support** is the acknowledgement of the insurgent as just and admirable.
- **Political support** is the active promotion of insurgents' strategic goals in international forums.
- **Resource support** is the money, weapons, food, advisors, and training.
- **Sanctuary support** is the secure training plus operational and logistic bases.

D-13. Accepting external support can affect the legitimacy of both insurgents and counterinsurgents. It implies the inability to sustain oneself. In addition, the country or group providing support attaches its legitimacy along with the insurgent or the counterinsurgent group it supports. The consequences can affect programs in the supporting nation wholly unrelated to the insurgent situation.

PHASING AND TIMING

D-14. Successful insurgencies pass through common phases of development. Not all insurgencies experience every phase, and progression through all phases is certainly not a requirement for success. The same insurgent movement may be in another phase in other regions of a country. Successful insurgencies can also revert to an earlier phase when under pressure, resuming development when favorable conditions return.

D-15. Some insurgencies depend on proper timing for their success. Because of their limited support, their success depends on weakening the government's legitimacy so that it becomes ineffective. Then, an opportunity to seize power exists. When these insurgencies move to seize power, they expose their organization and intentions. If they move too early or too late, the government may discover their organization and destroy it. The five phases of insurgency are preinsurgency, organization, guerrilla warfare, conventional warfare, and postinsurgency.

PHASE I: PREINSURGENCY

D-16. The characteristics of preinsurgency are—

- Indicators of insurgency are present.
- Preconditions of insurgency are aggravated.
- Leadership emerges in response to domestic grievances or outside influences.
- A catalyst triggers insurgency to organize.

PHASE II: ORGANIZATION

D-17. The characteristics of organization are—

- The insurgency establishes and expands its organization and ideology.
- A popular front is established with other antigovernment groups.
- Antigovernment activity, such as strikes and demonstrations, is initiated.
- Taxation and theft are used to raise funds.
- Education begins of the populace in the insurgency's ideology.
- Small, local guerilla bands are organized; small-scale guerilla activities are begun.
- Terrorism begins to intimidate government officials and hostile members of the population.

PHASE III: GUERRILLA WARFARE

D-18. The characteristics of guerrilla warfare are—

- Increased scale of guerilla attacks.
- Increased use of sabotage and terrorism.
- Propaganda intensifies.
- Insurgents gain control of geographic areas and develop bases for further operations.
- Government officials are driven out of local areas.
- Shadow governments may be established.
- International recognition and support are sought.

PHASE IV: CONVENTIONAL WARFARE

D-19. The characteristics of conventional warfare are—

- Guerilla bands combine to form battalions, regiments, and higher echelons of regular forces.
- More powerful and sophisticated weapons are acquired through foreign assistance or battlefield capture.
- Government forces are challenged directly in battle.
- Areas of insurgent control expand; political activity increases.

PHASE V: POSTINSURGENCY

D-20. The characteristics of postinsurgency are—

- Government is overthrown or it satisfies the insurgent's demands.
- Struggle for political leadership exists between the competing groups.
- New governmental system is established in which the leadership of the insurgency may or may not head.

ORGANIZATIONAL AND OPERATIONAL PATTERNS

D-21. Insurgencies develop organizational and operational patterns from the interaction of many factors. As a result, each insurgency organization is unique. However, knowing the commonly accepted general patterns or strategies of insurgency helps in predicting the tactics and techniques that

may be employed against the supported government. The types of organization are—

- **Triangular.** This organization is composed of three elements: the political party, the popular control mechanism, and the military organization. Leadership of each element is distinct, with the political element in authority.
- **Dual.** A legal overt political party controls the activity of an illegal covert military organization.
- **Cellular.** Small, decentralized groups operate independently of each other. A cellular organization may be combined with any of the other organizational structures to enhance security.
- **Political.** Extensive complex political structure develops before military actions are initiated.
- **Military.** Armed insurgents serve as a catalyst for mobilizing opposition against existing regime.
- **Ethnic.** This organization is organized along ethnic, tribal, or religious lines. It has a perception that government has denied rights of their group.

D-22. Five patterns, or strategies, of insurgency exist—

- **Mass.** This pattern involves a large popular movement, elements of which operate outside the existing system. It involves active and passive popular supporters. It establishes a rival government. Mass uses well-devised ideology and propaganda. It employs regular and guerrilla forces.
- **Focal point.** This pattern's efforts are directed by a small group that uses violence to overturn an existing regime.
- **Subversive.** This pattern uses the political process to place insurgents in positions of authority by election or appointment. The overt element influences public opinion and obstructs the government. The covert element employs terrorism, coercion, and intimidation.
- **Urban.** Insurgents gain control of the cities and move outward. Its efforts focus on disrupting utilities and services, planning mass demonstrations, using overt and covert communication facilities, and discrediting the government. It takes advantage of ease of movement. Urban-based insurgency works best in a centralized society.
- **Rural.** This pattern mobilizes the population of the countryside. The peasant army eventually surrounds the cities, isolates government forces, and brings down the government. Rural-based insurgency works best in a decentralized society.

Appendix E

Negotiations

There are many times when platoon leaders and platoon sergeants at roadblocks, and company and battalion commanders working in cordon and search operations, must negotiate and communicate with potential belligerents. Leaders need to know that they may be placed in a position that requires them to mediate or negotiate on the battlefield.

Brigadier General L. Magruder, III, USA CG, Joint Readiness Training Center

Military leaders can find themselves in the role of a negotiator, mediator, or even arbitrator during operations. Each role requires different attributes; however, this section focuses on those common attributes and techniques necessary for negotiations. Leaders at all levels may conduct negotiations in stability operations and support operations. For example, Army leaders may negotiate for rights of passage; mediate between hostile factions; or barter for use of facilities, buildings, roads, and services. For more information on negotiations, see Chapter 4 of the *JTF Commander's Handbook for Peace Operations*.

CONSIDERATIONS

E-1. Leaders may use the following considerations as a guide to prepare for negotiations; however, there will be a negotiation on the conduct of negotiations. This process must be addressed in your initial planning sessions. No simple answers exist to negotiations and the broader context of conflict management and resolution. The process is complex. What works in one situation may not work in the next. This manual suggests discussing four basic considerations: negotiations do not exist in a vacuum, negotiation is an exercise in persuasion, study alternatives to negotiating an agreement, and be attuned to cultural differences.

CONTENTS	
Considerations	E-0
Negotiations Do Not Exist in a Vacuum	E-1
Negotiation is an Exercise in	
Persuasion	E-1
Study Alternatives to Negotiating an	
Agreement.....	E-1
Be Attuned to Cultural Differences	E-1
Procedures.....	E-1
Establish Communications	E-2
Identify Common Ground on Which to	
Build Dialogue	E-2
Consider Cultural Implications	E-2
Set Clear Goals and Objectives	E-3
Develop a Plan and Diagram the	
Results of Analysis.....	E-3
Determine Composition of Negotiating	
Team and Decision Making	
Mechanisms	E-3
Establish the Venue	E-4
Implementation	E-5
Training.....	E-5

NEGOTIATIONS DO NOT EXIST IN A VACUUM

E-2. Leaders as negotiators must understand the broader issues of conflict and their changing nature. These issues include—

- Maintaining dialogue with all parties, groups, and organizations, to include the government, if one exists, and the opposition, various factions, or militias.
- Preventing any incident to destroy dialogue (even if force is applied); creating an atmosphere of hostility will not lead to a resolution.

NEGOTIATION IS AN EXERCISE IN PERSUASION

E-3. Negotiation is a way to advance interests by jointly decided action. Leaders as negotiators need the cooperation of the other parties. Negotiators must consider them partners in solving the problems.

E-4. Negotiators must think carefully about the full range of interests and prepare thoroughly for the full range of interests of the other parties. They must consider the underlying interests behind a position that a party has taken on a particular issue. People negotiate for different reasons, such as—

- Tasks (the lease of a compound).
- Relationships (to get to know the other party and find out more information about that person).
- Status (legitimacy as participants as others perceive them).

STUDY ALTERNATIVES TO NEGOTIATING AN AGREEMENT

E-5. Leaders as negotiators must consider alternative approaches to determine the most persuasive method to educate others. Negotiators want others to see a negotiated settlement as being in their best interests.

BE ATTUNED TO CULTURAL DIFFERENCES

E-6. Actions can have different connotations to members of other cultures. Culture shapes how people reason, what they accept as fact, and what principles they apply to decision making. Nonverbal behavior such as the symbolic rituals or protocols of the arrangement for a meeting also is important.

E-7. Negotiations can be conducted at several levels: negotiations among United States (US) agencies and departments; between multinational partners; between the military force and United Nations (UN) agencies; and between the military and local leaders. In the joint, combined, and inter-agency environment, negotiations can be complex. Nonetheless, all negotiations require tact, diplomacy, honesty, patience, fairness, effective communications, cross-cultural sensitivity, and careful planning.

PROCEDURES

E-8. This manual suggests that successful negotiations should follow eight steps. Negotiators should establish communications, identify common ground, consider cultural implications, set goals, develop a plan, determine the negotiating team's composition, establish the venue, and then implement the plan.

ESTABLISH COMMUNICATIONS

E-9. Negotiators must establish an effective means of communicating with the political, faction leader, or both. They must not assume that a certain leader or element is opposed to their efforts without careful investigation. Instead, they must ensure that facts are correct before forming any opinions.

IDENTIFY COMMON GROUND ON WHICH TO BUILD DIALOGUE

E-10. Negotiators will spend considerable time determining the exact problem. At this stage, they must focus on the problem rather than the solution. Negotiators may consider certain guidelines:

- Have no expectations. Do not expect a party to negotiate to achieve an agreement if that party perceives more benefits from an alternative to negotiations than to any outcome negotiations could produce. The negotiator needs to persuade the party that negotiations will produce the most benefits.
- Focus on underlying interests. Differences in the relative value of interests, forecasts of future events, aversion to risk, and time preferences may offer opportunities to develop options for mutual gain.
- Learn from the parties. Seek ways through collaboration to find possible alternatives to their present positions.
- When necessary, assume the role of conveyer, facilitator, or mediator. Be patient.

CONSIDER CULTURAL IMPLICATIONS

E-11. There are organizational cultures within the various agencies and departments of the US government as well as the international organizations that shape the context of negotiations. Equally important are national cultural differences. The negotiating team should include experienced interpreters. Their understanding of the cultural context of terms used is invaluable. Negotiators need more than literal translators.

E-12. Negotiation is only one means of resolving conflict. Negotiators should consider indigenous conflict resolution techniques in selecting their approach. Adapting their techniques with indigenous ones may improve the prospects for a settlement. Some implications to consider include—

- Differences. Differences exist in styles of reasoning, the manner in which an individual who carries authority negotiates, and behavior in such dimensions as protocol and time. For example, American culture accepts that one may offer concessions early in a negotiation to reach an agreement. That approach may not have the same connotation in other cultures. Moreover, the concept of compromise, which has a positive connotation for Americans, may have a negative one in other cultures.
- Each side's approach. Americans tend to be direct problem solvers with a give-and-take approach; however, some cultures are indirect, most concerned with the long-term relationships and historical context. Issues of symbolism, status, and face may be important considerations. For example, answers may not be direct and the negotiator will have to look for indirect formulations and nonverbal gestures to understand

what the other party is communicating. In turn, he will need to select his words and gestures with care to avoid communicating unintended meanings.

- Alternate locations. Other cultures may prefer alternate locations for negotiations. In 1993 in Kismayo, Somalia, several clans met to seek political reconciliation in a traditional setting under a tree instead of following the American custom of a meeting at a table.

E-13. If negotiators cannot reach agreement, they must keep the dialogue going. At a minimum, they must seek agreement on when the parties will meet again. They should look for something to keep the momentum alive, going back to earlier discussions on common ground, and seek to keep trust alive in the process.

E-14. From the negotiation team, negotiators often consider selecting one person who understands conflict dynamics and cross-cultural issues to look at the process of the negotiations and give advice. This individual can watch for body language and other indicators of how the process is working. In turn, this person may be able to coach more effective techniques to the negotiators.

SET CLEAR GOALS AND OBJECTIVES

E-15. Negotiators must know what they are trying to accomplish as well as the limits of their authority. They examine how to approach the issues. They settle the easy issues first, often settling issue-by-issue in a predetermined order. Successful negotiators look to create links or to separate unrelated issues. For example, security issues might be separated from logistic issues. They must consider having details worked out at later sessions with the right people and understand that these sessions will also be negotiations.

DEVELOP A PLAN AND DIAGRAM THE RESULTS OF ANALYSIS

E-16. Negotiators should develop a plan and diagram the results of their analyses. Useful questions in this analysis are—

- What are the main issues?
- Who are the relevant parties? First order? Second? Third?
- What are these parties' publicly stated positions? Privately stated positions?
- What are the underlying interests behind these positions?
- What are the important needs of each party?
- What are their concerns? Fears?

DETERMINE COMPOSITION OF NEGOTIATING TEAM AND DECISION MAKING MECHANISMS

E-17. In some cases, the various, interested parties can form a committee or council with appropriate representation. Negotiators should consider several points:

- Identify the right participants in advance. For example, will it include ambassador and joint task force commander-level, mid-level, or working-level personnel?

- Consider the culture when deciding what constitutes the appropriate construct for a meeting. For example, what role do women play in the society? How is *status* defined in the culture?
- Select the composition of the committee or council carefully. It may include legal advisors, political representatives (such as Department of State, UN agencies, or others), military representatives (operations, logistics, civil affairs), and other civilian representatives and non-governmental organizations.
- Ensure that members possess the status and ability to deal with the leadership representing all involved parties.
- For those members seen as part of the military force, ensure that they understand the issues and speak with one voice. This will require a prior negotiation within the negotiator's own delegation. They must understand policy and direction from his higher authority.
- Have patience. Negotiations are time-consuming and can be frustrating. Ensure that the people negotiating can effectively recommend that their superiors ratify an agreement reached. Are all the decision makers who will determine whether the agreement reached is implemented represented in the committee or council?
- Develop a supportive climate. A negotiator creates a supportive climate for the decision makers to complete an agreement. He may find it useful to talk to those who are not decision makers but with those from whom the decision makers will need support. In this way, they may assist the negotiator in helping their decision makers reach agreement.
- Determine the legitimate community leaders. In situations involving severe conflict or state collapse, it may be difficult to determine the legitimate community leaders with whom any lasting agreement must be made.
- Ensure that negotiators understand the scope and latitude of their authority. If feasible, delegate authority to them for negotiation.

ESTABLISH THE VENUE

E-18. Negotiators should consider how meetings are called. Is neutral ground available that is acceptable to all sides? Should US representatives go to the factional leader's location or will this improperly affect the negotiations? Consider details such as the seating arrangements or specific settings traditionally used in the culture. Other concerns for the selection of a negotiating venue may include—

- Security, accessibility, and availability of communications facilities and comfort for all involved parties.
- Sharing relevant information to the negotiations with all parties. The timing of this sharing may vary depending on the circumstances.
- Holding all information generated from the negotiations in confidence until officially released, sharing of information notwithstanding. That decision will depend on the nature of the talks. For example, if publicity may help create support and empower negotiators to agree, release of information may be constructive. Negotiators must be flexible.

IMPLEMENTATION

E-19. At the conclusion of negotiations, negotiators should prepare a report to ensure that they record all accomplishments, agreements, and disagreements for future use. They should also consider giving one person the task of reporting and presenting what has taken place to all participants. This can build trust in the process if each party can view it as an honest effort to understand the other side's position.

TRAINING

E-20. Negotiation and mediation training is essential for military officers in stability operations and many support operations. They need a conceptual foundation in conflict management and resolution. Also necessary are conceptual skills to help them analyze and select approaches to deal with conflicts. Although many leaders develop this skill during the conduct of operations, a predeployment training program is the preferred approach. A course lasting three to five days introduces the basic concepts and then applies the concepts in a series of exercises.

E-21. Ideally, organizations that may participate in peace operations should include education in negotiations as part of the leader professional development. Selected leaders who would benefit from such training include staff officers down to battalion level and company commanders. Such courses are offered at—

- The US Army Peacekeeping Institute in Carlisle Barracks, Pennsylvania. It offers a three and four-day exportable negotiations course.
- The Foreign Service Institute in Arlington, Virginia. It offers a one-week negotiation art and skills course several times a year.

E-22. Other institutions are sources of expertise in negotiation and conflict resolution. These institutions offer training in various formats:

- The US Institute of Peace in Washington, DC, is one of the foremost institutions for its expertise and practical work with governmental and nongovernmental organizations.
- The American Arbitration Association in Washington, DC, provides extensive practical experience to negotiators, mediators, and trainers for governmental agencies and international organizations.
- John F. Kennedy School of Government at Harvard University in Cambridge, Massachusetts, annually offers a one-week course entitled "Strategic Public-Sector Negotiation."
- The Conflict Management Group in Cambridge, Massachusetts, is a nonprofit organization that tailors programs for organizations and has extensive international experience.

Appendix F

Refugees and Displaced Persons

Refugees and displaced persons are a central feature of many stability operations and support operations. Military forces do not have primary responsibility for the international response that assists refugees and displaced persons. However, they may support the activities of their civilian partners. The military may provide security for civilian operations while those operations care for the displaced community. Such security may focus on safety in camps and settlements, the movements of displaced people, the screening of returnees at check points, the protection of relief convoys, and public safety in returnee communities that lack local law and order establishments. The military may also be requested to provide intelligence support to determine the location, timing, movement patterns, and the magnitude of population movements.

ROLE OF THE UNHCR

F-1. The United Nations (UN) Office of the High Commissioner for Refugees (UNHCR) is the lead international organization responsible to protect and assist these refugees and asylum seekers. This office's responsibilities for the protection of refugees include—

- Working to ensure that government authorities identify and provide legal treatment of, access to, and asylum for refugees.
- Assisting with solutions to refugee problems (such as repatriation, integration, and resettlement).
- Supporting returnees.

F-2. To execute its mandate, the UNHCR works with governments; other members of the UN system, such as the World Health Organization and World Food Program; other international organizations, such as the International Organization for Migration; and nongovernmental organizations, such as elements of the International Red Cross and Red Crescent movement.

CONTENTS

Role of the UNHCR	F-0	Nongovernmental Organizations	F-3
US Army Internment and Resettlement		Population Movement	F-4
Operations	F-1	Special Considerations	F-4
Displaced Populations	F-1	Women	F-4
Refugees	F-1	Children and Adolescents	F-4
Internally Displaced Persons	F-2	Elderly	F-5
Responsibilities of States	F-3		

F-3. The UN Office for the Coordination of Humanitarian Affairs (OCHA) and the Interagency Standing Committee (see Appendix A) must ensure that the UN system provides emergency humanitarian assistance to those in need, whether in support of UNHCR or another lead agency.

US ARMY INTERNMENT AND RESETTLEMENT OPERATIONS

F-4. Both stability operations and support operations may require Army forces to conduct internment and resettlement operations. If peace enforcement operations require forcible separation of belligerent parties, then internment/resettlement (I/R) operations must also be conducted as peace enforcement (PE) forces capture or detain parties to the conflict or resettle portions of the population. Depending on the type of conflict that results from forcible separation, I/R operations may need to be conducted for enemy prisoners of war, military detainees, civilian internees or refugees, and dislocated civilians. Without a formal declaration of war, hostile military forces that are captured are categorized as civilian internees and not enemy prisoners of war. The Army is the Department of Defense's (DOD's) executive agent for all civilian internees operations.

F-5. Within the Army, military police units coordinate shelter, protection, accountability, and sustainment for civilian internees. Military police establish forward collection points to relieve other PE forces of the responsibility of handling civilian internees. Working closely with civil affairs, psychological operations units, and intelligence personnel, military police units then evacuate civilian internees to camps where the units provide safe and humane treatment of civilian internees required by international law. I/R operations will become critical as PE forces transition from the PE phase to the peacekeeping phase of peace operations. Civilian internee camps are operated in the same manner as prisoner of war camps, with due regard to the fundamental differences between these two categories. For example, due consideration is given to the age, physical condition, and ability of civilians to adjust to the conditions of internment. Family groups are provided separate quarters when interning more than one member of a family.

DISPLACED POPULATIONS

REFUGEES

F-6. According to the 1951 Convention Relating to the Status of Refugees and its 1967 protocol relating to the status of refugees, a refugee is anyone outside his country of origin "owing to well-founded fear of being persecuted for reasons of race, religion, nationality, membership of a particular social group or political opinion ... and is unable or, owing to such fear, is unwilling to avail himself of the protection of that country; or who, not having a nationality and being outside the country of his former habitual residence as a result of such events, is unable or, owing to such fear, is unwilling to return to it." Since then regional treaties expanded on the convention's basic provisions to include persons compelled to leave their country or persons who flee their country due to civil war, civil unrest, or generalized human rights abuses. These developments have led some countries to modify their laws or practice regarding refugees and asylum, but the United States (US) does not

accept that there have been additions or amendments to the definition of “refugee” spelled out in the convention.

F-7. The most important right detailed in the 1951 convention and its 1967 protocol is that of protection and prohibition against forcible return to the country from which the refugee has fled and to all territories where his life or freedom would be threatened. Article 33 of the convention provides that no state shall expel or return a refugee to territories where his life or freedom is threatened. This prohibition against expelling or returning a refugee is accepted as customary under international law. Such acceptance, in turn, calls on all states to respect the prohibition whether or not the state is a party to the 1951 convention and protocol.

F-8. Paragraph 1 of Article 14 of the Universal Declaration of Human Rights declares that everyone has the right to seek and enjoy asylum. However, paragraph 2 of Article 14 declares that the right is not applicable in cases involving nonpolitical crimes or acts contrary to the purposes and principles of the UN. Violations of the convention’s prohibition against forcible return commonly occur when a prospective refugee is rejected at a frontier where there is no possibility to secure asylum elsewhere. Similarly the convention is violated when the country of asylum expels a refugee to a territory where his security is jeopardized or when the refugee is sent to a country for deportation to his country of origin.

F-9. In addition to the right against forcible return, persons determined to be refugees are entitled to—

- The right to life, liberty, and personal security.
- Freedom from cruel, inhumane torture and punishment.
- Freedom from slavery.
- Freedom of thought, conscience, and religion.
- Freedom from arbitrary arrest and detention and recognition as a person before the law.

INTERNALLY DISPLACED PERSONS

F-10. An *internally displaced person* is any person who has left their residence by reason of real or imagined danger but has not left the territory of their own country (JP 3-07.6). Internally displaced persons (IDPs) are frequently confused with refugees or other displaced persons. The definitions of the two categories of displaced elements of a population in a crisis can get blurred in the area of operations. The distinction between the two categories is essentially a matter of location. A refugee gains that status when he crosses an international border. An IDP, on the other hand, remains within the boundary of the country of origin. What is crucial is that this distinction has less to do with reasons for movement and more to do with technical and legal considerations associated with the individual’s ultimate destination. Both the refugee and the IDP may be fleeing the same threat, and both may experience the same requirements to alleviate the threat. Virtually every humanitarian agency has the flexibility to respond to the needs of both refugees and IDPs. The UNHCR, whose mandate specifically charges the organization to respond to the needs of refugees, can serve the interests of IDPs on a case-by-case basis. Moreover, OCHA must work to ensure that the UN system

protects and assists persons who are not covered by other UN mandates. This office, as the title implies, coordinates the humanitarian response to emergencies and advocates the interests of the internally displaced community.

F-11. A special rapporteur of the UN Commission on Human Rights has published protection principles for IDPs that have gained widespread support. The principles provide direction to the international and local relief communities on issues of internal displacement. The document focuses on IDP basic rights, and the national authorities' responsibilities for protection and assistance. Additionally, the principles include the right of international agencies to offer services to IDPs and the duty of national authorities to assist the return of IDPs to their residences or internal resettlement.

F-12. Military forces have been called on to secure displaced persons within their country of origin. Support for IDPs can take several forms. Often, relief convoys need military security. At times, military forces must insulate internally displaced groups from the population at large. Safe areas may be established to ensure the safety of the targeted group. As with military support to refugee operations, the military forces operate with their civilian partners.

RESPONSIBILITIES OF STATES

F-13. States parties to the 1951 convention or 1967 protocol are obligated to respect the prohibition against forcible return and protect the refugees. Moreover, contracting states may not penalize refugees for illegal entry to the asylum countries since the turmoil surrounding the refugees' departure from the state of origin rarely allows time for proper entry formalities. The convention requires refugees to identify themselves to asylum country authorities as soon as possible and to show cause for the illegal entry.

F-14. Although not required by law, states, especially asylum country neighbors, are further encouraged to collaborate to confront and resolve the cause of the refugee movement and to help protect the population needing asylum. The asylum country bears the greatest refugee burden since moving many people across its border often can produce disruption in the arrival areas.

NONGOVERNMENTAL ORGANIZATIONS

F-15. Nongovernmental organizations (NGOs) are particularly organized and positioned to support refugee operations. NGOs enjoy a greater degree of independence than states and international organizations. They are often the first agencies to provide assistance during an emergency. Additionally, local NGOs are frequently the first to give warning to an emerging crisis. NGOs can use their presence and involvement to protect refugees by reporting concerns, alerting the public and media, promoting international standards, offering advice, and monitoring human rights both within the asylum and original countries. NGOs can provide these services regardless of the agencies' specialties. Those NGOs chartered to work with displaced persons—whether providing material assistance or helping to establish and maintain camps and settlements—are particularly well positioned to monitor and report on refugees, IDPs, and other conditions and treatment.

POPULATION MOVEMENT

F-16. A fundamental point of population movement is that it does not occur without reason. Usually, indicators exist that individual rights are, or soon will be, in jeopardy. Military forces may be requested to provide intelligence support to assist in determining the direction and magnitude of these movements. Any social unrest may lead to detention and armed conflict between individuals and groups.

F-17. There are several stages of movement:

- **Preflight and flight.** Military forces can be called on to provide intelligence support to determine the timing, magnitude, and direction of the population movement. These movements can be alone or en masse.
- **Arrival.** Depending on timing and the security at the arrival location, military forces may be called on to assist international organizations, NGOs, and the host nation during the initial arrival of the refugees. This movement can be alone or in a group.
- **Asylum.** Military forces may secure refugee camps and settlements in the host nation while assisting with stabilization of the refugees' country of origin.
- **Repatriation.** When conditions in the operational area improve and the displaced community returns to its native country, military support may be needed to secure repatriation crossing points, screening points, and transit sites as well as to secure returnee movement to local communities.
- **Reintegration.** Finally, during the final, reintegration phase, military forces may be required to assist with the security of returnees as they are absorbed into their local communities. This support is especially critical in the absence of a capable host-nation public safety establishment. International civilian police normally assume the primary responsibility for community law and order.

SPECIAL CONSIDERATIONS

WOMEN

F-18. Several categories of displaced persons whether refugees or IDPs deserve special consideration. Displaced women and girls have particular protection needs. Effective protection measures require planning, common sense, and specific programs to respond to the needs of this vulnerable group. Special attention to this category is critical because women make up a large number of the displaced community. Practical steps are necessary regarding the security of women in camps and settlements. Among these steps are involving the women in ways to improve their security, ensuring basic services are accessible, and improving lighting.

CHILDREN AND ADOLESCENTS

F-19. Another category of displaced persons that warrants special attention is children and adolescents. Life as a displaced person can be traumatic for children. Displaced youths have many causes for their suffering. Children

often face a myriad of challenges including the persecution of family members, the loss of home and comfortable surroundings, separation from family, the need to assume adult responsibilities, and no time for recreation. The most vulnerable, identified as unaccompanied minors, are the young separated from their parents or caregivers. Refugee children share universal rights with all people, additional rights as children, and particular rights as displaced persons. The US has not ratified the 1989 Convention on the Rights of the Child although virtually all other countries have ratified it. This convention contains provisions that cover refugees under the age of eighteen. It addresses nondiscrimination, social participation, adolescence, and children's relationships with others. Additionally, the UNHCR's policy on refugee children calls for reunifying children with primary caregivers as quickly as possible.

ELDERLY

F-20. The elderly also deserve special attention. Depending on the geography of the crisis, the age of this category of refugee could vary from mid-forties to late-seventies. Regardless of age, the elderly displaced persons share reduced opportunity for training and employment, a lack of information on rights and services to which they are entitled, and the risk of abandonment by families unable to provide care. Typically, most elderly refugees become dependent on others only during the final stages of disability and illness. The main problem with the elderly in a refugee situation is that the forced displacement denies them the chance to be provided for by others in the manner to which they are accustomed. Significantly, just as with displaced children, the elderly become most vulnerable when forcibly separated from their families. Separation can occur during any stage of the displaced community experience. During preflight and flight, the younger members of the community are frequently killed. Their deaths leave the elderly behind or moving without support. During asylum or resettlement, younger members often leave first in search of greater security or employment. During repatriation, often after extended asylum, the young are more apt to lose touch with, and interest in, the country of origin, thus leaving the elderly to return alone. This abandonment results in an older group of displaced persons with no source of assistance leading to long-term dependency on the relief mission.

Glossary

AC-130	US Air Force gunship
admin	administration (graphics)
AF	Air Force
AMD	air and missile defense
antiterrorism	defensive measures used to reduce the vulnerability of individuals and property to terrorist acts, to include limited response and containment by local military forces (JP 1-02)
AO	area of operations
AOR	area of responsibility
AOS	area of separation
AR	Army Regulation
ARNG	Army National Guard
area of operations	An operational area defined by the joint force commander for land and naval forces. Areas of operation do not typically encompass the entire operational area of the joint force commander, but should be large enough for component commanders to accomplish their missions and protect their forces. (JP 5-0)
area of separation	<i>see</i> buffer zone (JP 3-07.3)
arms control	a concept that denotes on some occasions those measures taken for the purpose of reducing instability in the military environment (JP 1-02)
ARSOF	Army special operations forces
AT	antiterrorism
AUTL	Army Universal Task List
battle handover	A designated point (phase line) on the ground where responsibility transitions from the stationary force to the moving force and vice versa. It is within direct fire range and observed indirect fire range of the stationary force. (FM 1-02)
buffer zone	A defined area controlled by a peace operations force from which disputing or belligerent forces have been excluded. A buffer zone is formed to create an area of separation between disputing or belligerent forces and reduce the risk of renewed conflict. (JP 3-07.3)
BZ	buffer zone
C2	command and control

C4	command, control, communications, and computer (graphics)
CA	civil affairs
CAARNG	California Army National Guard
CBRNE	chemical, biological, radiological, nuclear, and high-yield explosive
CBT	combatting terrorism
CD	counterdrug
CDRG	catastrophic disaster response group
CG	commanding general
CI	counterintelligence
CIA	Central Intelligence Agency
CIMIC	civil-military cooperation
civil administration	an administration established by a foreign government in (1) friendly territory, under an agreement with the government of the area concerned, to exercise certain authority normally the function of the local government; or (2) hostile territory, occupied by United States forces, where a foreign government exercises executive, legislative, and judicial authority until an indigenous civil government can be established (JP 3-57)
civil affairs	designated Active and Reserve component forces and units organized, trained, and equipped specifically to conduct civil affairs activities and to support civil-military operations (JP 3-57)
civil disturbance	group acts of violence and disorder prejudicial to public law and order (JP 1-02)
civil-military operations	The activities of a commander that establish, maintain, influence, or exploit relations between military forces, governmental and nongovernmental civilian organizations and authorities, and the civilian populace in a friendly, neutral, or hostile operational area in order to facilitate military operations, to consolidate and achieve operational US objectives. Civil-military operations may include performance by military forces of activities and functions normally the responsibility of the local, regional, or national government. These activities may occur prior to, during, or subsequent to other military actions. They may also occur, if directed, in the absence of other military operations. Civil-military operations may be performed by designated civil affairs, by other military forces, or by a combination of civil affairs and other forces. (JP 3-57)
CJCS	Chairman of the Joint Chiefs of Staff
CJCSI	Chairman of the Joint Chiefs of Staff Instruction
CMO	civil-military operations
CMOC	civil-military operations center

COM	chief of mission
combat service support	The essential capabilities, functions, activities, and tasks necessary to sustain all elements of operating forces in theater at all levels of war. Within the national and theater logistic systems, it includes but is not limited to that support rendered by service forces in ensuring the aspects of supply, maintenance, transportation, health services, and other services required by aviation and ground combat troops to permit those units to accomplish their missions in combat. Combat service support encompasses those activities at all levels of war that produce sustainment to all operating forces on the battlefield. (Army) - CSS also include those activities in stability and support operations that sustain all operating forces. The included branches and functions are: Adjutant General Corps, Acquisition Corps, Chaplain Corps, Finance Corps, Judge Advocate General Corps, Medical Corps, Ordnance Corps, Transportation Corps, and the Quartermaster Corps. (FM 1-02)
combatant command	A unified or specified command with a broad continuing mission under a single commander established and so designated by the President, through the Secretary of Defense and with the advice and assistance of the Chairman of the Chiefs of Staff. Combatant commands typically have geographic or functional responsibilities. (JP 5-0)
combatant commander	a commander in chief of one of the unified or specified combatant commands established by the President (JP 0-2)
combatting terrorism	actions, including antiterrorism (defensive measures taken to reduce vulnerability to terrorist acts) and counterterrorism (offensive measures taken to prevent, deter, and respond to terrorism), taken to oppose terrorism throughout the entire threat spectrum (JP 1-02)
command and control	(Army) the exercise of authority and direction by a properly designated commander over assigned and attached forces in the accomplishment of the mission. Commanders perform command and control functions through a command and control system. (FM 6-0)
commander's critical information requirements	elements of information required by commanders that directly affect decision making and dictate the successful execution of military operations (FM 3-0)
common operational picture	an operational picture tailored to the user's requirements, based on common data and information shared by more than one command (FM 3-0)
complex contingency operations	large-scale peace operations (or elements thereof) conducted by a combination of military forces and nonmilitary organizations that combine one or more of the elements of peace operations which include one or more elements of other types of operations such as foreign humanitarian assistance, nation

	assistance, support to insurgency, or support to counterinsurgency (JP 3-57)
consequence management	Those measures taken to protect public health and safety, restore essential government services, and provide emergency relief to governments, businesses, and individuals affected by the consequences of a chemical, biological, nuclear, and/or high-yield explosive situation. For domestic consequence management, the primary authority rests with the States to respond and the Federal Government to provide assistance required. (JP 3-0)
CONUS	continental United States
CONUSA	Continental United States army
Conv.	Conventional (graphics)
CORDS	Civil Operations Revolutionary Development Support
counterdrug operations	civil or military actions taken to reduce or eliminate illicit drug trafficking (JP 3-07.4)
counterdrug	those active measures taken to detect, monitor, and counter the production, trafficking, and use of illegal drugs (JP 3-05)
counterinsurgency	those military, paramilitary, political, economic, psychological, and civic actions taken by a government to defeat insurgency (JP 1-02)
counterintelligence	information gathered and activities conducted to protect against espionage, other intelligence activities, sabotage, or assassinations conducted by or on behalf of foreign governments or elements thereof, foreign organizations, or foreign persons, or international terrorist activities (JP 1-02)
countermobility operations	The construction of obstacles and emplacement of minefields to delay, disrupt, and destroy the enemy by reinforcement of the terrain. The primary purpose of countermobility operations is to slow or divert the enemy, to increase time for target acquisition, and to increase weapons effectiveness. (JP 1-02)
crisis management	Measure to resolve a hostile situation and investigate and prepare a criminal case for prosecution under federal law. Crisis management will include a response to an incident involving a weapon of mass destruction, special improvised explosive device, or a hostage crisis that is beyond the capability of the lead federal agency. (JP 3-07.6)
CS	combat support
CSS	combat service support
CT	counterterrorism
ctr	counter (graphics)
D&M	detection and monitoring
DA	Department of the Army

DAO	Defense Attaché Office
DART	disaster assistance response team
DC	District of Columbia
DCM	deputy chief of mission
DCO	defense coordinating officer
DEA	Drug Enforcement Administration
decisive operations	Those operations that directly accomplish the task assigned by the higher headquarters. Decisive operations conclusively determine the outcome of major operations, battles, and engagements. (FM 3-0)
decon	decontamination (graphics)
defensive information operations	(Army) The integration and coordination of policies and procedures, operations, personnel, and technology to protect and defend friendly information and information systems. Defensive information operations ensure timely, accurate, and relevant information access while denying adversaries the opportunity to exploit friendly information and information systems for their own purposes. (FM 3-0)
demobilization	the process of transitioning a conflict or wartime military establishment and defense-based civilian economy to a peacetime configuration while maintaining national security and economic vitality (JP 4-05)
deployment	(Army) those activities required to prepare and move a force and its sustainment equipment and supplies to the area of operations in response to a crisis or natural disaster (FM 3-35)
DHHS	Department of Health and Human Services
dir	director (graphics)
DMZ	demilitarized zone
DOD	Department of Defense
DODD	Department of Defense Directive
domestic emergencies	emergencies affecting the public welfare and occurring within the 50 states, District of Columbia, Commonwealth of Puerto Rico, US possessions and territories, or any political subdivision thereof, as a result of enemy attack, insurrection, civil disturbance, earthquake, fire, flood, or other public disasters or equivalent emergencies that endanger life and property or disrupt the usual process of government (JP 1-02)
domestic support operations	those activities and measures taken by the Department of Defense to foster mutual assistance and support between the Department of Defense and any civil government agency in planning or preparedness for, or in the application of resources

	for response to, the consequences of civil emergencies or attacks, including national security emergencies (JP 3-57)
DOMS	Director of Military Support
DOS	Department of State
DSO	domestic support operations
EAC	emergency action committee
EAP	Emergency Action Plan
ECC	evacuation control center
electronic warfare	any military action involving the use of electromagnetic and directed energy to control the electromagnetic spectrum or to attack the enemy (JP 3-51)
employment	the strategic, operational, or tactical use of forces (JP 5-0)
EO	executive order
EOD	explosive ordnance disposal
ESF	emergency support function
essential elements of friendly information	(Army) the critical aspects of a friendly operation that, if known by the enemy, would subsequently compromise, lead to failure, or limit success of the operation, and therefore must be protected from enemy detection (FM 3-13)
EST	emergency support team (FEMA)
FAA	Foreign Assistance Act
FBI	Federal Bureau of Investigation
FCO	federal coordinating officer (USG)
FEMA	Federal Emergency Management Agency
FHA	foreign humanitarian assistance
FID	foreign internal defense
FM	field manual
FMFP	foreign military financing program
force protection	Actions taken to prevent or mitigate hostile actions against Department of Defense personnel (to include family members), resources, facilities, and critical information. These actions conserve the force's fighting potential so it can be applied at the decisive time and place and incorporate the coordinated and synchronized offensive and defensive measures to enable the effective employment of the joint force while degrading opportunities for the enemy. Force protection does not include actions to defeat the enemy or protect against accidents, weather, or disease. (JP 3-0)
force tailoring	the process of determining the right mix and sequence of units for a mission (FM 3-0)

foreign disaster relief	Prompt aid that can be used to alleviate the suffering of foreign disaster victims. Normally it includes humanitarian services and transportation; the provision of food, clothing, medicine, beds, and bedding; temporary shelter and housing; the furnishing of medical materiel and medical and technical personnel; and making repairs to essential services. (JP 3-07.6)
foreign humanitarian assistance	Programs conducted to relieve or reduce the results of natural or manmade disasters or other endemic conditions such as human pain, disease, hunger, or privation that might present a serious threat to life or that can result in great damage to or loss of property. Foreign humanitarian assistance (FHA) provided by US forces is limited in scope and duration. The foreign assistance provided is designed to supplement or complement the efforts of the host nation civil authorities or agencies that may have the primary responsibility for providing FHA. FHA operations are those conducted outside the United States, its territories, and possessions. (JP 3-07.6)
foreign internal defense	participation by civilian and military agencies of a government in any of the action programs taken by another government to free and protect its society from subversion, lawlessness, and insurgency (JP 1-02)
FRP	Federal Response Plan
full spectrum operations	the range of operation Army forces conduct in war and military operations other than war (FM 3-0)
FWF	former warring factions
FY	fiscal year
G2	intelligence staff officer
G5	assistant chief of staff
gov.	government (graphics)
guerilla warfare	military and paramilitary operations conducted in enemy-held or hostile territory by irregular, predominantly indigenous forces (JP 1-02)
HCA	humanitarian and civic assistance
HDO	humanitarian demining operations
HN	host nation
HOC	humanitarian operations center
host nation	a nation that receives the forces and/or supplies of allied nations, coalition partners, and/or NATO organizations to be located on, to operate in, or to transit through its territory (JP 1-02)
human intelligence	a category of intelligence derived from information collected and provided by human sources (JP 1-02)

humanitarian and civic assistance	Assistance to the local populace provided by predominantly US forces in conjunction with military operations and exercises. This assistance is specifically authorized by title 10, United States Code, section 401, and funded under separate authorities. Assistance provided under these provisions is limited to (1) medical, dental, and veterinary care provided in rural areas of a country; (2) construction of rudimentary surface transportation systems; (3) well drilling and construction of basic sanitation facilities; and (4) rudimentary construction and repair of public facilities. Assistance must fulfill unit training requirements that incidentally create humanitarian benefit to the local populace. (JP 3-05.3)
HUMINT	human intelligence
I/R	internment/resettlement
ICRC	International Committee of the Red Cross
IDAD	internal defense and development
IDP	internally displaced person
IFOR	NATO Implementation Force (Bosnia)
information environment	the aggregate of individuals, organizations, or systems that collect, process, or disseminate information; also included is the information itself (JP 3-13)
information management	The provision of relevant information to the right person at the right time in a usable form to facilitate situational understanding and decision making. It uses procedures and information systems to collect, process, store, display, and disseminate information. (FM 3-0)
information operations	(Army) actions taken to affect adversary, and influence others', decision making processes, information and information systems while protecting one's own information and information systems (FM 3-0)
information superiority	(Army) the operational advantage derived from the ability to collect, process, and disseminate an uninterrupted flow of information while exploiting or denying an adversary's ability to do the same (FM 3-0)
insurgency	an organized movement aimed at the overthrow of a constituted government through use of subversion and armed conflict (JP 1-02)
integration	(1) In force protection, the synchronized transfer of units into an operational commander's force prior to mission execution. (2) The arrangement of military forces and their actions to create a force that operates by engaging as a whole. (JP 0-2)
intelligence	(1) The product resulting from the collection, processing, integration, analysis, evaluation, and interpretation of available information concerning foreign countries or areas. (2) Information and

	knowledge about an adversary obtained through observation, investigation, analysis, or understanding. (JP 2-0)
intermediate staging base	a temporary location used to stage forces prior to inserting the forces into the host nation (JP 3-07.5)
internal defense and development	the full range of measures taken by a nation to promote its growth and protect itself from subversion, lawlessness, and insurgency. It focuses on building viable institutions (political, economic, social, and military) that respond to the needs of society (JP 1-02)
internally displaced person	any person who has left their residence by reason of real or imagined danger but has not left the territory of their own country (JP 3-07.6)
IO	information operations
IPB	intelligence preparation of the battlefield
ISR	intelligence, surveillance, and reconnaissance
JAG	judge advocate general
JCS	Joint Chiefs of Staff
JTF	joint task force
JTF-CS	Joint Task Force–Civil Support
JTF-KU	Joint Task Force–Kuwait
JTF-LA	Joint Task Force–Los Angeles
KFOR	Kosovo forces
L.A.	Los Angeles (California) (graphics)
law of war	that part of international law that regulates the conduct of armed hostilities (JP 1-02)
LEA	law enforcement agency
lead agency	Designated among US Government agencies to coordinate the interagency oversight of the day-to-day conduct of an ongoing operation. The lead agency is to chair the interagency working group established to coordinate policy related to a particular operation. The lead agency determines the agenda, ensures cohesion among the agencies, and is responsible for implementing decisions. (JP 3-08)
LFA	lead federal agency
line of communications	a route, either land, water, and/or air, that connects an operating military force with a base of operations and along which supplies and military forces move (JP 1-02)
LNO	liaison officer
LOC	line of communications
LOGCAP	logistics civilian augmentation program

MCA	military civic action
MDMP	military decision making process
measures of effectiveness	Tools used to measure results achieved in the overall mission and execution of assigned tasks. Measures of effectiveness are a prerequisite to the performance of combat assessment. (JP 3-60)
METL	mission essential task list
METT-TC	mission, enemy, terrain and weather, troops and support available, time available, civil considerations
MFO	multinational force and observers (graphics)
military operations other than war	Operations that encompass the use of military capabilities across the range of military operations short of war. These military actions can be applied to complement any combination of the other instruments of national power and occur before, during, and after war. (JP 3-07)
MILOB	military observer
mobility	a quality or capability of military forces which permits them to move from place to place while retaining the ability to fulfill their primary mission (JP 1-02)
MOOTW	military operations other than war
MOU	memorandum of understanding
MP	military police
MSCA	military support to civil authorities
MSD	Mobile Security Division
MSG	Marine Security Guard
NATO	North Atlantic Treaty Organization
NBC	nuclear, biological, and chemical
negotiations	a discussion between authorities and a barricaded offender or terrorist to effect hostage release and terrorist surrender (JP 3-07.2)
NEO	noncombatant evacuation operation
NG	National Guard
NGO	nongovernmental organization
NICI	National Interagency Civil-Military Institute
NMS	national military strategy
noncombatant evacuation operations	Operations directed by the Department of State, the Department of Defense, or other appropriate authority whereby noncombatants are evacuated from foreign countries when their lives are endangered by war, civil unrest, or natural disaster to safe havens or to the United States (JP 3-07)

nongovernmental organizations Transnational organizations of private citizens that maintain a consultative status with the Economic and Social Council of the United Nations. Nongovernmental organizations may be professional associations, foundations, multinational businesses, or simply groups with a common interest in humanitarian assistance activities (development and relief). “Nongovernmental organizations” is a term normally used by non-United States organizations. (JP 1-06)

NSC National Security Council

NSS national security strategy

OAKOC observation and fields of fire, avenues of approach, key terrain, obstacles and movement, and cover and concealment

OCHA UN Office for the Coordination of Humanitarian Affairs

OES office of emergency services

offensive information operations (Army) are the integrated use of assigned and supporting capabilities and activities, mutually supported by intelligence, to affect enemy decision makers or to influence others to achieve or promote specific objectives (FM 3-0)

OP observation post

OPCON operational control

operational control Command authority that may be exercised by commanders at any echelon at or below the level of combatant command. Operational control is inherent in combatant command (command authority) and may be delegated within the command. When forces are transferred between combatant commands, the command relationship the gaining commander will exercise (and the losing commander will relinquish) over these forces must be specified by the Secretary of Defense. Operational control is the authority to perform those functions of command over subordinate forces involving organizing and employing commands and forces, assigning tasks, designating objectives, and giving authoritative direction necessary to accomplish the mission. Operational control includes authoritative direction over all aspects of military operations and joint training necessary to accomplish missions assigned to the command. Operational control should be exercised through the commanders of subordinate organizations. Normally this authority is exercised through subordinate joint force commanders and Service and/or functional component commanders. Operational control normally provides full authority to organize commands and forces and to employ those forces as the commander in operational control considers necessary to accomplish assigned missions; it does not, in and of itself, include authoritative direction for logistics or matters of administration, discipline, internal organization, or unit training. (JP 0-2)

operations security a process of identifying critical information and subsequently analyzing friendly actions attendant to military operations and

other activities to: a. identify those actions that can be observed by adversary intelligence systems; b. determine indicators that hostile intelligence systems might obtain that could be interpreted or pieced together to derive critical information in time to be useful to adversaries; and c. select and execute measures that eliminate or reduce to an acceptable level the vulnerabilities of friendly actions to adversary exploitation (JP 3-07.2)

OPLAN	operation plan
OPNS	operations (graphics)
OPORD	operation order
OPSEC	operations security
OSOCC	on-site operations coordination center
PA	public affairs
PAM	pamphlet
PAO	public affairs officer
PDD	Presidential Decision Directive
PE	peace enforcement
peace building	post-conflict actions, predominantly diplomatic and economic, that strengthen and rebuild governmental infrastructure and institutions in order to avoid a relapse into conflict (JP 3-07)
peace enforcement	application of military force, or the threat of its use, normally pursuant to international authorization, to compel compliance with resolutions or sanctions designed to maintain or restore peace and order (JP 3-07)
peace operations	a broad term that encompasses peacekeeping operations and peace enforcement operations conducted in support of diplomatic efforts to establish and maintain peace (JP 3-07)
peacekeeping	military operations undertaken with the consent of all major parties to a dispute, designed to monitor and facilitate implementation of an agreement (ceasefire, truce, or other such agreement) and support diplomatic efforts to reach a long-term political settlement (JP 3-07)
peacemaking	the process of diplomacy, mediation, negotiation, or other forms of peaceful settlements that arranges an end to a dispute and resolves issues that led to it (JP 3-07)
peacetime military engagement	encompasses all military activities that involve other nations and are intended to shape the security environment in peacetime. It includes programs and exercises that the US military conducts with other nations to shape the international environment, improve mutual understanding with other countries, and improve interoperability with treaty partners or potential coalition partners. Peacetime military engagement

	activities are designed to support a combatant commander's objectives as articulated in the theater engagement plan. (FM 3-0)
PEO	peace enforcement operations
PEP	personnel exchange program
PIR	priority intelligence requirements
PK	peacekeeping
PKO	peacekeeping operations
planning	the means by which the commander envisions a desired outcome, lays out effective ways of achieving it, and communicates to his subordinates his vision, intent, and decisions, focusing on the results he expects to achieve (FM 3-0)
PO	peace operations
POLAD	political advisor
Pol-Mil	political-military
preventive deployment	The deployment of military forces to deter violence at the interface or zone of potential conflict where tension is rising among parties. Forces may be employed in such a way that they are indistinguishable from a peacekeeping force in terms of equipment, force posture, and activities. (JP 3-07)
preventive diplomacy	diplomatic actions taken in advance of a predictable crisis to prevent or limit violence (JP 3-07)
priority intelligence requirements	those intelligence requirements for which a commander has an anticipated and stated priority in the task of planning and decision making (JP 2-0)
propaganda	any form of communication in support of national objectives designed to influence the opinions, emotions, attitudes, or behavior of any group in order to benefit the sponsor, either directly or indirectly (JP 1-02)
PSO	post security officer
psychological operations	Planned operations to convey selected information and indicators to foreign audiences to influence their emotions, motives, objective reasoning, and ultimately the behavior of foreign governments, organizations, groups, and individuals. The purpose of psychological operations is to induce or reinforce foreign attitudes and behavior favorable to the originator's objectives. (JP 1-02)
PSYOP	psychological operations
reconnaissance	a mission undertaken to obtain, by visual observation or other detection methods, information about the activities and resources of an enemy or potential enemy, or to secure data concerning the meteorological, hydrographic, or geographic characteristics of a particular area (JP 1-02)

refugee	a person who, by reason of real or imagined danger, has left their home country or country of their nationality and is unwilling or unable to return (JP 3-07.6)
ROE	rules of engagement
ROTC	Reserve Officer Training Corps
RSO	regional security officer
RTF	response task force
rules of engagement	directives issued by competent military authority that delineate the circumstances and limitations under which United States forces will initiate and/or continue combat engagement with other forces encountered (JP 1-02)
S3	operations officer
S5	civil affairs officer (US Army)
SA	security assistance
sabotage	An act or acts with intent to injure, interfere with, or obstruct the national defense of a country by willfully injuring or destroying, or attempting to injure or destroy, any national defense or war materiel, premises, or utilities, to include human and natural resources (JP 1-02)
safe haven	designated area(s) to which noncombatants of the United States Government's responsibility and commercial vehicles and materiel may be evacuated during a domestic or other valid emergency (JP 4-01.6)
SAO	security assistance organization
SCO	state coordinating officer
SCRAG	senior civilian representative of the attorney general
security assistance organization	All Department of Defense elements located in a foreign country with assigned responsibilities for carrying out security assistance management functions. It includes military assistance advisory groups, military missions and groups, offices of defense and military cooperation, liaison groups, and defense attaché personnel designated to perform security assistance functions. (JP 3-07.1)
security assistance	group of programs authorized by the Foreign Assistance Act of 1961, as amended, and the Arms Export Control Act of 1976, as amended, or other related statutes by which the United States provides defense articles, military training, and other defense-related services by grant, loan, credit, or cash sales in furtherance of national policies and objectives (JP 1-02)
SFOR	NATO Stabilization Force (Bosnia)
shaping operations	at any echelon create and preserve conditions for the success of the decisive operation (FM 3-0)

show of force	an operation designed to demonstrate US resolve that involves increased visibility of US deployed forces in an attempt to defuse a specific situation that, if allowed to continue, may be detrimental to US interests or national objectives (JP 3-07)
situational understanding	the product of applying analysis and judgment to the common operational picture to determine the relationships among the factors of METT-TC (FM 3-0)
SJA	staff judge advocate
SOFA	status-of-forces agreement
split-based operation	the dividing of logistics, staff, and management and command functions so that only those functions absolutely necessary are deployed, allowing some logistics, staff, and management and command functions to be accomplished from CONUS or another theater (FM 3-93)
SROE	standing rules of engagement
stability operations	promote and protect US national interests by influencing the threat, political, and information dimensions of the operational environment through a combination of peacetime developmental, cooperative activities and coercive actions in response to crisis (FM 3-0)
STANAG	standardization agreement
STARC	state area command
Stat.	<i>Statutes at Large</i>
subversion	action designed to undermine the military, economic, psychological, or political strength or morale of a regime (JP 1-02)
support operations	employ Army forces to assist civil authorities, foreign or domestic, as they prepare for or respond to crisis and relieve suffering (FM 3-0)
surveillance	the systematic observation of aerospace, surface, or subsurface areas, places, persons, or things, by visual, aural, electronic, photographic, or other means. See also air surveillance; satellite and missile surveillance; sea surveillance (JP 1-02)
survivability	Concept which includes all aspects of protecting personnel, weapons, and supplies while simultaneously deceiving the enemy. Survivability tactics include building a good defense; employing frequent movement; using concealment, deception, and camouflage; and constructing fighting and protective positions for both individuals and equipment. (JP 3-34)
sustaining operations	are operations at any echelon that enable shaping and decisive operations by providing combat service support, rear area and base security, movement control, terrain management, and infrastructure development (FM 3-0)
SYG	Secretary General (UN)

synchronization	arranging activities in time, space, and purpose to mass maximum relative combat power at a decisive place and time (FM 3-0)
TACAIR	tactical air
TBP	to be published
terrorism	the calculated use of unlawful violence or threat of unlawful violence to inculcate fear; intended to coerce or to intimidate governments or societies in the pursuit of goals that are generally political, religious, or ideological (JP 3-07.2)
time-phased force and deployment data	The Joint Operation Planning and Execution System database portion of an operation plan; it contains time-phased force data, non-unit-related cargo and personnel data, and movement data for the operation plan, including the following: a. In-place units; b. Units to be deployed to support the operation plan with a priority indicating the desired sequence for their arrival at the port of debarkation; c. Routing of forces to be deployed; d. Movement data associated with deploying forces; e. Estimates of non-unit-related cargo and personnel movements to be conducted concurrently with the deployment of forces; and f. Estimate of transportation requirements that must be fulfilled by common-user lift resources as well as those requirements that can be fulfilled by assigned or attached transportation resources. (JP 5-0)
TOR	terms of reference
TPFDD	time-phased force and deployment data
TRADOC	US Army Training and Doctrine Command
trans	transportation (graphics)
TTP	tactics, techniques, and procedures
U2	a single seat, single-engine, high-altitude, surveillance and reconnaissance aircraft used by the Air Force
UCMJ	Uniform Code of Military Justice
UN	United Nations
unconventional assisted recovery	evader recovery conducted by directed unconventional warfare forces, dedicated extraction teams, and/or unconventional assisted recovery mechanisms operated by guerrilla groups or other clandestine organizations to seek out, contact, authenticate, support, and return evaders to friendly control (JP 3-50.3)
unconventional warfare	A broad spectrum of military and paramilitary operations, normally of long duration, predominantly conducted by indigenous or surrogate forces who are organized, trained, equipped, supported, and directed in varying degrees by an external source. It includes guerrilla warfare and other direct offensive, low visibility, covert, or clandestine operations, as well as the indirect

activities of subversion, sabotage, intelligence activities, and evasion and escape. (JP 3-05.5)

UNDPKO United Nations Department of Peacekeeping Operations

unexploded explosive ordnance explosive ordnance which has been primed, fused, armed or otherwise prepared for action, and which has been fired, dropped, launched, projected, or placed in such a manner as to constitute a hazard to operations, installations, personnel, or material and remains unexploded either by malfunction or design or for any other cause (JP 1-02)

UNHCR United Nations Office of the High Commissioner for Refugees

UNMIK-P United Nations Mission in Kosovo–Police

UNOSOM United Nations Operations in Somalia

US person a United States citizen, an alien known by the intelligence agency concerned to be a permanent resident alien, an unincorporated association substantially composed of United States citizens or permanent resident aliens, or a corporation incorporated in the United States, except for a corporation directed and controlled by a foreign government or governments.

US United States

USA United States Army

USAID United States Agency for International Development

USC United States Code

USDR US Defense Representative

USG US government

weapon systems a combination of one or more weapons with all related equipment, materials, services, personnel, and means of delivery and deployment (if applicable) required for self-sufficiency (JP 1-02)

weapons of mass destruction Weapons that are capable of a high order of destruction and/or of being used in such a manner as to destroy large numbers of people. Weapons of mass destruction can be high explosives or nuclear, biological, chemical, and radiological weapons, but exclude the means of transporting or propelling the weapon where such means is a separable and divisible part of the weapon. (JP 1-02)

WMD weapons of mass destruction

WMD-CST WMD civil support teams

WPR War Powers Resolution

Bibliography

The bibliography lists field manuals by new number followed by old number.

DOCUMENTS NEEDED

These documents must be available to the intended users of this publication.

JP 1-02. *Department of Defense Dictionary of Military and Associated Terms*. Available [Online] at <http://www.dtic.mil/doctrine/jel/doddict/>

FM 1-02 (101-5-1). *Operational Terms and Graphics*. 30 September 1997.

READINGS RECOMMENDED

These sources contain relevant supplemental information.

JOINT PUBLICATIONS

Most Joint Publications are available [online] at <http://www.dtic.mil/doctrine/>

(S) CJCSI 3121.01A. *Standing Rules of Engagement for US Forces (U)*. 15 January 2000. Found in Appendix A of the *Rules of Engagement (ROE) Handbook for Judge Advocates*. 01 May 2000. Available [Online] at <http://www.jagcnet.army.mil/CLAMO>

CJCSI 3214.01. *Military Support to Foreign Consequence Management Operations*. 30 June 1998.

CJCSI 5810.01B. *Implementation of the DOD Law of War Program*. 25 March 2002.

Joint Strategic Capabilities Plan

JP 3-0. *Doctrine for Joint Operations*. 10 September 2001.

JP 3-07. *Joint Doctrine for Military Operations Other Than War*. 16 June 1995.

JP 3-07.1. *Joint Tactics, Techniques, and Procedures for Foreign Internal Defense (FID)*. 26 June 1996.

JP 3-07.2. *Joint Tactics, Techniques, and Procedures for Antiterrorism*. 17 March 1998.

JP 3-07.3. *Joint Tactics, Techniques, and Procedures for Peace Operations*. 12 February 1999.

JP 3-07.4. *Joint Counterdrug Operations*. 17 February 1998.

JP 3-07.5. *Joint Tactics, Techniques, and Procedures for Noncombatant Evacuation Operations*. 30 September 1997.

- JP 3-07.6. *Joint Tactics, Techniques, and Procedures for Foreign Humanitarian Assistance*. 15 August 2001.
- JP 3-07.7. *Doctrine for Civil Support*. TBP.
- JP 3-08. *Interagency Coordination During Joint Operations*. 2 volumes. 09 October 1996.
- JP 3-10. *Joint Doctrine for Rear Area Operations*. 28 May 1996.
- JP 3-10.1. *Joint Tactics, Techniques, and Procedures for Base Defense*. 23 July 1996.
- JP 3-16. *Joint Doctrine for Multinational Operations*. 05 April 2000.
- JP 3-35. *Joint Deployment and Redeployment Operations*. 07 September 1999.
- JP 3-53. *Doctrine for Joint Psychological Operations*. 10 July 1996.
- JP 3-57. *Joint Doctrine for Civil-Military Operations*. 08 February 2001.
- JTF Commander's Handbook for Peace Operations*. 16 June 1997. Available [Online] at <http://carlisle-www.army.mil/usacsl/divisions/pki/Military/Doctrine&Concepts/k516.pdf>

ARMY PUBLICATIONS

Most Army doctrinal publications are [online] available at <http://155.217.58.58/atdls.htm>

- AR 190-14. *Carrying of Firearms and Use of Force for Law Enforcement and Security Duties*. 12 March 1993.
- AR 381-10. *US Army Intelligence Activities*. 01 July 1984.
- AR 500-51. *Support to Civilian Law Enforcement*. 01 July 1983.
- AR 500-60. *Disaster Relief*. 01 August 1981.
- AR 700-137. *Logistics Civil Augmentation Program (LOGCAP)*. 16 December 1985.
- FM 1 (100-1). *The Army*. 14 June 2001.
- FM 1-04 (27-100). *Legal Support to Operations*. 01 March 2000.
- FM 2-01.3 (34-130). *Intelligence Preparation of the Battlefield*. 08 July 1994.
- FM 2-91.1 (34-7). *Intelligence and Electronic Warfare Support to Low-Intensity Conflict Operations*. 18 May 1993. When revised, FM 2-91.1 will be retitled *Intelligence and Electronic Warfare for Stability Operations and Support Operations*.
- FM 3-0 (100-5). *Operations*. 14 June 2001.
- FM 3-05 (100-25). *Doctrine for Army Special Operations Forces*. 01 August 1999. When revised, FM 3-05 will be retitled *Army Special Operations Forces Doctrine*.
- FM 3-05.30 (33-1). *Psychological Operations*. 19 June 2000.

- FM 3-06 (90-10). *Military Operations on Urbanized Terrain (MOUT) (How to Fight)*. 15 August 1979. When revised, FM 3-06 will be retitled *Urban Operations*.
- FM 3-07.2. *Force Protection*. TBP.
- FM 3-13 (100-6). *Information Operations*. 27 August 1996.
- FM 3-16 (100-8). *The Army in Multinational Operations*. 24 November 1997.
- FM 3-19.15 (19-15). *Civil Disturbances*. 25 November 1985.
- FM 3-19.40 (19-40). *Military Police Internment/Resettlement Operations*. 01 August 2001.
- FM 3-34.112 (5-103). *Survivability*. 10 June 1985.
- FM 3-35 (100-17). *Mobilization, Deployment, Redeployment, Demobilization*. 28 October 1992.
- FM 3-55. *Reconnaissance Operations*. TBP.
- FM 3-57 (41-10). *Civil Affairs Operations*. 14 February 2000.
- FM 3-61 (46-1). *Public Affairs Operations*. 30 May 1997.
- FM 3-90. *Tactics*. 04 July 2001.
- FM 3-93 (100-7). *Decisive Force: The Army in Theater Operations*. 31 May 1995.
- FM 3-100.21 (100-21). *Contractors on the Battlefield*. 26 March 2000.
- FM 3-100.81. *Multinational Operations Handbook*. TBP.
- FM 4-0 (100-10). *Combat Service Support*. 03 October 1995.
- FM 4-02.42 (8-42). *Combat Health Support in Stability Operations and Support Operations*. 27 October 1997.
- FM 5-0 (101-5). *Staff Organization and Operations*. 31 May 1997. When revised, FM 5-0 will be retitled *Army Planning and Orders Production*.
- FM 5-19 (100-14). *Risk Management*. 23 April 1998.
- FM 6-0. *Command and Control*. TBP.
- FM 7-0 (25-100). *Training the Force*. 15 November 1988.
- FM 7-1 (25-101). *Battle Focused Training*. 30 September 1990.
- FM 7-15. *Army Universal Task List*. TBP.

DEPARTMENT OF DEFENSE PUBLICATIONS

DOD Directives available [online] at <http://www.dtic.mil/whs/directives/>

- DOD 5105.38-M. *Security Assistance Management Manual (SAMM)*. 05 February 2002.
- DOD 5240.1-R. *Procedures Governing the Activities of DOD Intelligence Components That Affect United States Persons*. December 1982.

DOD Civil Disturbance Plan, Annex C (Concept of Operations), Appendix 8 (Special Instructions), 15 February 1991; modified by Director of Military Support message 161639Z July 96, Subject: Changes to DOD Civil Disturbance Plan—"Garden Plot," available [online] at <https://freddie.forscom.army.mil/maca/Word/GardenPlot.doc>

DODD 2000.13. *Civil Affairs*. 27 June 1994.

DODD 3025.1. *Military Support to Civil Authorities (MSCA)*. 15 January 1993.

DODD 3025.12. *Military Assistance for Civil Disturbances (MACDIS)*. 04 February 1994.

DODD 3025.14. *Protection and Evacuation of U.S. Citizens and Designated Aliens in Danger Areas Abroad (Short Title: Noncombatant Evacuation Operations)*. 05 November 1990.

DODD 3025.15. *Military Assistance to Civil Authorities*. 18 February 1997.

DODD 5100.1. *Functions of the Department of Defense and Its Major Components*. 01 August 2002.

DODD 5100.46. *Foreign Disaster Relief*. 04 December 1975.

DODD 5100.77. *DoD Law of War Program*. 09 December 1998.

DODD 5105.65. *Defense Security Cooperation Agency (DSCA)*. 31 October 2000.

DODD 5132.3. *DoD Policy and Responsibilities Relating to Security Assistance*. 10 March 1981.

DODD 5160.64. *Federal Legal Information Through Electronics (FLITE) and the Defense Emergency Authorities Retrieval and Analysis System (DEARAS)*. 09 July 1991.

DODD 5240.1. *DoD Intelligence Activities*. 25 April 1988.

DODD 5525.5. *DoD Cooperation with Civilian Law Enforcement Officials*. 15 January 1986.

DODD 5530.3. *International Agreements*. 11 June 1987.

DOD Instruction 2310.3. *Personnel Recovery Response Cell (PRRC) Procedures*. 06 June 1997.

National Military Strategy of the United States of America, 1997. Available [Online] at <http://www.dtic.mil/jcs/nms>

PUBLIC LAWS AND OTHER PUBLICATIONS

The United States Code (USC) is available [online] at <http://uscode.house.gov/usc.htm>

Arms Export Control Act (Public Law 90-629, October 22, 1968, [82 Stat. 1320]; see Title 22 USC, section 2751, Short Title note).

Case Act (see Title 1, USC, section 112b).

Charter of the United Nations. Available [Online] at <http://www.un.org/aboutun/charter/index.html>

- Controlled Substances Act* (see Title 21 USC).
- Convention on the Rights of the Child*. 20 November 1989. Available [Online] at <http://www.unhchr.ch/html/menu3/b/k2crc.htm>
- Convention Relating to the Status of Refugees*. 28 July 1951. Available [Online] at http://www.unhchr.ch/html/menu3/b/o_c_ref.htm
- Economy Act* (Public Law 97-258, September 13, 1982, [96 Stat. 1535]; see Title 31 USC, section 1535).
- Executive Order 10206. *Providing for Support of United Nations' Activities Directed to the Peaceful Settlement of Disputes*. 19 January 1951.
- Executive Order 11850. *Renunciation of Certain Uses in War of Chemical Herbicides and Riot Control Agents*. 08 April 1975.
- Executive Order 12333. *United States Intelligence Activities*. 04 December 1981.
- Federal Response Plan*. Available [Online] at <http://www.fema.gov/r-n-r/frp>
- Foreign Assistance Act of 1961* (Public Law 87-195, September 4, 1961, [75 Stat. 424]; see Title 22 USC, section 2151, Short Title note).
- Foreign Assistance Act of 1961* “The Kennedy Amendment” (Title 22 USC, section 2304[a][2]).
- Foreign Assistance Act of 1961* “The Mansfield Amendment” (Title 22 USC, section 2291[c][1]).
- Immigration and Nationality Act of 1952* (Title 8).
- International and Operational Law Division. *Operational Law Handbook*. Charlottesville, Virginia: The Judge Advocate General School, 1994. Available [Online] at <http://www.jagcnet.army.mil/CLAMO>
- International Narcotics Control Act* (Public Law 102-583, November 2, 1992, [106 Stat. 4914]).
- Judiciary Act of 1789* (see *Posse Comitatus Act*).
- National Defense Authorization Act FY 1989* (Title 42 USC, section 210[a]).
- National Defense Authorization Act FY 1990-91* (Title 10 USC, section 2504).
- National Security Decision Directive 221. *Narcotics and National Security (U)*. 08 April 1986. Available [Online] at <http://www.fas.org/irp/offdocs/nsdd/nsdd-221.htm>
- Posse Comitatus Act* (Title 18 USC, section 1385).
- Presidential Decision Directive 2. *Organization of the National Security Council*. 20 January 1993. Available [Online] at <http://www.fas.org/irp/offdocs/pdd/>
- Presidential Decision Directive 25. *U.S. Policy on Reforming Multilateral Peace Operations*. 22 February 1996. Available [Online] at <http://www.fas.org/irp/offdocs/pdd/>
- Presidential Decision Directive 39. *U.S. Policy on Counterterrorism (U)*. 21 June 1995. Available [Online] at <http://www.fas.org/irp/offdocs/pdd/>

- Presidential Decision Directive 56. *Managing Complex Contingency Operations*. May 1997. Available [Online] at <http://www.fas.org/irp/offdocs/pdd/>
- Presidential Decision Directive 62. *Protection Against Unconventional Threats to the Homeland and Americans Overseas (S)*. 22 May 1998. Fact sheet available [online] at <http://www.fas.org/irp/offdocs/pdd/>
- Robert T. Stafford Disaster Relief and Emergency Assistance Act* (Title 42 USC, sections 5142–5203).
- Rules of Engagement (ROE) Handbook for Judge Advocates*. 01 May 2000. Available [Online] at <http://www.jagcnet.army.mil/CLAMO>
- Sales Program* (Public Law 480). January 1998.
- The CIA World Factbook*. Available [Online] at www.odci.gov/cia/publications/pubs.html
- Title 8 USC. *Aliens and Nationality*.
- Title 10 USC. *Armed Forces*.
- Title 22 USC. *Foreign Relations and Intercourse*.
- Title 32 USC. *National Guard*.
- Title 42 USC. *The Public Health and Welfare*.
- US Department of Defense. *Handbook of DOD Assets and Capabilities for Response to a Nuclear, Biological, or Chemical Incident*. Washington, DC: Operations Directorate, Joint Staff, 1996.
- United Nations Participation Act* (Public Law 79-264; see Title 22 USC, section 287). 20 December 1945.
- Universal Declaration of Human Rights*. 10 December 1948. Available [Online] at <http://www.un.org/Overview/rights.html>
- War Powers Act* (Public Law 93-148). 07 November 1973.

Index

Entries are by paragraph number unless figure (fig.) or page (pg.) is specified.

A-B

accountability, 4-16, 4-65
adaptability, 1-96, 4-78
administration officer, A-40
advanced military training, 6-79
adversary, 1-57
 capabilities, 2-78
 countering, 2-65
 HUMINT, 2-11
 support operations, pg. 6-1
agencies, CD operations, 5-24
 SA, 5-14–5-17
agility, 1-94–1-96
agreements, 4-118
 community, 6-121
air and missile defense, 2-31–
 2-32
air defense, 2-29–2-32, 2-64
air surveillance, 2-100
ambassador, A-35–A-36
antiterrorism. *See* AT
appropriation acts, B-20
AR 381-10, B-23
area of interest, IPB, D-11
area of separation, 4-15
armed conflict, results of, 4-34
Armed forces, civil law, B-10
arms control, 5-68–5-72
 definition, 5-68
 diplomatic mission, 5-69
 DOS, 5-70
 participants, 5-71
Arms Export Control Act, 3-29
Army, assistance from, 6-78
 commitment of, 2-57
 LEA, 6-78

 responsibilities, 4-117
Army assets, 2-83
Army forces, assistance from,
 4-108, 4-112, 6-48, 6-71, 6-87,
 6-99, 6-121
 capabilities, 2-82, 6-76
 civilian law enforcement, 6-59
 communications, 6-66
 CT operations, 6-76
 FID, pg. 3-0
 impacts of, 6-124
 insurgents and, 5-21
 NGOs, A-54
 participation, 6-124
 PO, 4-115
 relief operations, 6-36
 support from, 4-106, 5-28,
 5-31, 6-34, 6-45
 support functions, 6-65
 tasks, 4-109
Army National Guard. *See* ARNG
Army special operations forces,
 insurgency, 5-20
ARNG, 6-14, B-19
 assistance from, 6-74
 coordination, 6-84
 training from, 6-80
artillery, 2-22–2-23
assessment, 5-45
 PO, 4-89
assistance, vs. combat mission,
 6-40
 funding for, 6-42
 HN, 3-21
 PK forces, 4-8
 response to, A-6
 restrictions, 6-42

assistance missions, PO, 4-8
AT, 2-66, 5-52–5-57
 definition, 2-66, pg. 5-12
 measures, 5-52
 program, 5-53
attorney general, 6-101
 responsibilities, 6-102
augmentation, 2-96–2-98
authority, for support, 6-8
 levels of, 4-73
 logistics, 4-118
authorization acts, B-20
balance, 1-76
balance of power, 1-28
battlefield organization, 1-46
belligerents, 2-30, 4-20, 4-47, F-4
 aircraft, 2-32, 2-64
 arms control of, 5-73
 chemicals, 2-39
 defense, 2-65, 2-81
 disarming, 1-47, 4-16–4-17
 EW, 4-95
 IO, 4-105
 PE, 4-23, 4-24
 PO, 4-48
 requirements, 4-7
 separating, 4-11, 4-14–4-18
bodies of law, B-4–B-8
broadcast dissemination, 4-81

C

C2, 2-49–2-56, 4-71–4-79
 PO, 4-71
 relationships, 5-44
C2 process, DSO, 6-53–6-58
C4 support, 5-34

- CA, CD operations, 5-33
 CMO, 2-61, 3-4
 DSO, 6-17
 insurgency, D-10
 liaison, A-88
- CA assistance, PO force, 4-61
- campaign plan, joint, A-21
- capabilities, Army, 1-45
 balance, 2-39
 militia forces, 3-16
- CBRNE, attack, 6-51
 determination, 6-54
 prevention of, 6-47
 threat, 6-50
 US Army Reserve, 6-16
- CBRNE consequence management, fig. 6-4
 support to, 6-45–6-71
- CBRNE incidents, definition, pg. 6-12
 deployment, 6-48
 resources needed, 6-46
 response to, 6-45, 6-61
- CBT, 5-49–5-57
 DSO, 6-10
- CD, 5-23
 training, 6-80
- CD efforts, funding, B-20
- CD mission, 6-77
- CD operations, agencies, 5-24
 CMO, 5-33
 coordination, A-16
 vs. DSO, 6-32
 FID, 5-31
 principles, 5-25
 SA, 5-32
 support provisions, 6-83–6-84
 support request, 6-82
 support to, 5-23–5-48, 6-77–6-84
 types of support, 5-30–5-40
- CD organizations, 5-27, fig. 5-1
- CD programs, B-17
- cease-fire, 4-8
- center of gravity, 2-7
- Central Intelligence Agency, A-48
- chain of command, 2-44
- chemical herbicides, B-35
- chemical units, 2-39
- chemical, biological, radiological, nuclear, and high explosive.
 See CBRNE
- chief of mission. See COM
- chief of station, A-39
- citizens, evacuation of, 5-58
 protect, 6-87
 rights, 6-86
- civil affairs. See CA
- civil authorities, 6-86
 assistance from, 6-54
 assistance to, 6-48, 6-74, 6-85, 6-87, 6-99, 6-102
 coordination, 6-89
 military forces, 6-88
 PK forces and, 4-8
 support to, 6-83
- civil considerations, 2-7, 2-57
- civil defense emergency, definition, 6-4
- civil disturbance, commander, 6-96
 definition, pg. 6-21, 6-5
 Insurrection Act, 6-31
 military force, 6-89
 transition, 6-97
 types, 6-86
- civil disturbance mission, 6-104
- civil disturbance operations, 6-85–6-104
 conducting, 6-87–6-98
 general support, 6-105
 military assistance for, 6-101
 military forces, 6-95
 roles, 6-98–6-100
 training, 6-98
- civil law and order, 4-106–4-112
- civil law enforcement, 6-72–6-74
- civilian, assistance, 4-8, 4-20, 4-25, 4-33
- benefits to, 6-117
- capabilities, 4-61
- effects of, 2-58
- law, B-12
- medical care, 2-47
- organizations, 3-20
- prisoners, 4-109
- support by, 2-93
- tasks, 4-61
- threats to, 6-59
- civilian agency, 1-21, 1-51, 1-60, 1-74, 1-86–1-87, 2-55
 activities, 4-65
 CMO, 4-62
 engineer, 2-37
 responsibilities, 4-29, 4-62, 4-67, 4-106
 RTF, 6-58
 support to, 5-31, 6-1
- civilian assets, 4-64
- civilian forces, to military forces, pg. 4-2
- civilian government, 6-23
- civilian law enforcement, 6-24
 Army forces, 6-59
- civilian officials, civil disturbance operations, 6-102
 command, 6-92
- civilian police, 4-8, 4-43
 authority, 4-107
 responsibilities, 4-110
 tasks, 6-95
 training, 4-25
- civilians, 4-57
 assistance to, 6-65
 military support of, B-14
 responsibilities, 6-60
 support to, 6-117
- civil-military operations. See CMO
- civil-military operations center.
 See CMOC
- claims administration, B-34
- CMO, 1-21–1-23, 1-51, 2-58–2-61, 3-3, 3-4, 4-59–4-67
 activities, 4-33

- CMO (*continued*)
- CA, 2-61
 - CD operations, 5-33
 - commander, 3-4
 - credibility, 4-59
 - definition, 2-59
 - FID, 3-4
 - fratricide avoidance, 2-71
 - IO, 2-74
 - objectives, 2-60
 - PO, 4-59, 4-62
- CMOC, A-77–A-84
- establishment of, A-82
 - sample organization, fig. A-3
 - force protection, A-80
 - HN, A-78
 - logistics, 4-115
 - members of, A-81
 - NGOs, A-51
 - organization, fig. A-4
 - PAO, A-84
 - tasks, A-77, A-83
 - variations, A-79
- coalition, training, 2-51
- coherence, 4-65
- COM, A-35–A-36
- assistance to, 5-64
 - responsibilities, 5-59, 5-62, A-35
- combat, PIR, 2-14
- stability operations and support operations, 2-1
 - training, 2-80
 - US forces, 3-23
- combat engineer support, 2-36
- combat forces, 3-25
- neutralization, 3-11
 - PE, 4-13
- combat health service support, 2-47
- combat operations, 3-7, 3-30, 4-25
- counterinsurgency, 3-23
- combat power, 1-11, 1-78–1-80, 1-98, 2-21
- combat service support. *See* CSS
- combat support. *See* CS
- combat training, 2-81
- combatant command, 2-45, 6-107, A-7, A-36
- application to, C-8
 - civil disturbance operations, 6-103
 - domestic emergencies, 6-21–6-22
 - levels of, 1-87
 - provides, 3-21
 - responsibilities, 6-104
- combatant commander, 2-85, pg. 3-0, 3-21, 6-9, 6-64, A-10, A-35, C-9
- chain of command, A-76
 - considerations, 5-3
 - control, C-10
 - decisions, 5-18
 - designation of, A-9
 - FHA, 6-34
 - interagency organization, 5-71
 - POLAD, A-22
 - responsibilities, 5-16, 5-19, 5-31, 5-62, 6-56, 6-61, 6-63, A-20, A-21, A-29
 - SA, 5-15
 - support of, 5-28
 - theater strategy, 1-40
 - USDR, A-38
 - use of assigned forces, 6-8
- combatting terrorism. *See* CBT
- command, relationships, 2-53–2-54
- command and control. *See* C2
- command emphasis, 6-108
- command relationships, 4-72–4-77
- command, control, communications, and computer. *See* C4
- commanders, action, 5-51
- adaptability, 1-96, 2-8, 2-62, 2-84, 2-99, 4-78, 4-81, 6-123, A-21, A-69
- assistance to, 6-89
 - authority, 6-41, A-17
 - balance, 2-63
 - civil disturbance, 6-96
 - concern, 4-45
 - considerations, 2-30, 2-58, 2-64, 2-68, 2-86, 2-91, 2-94, 2-97–2-98, 3-4, 3-29, 4-21, 4-40, 4-44, 4-66, 4-69, 4-71, 4-82, 4-95, 4-105, 4-107, 4-120, 5-76, 6-40, 6-41, 6-66, 6-90, 6-97, 6-106, 6-119, 6-122, 6-128, A-80, B-32
 - consistency, 6-112
 - expectations, 2-51, 2-57, 4-19
 - flexibility, 1-73, 1-95–1-96, 2-44, 2-50, 2-57, 4-58, 6-96, A-17, B-8
 - goals, 6-118
 - initiative, 4-58
 - law, B-1
 - limitations, 4-92
 - media, 4-97
 - negotiator, 4-15, 4-97
 - NGOs, 1-65
 - PO, 4-77
 - relationships, 6-108, 6-118
 - requirements, 4-116
 - responsibilities, 1-37, 1-52, 1-57, 1-63, 1-82, 1-88, 2-1, 2-5, 2-7, 2-11, 2-13, 2-22, 2-39, 2-45, 2-52, 2-57, 2-66, 2-69, 2-96, 4-7, 4-43, 4-53, 4-58, 4-68, 4-97–4-98, 4-108, 5-37, 5-46, 5-50, 5-59, 5-63, 6-23, 6-96, 6-107, A-10, pg. C-1
 - ROE, pg. C-1
 - role, 4-77
 - stability operations and support operations, 5-16
 - tasks, 3-21
 - UN, A-76
- commander's concept, A-21
- commercial and/or economic officer, A-42

- communications, CBRNE incident, 6-54
- community assistance, 6-123
 - crisis management, 6-66
 - developing, 5-10
 - interoperability, 5-47
 - liaison, A-85
 - negotiations, E-9
 - SAO, A-33
 - sharing, 3-5
 - transparency, 4-50
- community, benefits, 6-111, 6-128
- training for, 6-122
- community assistance, 6-106–6-129
- common interest, 6-112
 - competition, 6-113
 - cooperation, 6-120–6-129
 - critical services, 6-121
 - fundamentals of, 6-107
 - goals, 6-110
 - impact of, 6-106, 6-107, 6-109, 6-111
 - local efforts, 6-117–6-119
 - profit, 6-114
 - requests, 6-119
 - state efforts, 6-117–6-119
 - types, 6-115–6-129
- community cooperation, 6-120–6-129
- community council, 6-123
- community service, 6-126–6-127
- complex contingency operations, definition, 4-34
- complex situations, causes, 1-35–1-37
- concentration, pg. 3-5
- concept of employment, 4-34–4-39
- concept of operations, 1-46
- concept of the enemy, 1-57–1-58
- conflict resolution, E-12
- conflicts, coordination, 1-85
- effects of, F-4
 - frequency, fig. 1-4
- historical, 1-22–1-23
- issues, E-2
- modern, 1-24–1-27
- consent, 4-41–4-46, 4-59
- commitment to, 4-46
 - difficulties, 4-43
 - force capability, fig. 4-1
 - IO, 4-91
 - levels, 4-41
 - loss of, 4-45
 - players, 4-44
 - promotion of, 4-42, 4-44
- consequence management, 6-51
- assistance to, 6-52, 6-54
 - CBRNE incident, 6-56
 - definition, pg. 6-14
 - foreign, 6-61–6-64
 - terrorism, 6-76
- consequence management response, 6-10
- consequence management support functions, 6-65–6-71
- consequences, to stability operations, 1-8
- considerations, employment, 1-41
- negotiations, E-1–E-7
 - ROE, C-1–C-4
 - types, E-2–E-7
- constraints, 1-68
- consular officer, A-43
- contingency plan, 2-68
- contingency planning, A-12
- contraband, 4-21, 4-26
- contractors, 2-44
- conventional warfare, D-19
- cooperation, community assistance, 6-117
- negotiation, E-3
 - requirements, 6-72
- coordination, 1-81–1-87, 4-65, 4-78–4-79
- augmentation, 2-96
 - civil authorities, 6-89
 - CMOC, 4-79
 - conflicts, 1-85
- DSO, A-15
- evacuation, 5-66
- FHA, 6-34
- FRP, A-9
- HCA, 5-18
- intelligence, 4-90, 5-42
- interagency, 1-59
- IO, 1-66
- joint, 1-59
- LEA, 6-94
- military assistance, 6-101
- multinational, 1-59
- NGOs, A-57
- of support, 6-84
 - RTF, 6-58
 - security, 2-68, 2-70
 - theater orientation, A-20
- counterdrug. *See* CD
- counterinsurgency, 3-8–3-25, 3-21
- challenges, 3-18
 - combat operations, 3-23
 - defense of, 3-17
 - definition, 3-8
 - military operations, 3-12
 - neutralization, 3-11
 - role of the Army, 3-21–3-25
 - security forces, 3-14
- counterintelligence, 2-11
- counterterrorism. *See* CT
- country team, A-25–A-26
- definition, A-25
 - members, fig. A-1
- credibility, 4-55–4-56, 4-120
- crime, 3-18, 4-22, 6-85
- criminal investigation command, 5-27
- crisis, response to, 1-39
- crisis management, 6-50
- communications, 6-66
 - country team, A-26
 - definition, pg. 6-14
 - response, 6-10, 6-58
 - support to, 6-52
 - terrorism, 6-76

- critical assets, protection of, 6-59–6-60
- CS, 2-2, 2-93, 6-89
- CSS, 2-2, 2-40–2-48, 2-93
- assets, 2-41
 - capabilities, 2-46
 - CD operations, 5-37
 - civil disturbance, 6-89
 - replacement, 2-42
 - roles, 2-40
 - support, 2-46
- CT, 5-51
- Army forces, 6-76
 - definition, pg. 5-12
 - support to, 6-75–6-76
- cultural awareness, insurgency, D-10
- training, 3-2
- cultures, clash of, 1-30
- effects of, 2-7, E-11
 - interacting, 1-69–1-70
 - negotiations, E-5
- D**
- DCO, 6-13
- responsibilities, A-10
 - STARC, 6-15
- decision cycle, IO, 4-97
- decisive operations, 1-47–1-49
- definition, 1-47
 - in support operations, 1-48
- defense, pg. 3-5
- government, 3-15
 - insurgency, 3-12
- Defense Attaché Office, A-27
- defense coordinating officer. *See* DCO
- Defense Security Cooperation Agency, 5-15
- defensive action, 5-49
- defensive IO, 2-76–2-78
- definition, 2-76
- defensive operations, 3-7
- combat forces, 3-25
 - FID, 3-31
- vs. PO, 4-47
 - vs. stability operations and support operations, 2-2, 2-7, 2-14–2-15, 2-52, 2-57
 - transition, 2-88
- demining operations, 4-17
- demobilization, 4-18
- demographics, 1-31
- Department of Defense. *See* DOD
- Department of State. *See* DOS
- deployment, 2-79–2-102, 4-30, 4-62
- HCA, 5-18
 - IO, 4-105
 - PK force, 4-8, 4-38
- depth, 1-97
- deputy chief of mission, A-37
- detection and monitoring, CD operations, 5-30
- diplomacy, PK forces, 4-8
- diplomatic actions, 4-30, 4-36
- diplomatic efforts, 4-31
- military support of, 4-29–4-33
- diplomatic mission, arms control, 5-69
- direct support, 3-3–3-6
- Director of Military Support. *See* DOMS
- disarming, 4-17
- disaster assistance, A-3
- disaster assistance operations, 6-24
- disaster assistance response team, A-50
- disaster preparedness, B-28
- disaster relief operations, execution of, A-10
- stages, 6-43
- displaced persons, F-18–F-20
- doctrine, foundations of, 1-71–1-90
- DOD, assistance from, 6-1, 6-65, A-11
- cooperation, 6-72
 - coordination with, A-23
 - interaction, A-12
- NGOs, A-53
- state support, A-13
- DOD policy, law of war, B-26
- DOD response, foreign consequence management operations, 6-64
- domestic emergencies, 6-3–6-7
- definition, 6-3
- domestic preparedness, 6-47
- domestic relief operations, fig. 6-3, A-3–A-18
- domestic support, 6-2
- domestic support operations. *See* DSO
- DOMS, authorization, 6-40
- considerations, 6-22
 - coordination, 6-103, A-11
 - tasks, 6-10
- DOS, arms control, 5-70
- responsibilities, A-24–A-47
- drawdown authority, 5-13
- DSO, 1-15, 3-3, 6-1–6-32
- assistance from, 6-1, 6-16
 - CA, 6-17
 - CBT, 6-10
 - contingency planning, A-12
 - coordination, 6-1, 6-26, A-15
 - vs. FHA, 6-37
 - intelligence, 6-24
 - liaison, 6-1
 - reconnaissance, 2-12
 - roles and responsibilities, 6-8–6-17
 - SROE, C-10
 - support to, 6-26
 - warfighting skills and, 2-82
- E**
- Economy Act, B-18
- economy of force, 1-79
- elections, 4-8
- electronic, translation, 2-102
- electronic warfare. *See* EW
- embassy, coordination, A-27
- organizations, A-25–A-34

embassy (*continued*)
 representatives, A-35–A-47
 Emergency Action Plan, 5-62
 emergency powers, 3-15
 emergency support functions,
 6-19, fig. 6-2
 emergency support requests, 6-22
 employment, reasons, 1-42–1-45
 end state, 4-2, 4-8, 4-70, 4-78,
 6-106, A-21, D-7, D-8
 achieving, 4-42
 mission analysis, 1-63
 mission creep, 1-62
 objectives for, 1-73
 PO, 4-1
 enemy, pg. 6-1
 attack, 6-3, 6-4
 combat power, 1-78, 1-80
 concept of, 2-57
 firepower, 2-63
 modified concept of, 1-57
 PE, 4-9
 PIR, 2-14
 PO, 4-3
 prisoners, F-4
 security against, 1-88
 surprise of, 1-89
 targets, pg. C-1
 engineer operations, 2-33–2-39
 engineer support, 2-35, 6-68
 general, 2-37–2-38
 enhancement, community
 assistance, 6-109
 environment, 1-97
 assistance to, 6-111
 characteristics, D-11
 disaster to, A-11
 effects of, 2-58, D-9
 FID, 3-27
 insurgency, D-9–D-11
 PO, 4-78
 security, pg. 4-1, 4-106
 training, 6-110
 environmental risks, 1-33

equipment, excess, 5-12
 SA, 5-3
 essential elements of friendly
 information, 2-11, 2-77
 essential support, 1-18
 evacuation, 2-68
 coordination of, 5-66
 emergency, 5-65
 planning, 5-61, 5-63
 repatriation, 5-67
 security, 5-59, 5-66
 evacuation control center, 5-65
 evacuation force, 5-64
 organization, fig. 5-2, 5-63
 evacuation site party, 5-63
 EW, 4-95
 executive orders, B-22–B-23
 exercises, 3-2
 external support, insurgency,
 D-12–D-13
 types, D-12

F

FAA, 3-6, 5-12, 5-29, A-49, B-17
 authority, A-68
 FID, 3-29
 faction, 1-50, 1-85, 1-92, 1-97,
 2-7, 2-57, 4-8, 4-30, 4-31, 4-47,
 4-51, 4-55, 4-93, 5-76
 FCO, 6-12
 disaster, A-8
 FRP, A-10
 responsibilities, A-8
 vs. SCO, A-14
 federal assistance, 6-19
 Federal Bureau of Investigation,
 6-50
 federal coordinating officer. *See*
 FCO
 federal crisis management, 6-49
 Federal Emergency Management
 Agency. *See* FEMA
 Federal Response Plan. *See* FRP
 FEMA, B-28
 C2, 6-18

coordination, 6-18, 6-55, A-8
 DCO, 6-13
 FCO, 6-12
 MSCA, A-7
 responsibilities, 6-18, 6-51
 support to, 6-20
 FHA, 1-16, 6-33–6-34
 CMO, 3-4
 definition, pg. 6-8
 vs. DSO, 6-37
 limitations, 6-33
 PK forces, 4-8
 political objectives, 1-56
 reconnaissance, 2-12
 vs. support operations, 6-35
 warfighting skills and, 2-82
 FID, categories of, 3-1–3-7
 CD operations, 5-31
 CMO, 3-4
 vs. defensive operations,
 3-31
 definition, pg. 3-0
 laws, 3-29
 vs. offensive operations, 3-31
 planning considerations,
 3-26–3-30
 SA, 5-9, 5-11
 strategic effects, 3-26
 field discipline, 2-62, 2-69
 fire support, 2-21–2-28
 coordination, 2-25
 lethal capabilities, 2-21–2-26
 nonlethal capabilities, 2-27–
 2-28
 ROE, 2-26
 first responders, 6-53
 fiscal law, B-21
 flexibility, 1-80, 1-96, 4-58
 force, actions, 4-48
 amount of, 1-75
 application of, 1-10–1-11
 credibility, 4-55
 demonstrate, 1-9
 suitability, 2-92

- force capability, consent, fig. 4-1, 4-41
- force protection, 2-62, 2-63–2-68, 4-118–4-121
- AT, 5-53
 - CBT, 5-50
 - CMOC, A-80
 - information, 2-77
 - level of, 4-119
 - locations, 2-68
 - peace building, 4-118
 - ROE, C-2
 - support for, 4-90
 - training, 2-45
- force tailoring, 2-91–2-95, 2-96
- definition, pg. 2-23
 - flexibility, 4-58
- forces, employment of, 3-31
- IO, 4-49
 - organization, 1-46
- Foreign Assistance Act. *See* FAA
- foreign consequence management, military support to, 6-61–6-64
- foreign consequence management operations, 6-61
- foreign humanitarian assistance. *See* FHA
- foreign internal defense. *See* FID
- foreign military financing program, 5-9
- foreign military sales, 5-8
- foreign operations, A-19–A-76
- authority, A-19
- forward command element, 5-63
- fratricide avoidance, 2-62, 2-71
- freedom of movement, 4-57
- FRP, 6-18–6-32, A-4–A-11
- application of, A-5, A-6
 - authority, A-9
 - coordination, 6-12, 6-18
 - structure, 6-19
 - support of, A-4
- full spectrum operations, pg. 1-1, 1-45, 1-99
- fundamentals, community assistance, 6-107–6-114
- funds, community assistance, 6-114
- SA, B-17
- G-H**
- GARDEN PLOT, 6-99
- application of, 6-100
 - civil disturbances, 6-87
- general services officer, A-40
- general support, civil disturbance operations, 6-105
- Geneva Conventions, B-24
- geography, insurgency, D-9–D-11
- governability, failures, 1-32
- government, defense, 3-15
- legitimacy, 3-15, 3-17
- government forces, actions, 3-18
- graduated response, ROE, C-6
- ground reconnaissance, 4-84
- ground surveillance, 2-100
- guerilla, protection from, 3-17
- tactics, pg. 3-5, 3-13
 - warfare, D-18
- handover, 2-87
- HCA, 5-18–5-19
- assistance, 5-18
 - CMO, 3-4
 - costs, 5-19
- HN, assistance, 2-31, 2-37, 2-47, 3-3, 3-7, 3-21, 3-25, 4-33, 4-107, 5-2, 5-34, 6-33, 6-63, A-28, A-32
- capabilities, 1-7
 - CBRNE incident, 6-62
 - CMOC, A-78
 - FID, 3-27
 - IDAD, 3-28
 - infrastructure, 3-5
 - international agreements, B-27
 - relations, 3-2
 - responsibilities, 3-31, 4-17, 4-110, 5-30, 6-36, 6-62
- security, 3-24
- security force operations, 3-14–3-20
- support from, 2-57
- support to, 4-115, 5-31–5-33, 5-32, 6-78
- war crimes, 4-112
- weakness, 3-5
- HN civil agencies, responsibilities, 6-33
- HN law, B-8
- host nation. *See* HN
- human intelligence. *See* HUMINT
- humanitarian agency, F-10
- humanitarian and civic assistance. *See* HCA
- humanitarian assistance, F-3
- PO, 4-60
 - protection of, 4-28
 - UN, A-69, A-70, A-73
- humanitarian crisis, 4-34
- humanitarian demining operations, 4-17
- HUMINT, 2-9–2-10, 4-81, 4-89
- counterintelligence and, 2-11
 - medical and, 2-9
- I**
- I/R operations, F-4–F-5
- IDAD, 3-15, 3-28
- definition, 3-9
- ideology, insurgency, D-5–D-6
- IDP, F-10–F-12
- definition, F-10
- IEW, 4-81
- immediate response, 6-40, 6-41
- definition, pg. 6-11
 - DSO, A-17
 - duration, 6-42
- impartiality, 4-47–4-49
- compromised, 4-48
 - intelligence support, 4-90
 - transparency, 4-50
 - war, 4-47
- indirect support, 3-2

- individual exchange program, 3-2
- information, 1-66–1-67, 4-93
- collection of, B-22
 - dissemination, 4-44, 6-25, 6-70
 - PO, 4-7
 - SAO, A-33
- information environment, 4-96, 4-104
- information gathering, 4-84
- information management, 2-55–2-56
- definition, pg. 2-13
- information management officer, A-40
- information operations. *See* IO
- information sharing, 2-56, 4-81, 5-48
- civil disturbance operations, 6-105
 - community and, 6-125
 - DSO, 6-24
- information strategy, 4-70
- infrastructure, assistance to, 1-49, 5-10, 6-126
- elements of, fig. 1-6
 - HN, 3-5
 - insurgent, 3-11
 - rebuilding, 4-32, 4-39
 - relief operations, 6-37
- initiative, 1-77, 1-92–1-93
- instability, elements of, 1-28–1-10
- insurgency, 3-12, D-1
- defense, 3-12, 3-21
 - definition, 3-8
 - elements, D-2
 - environment, D-9–D-11
 - external support, D-12
 - geography, D-9–D-11
 - ideology, D-5–D-6
 - IPB, D-11
 - leadership, D-3–D-4
 - objectives, D-7–D-8
 - operations, 5-21
 - phases, D-14–D-20
 - prevention of, 3-16
 - recruiting, 3-17
 - requirements, D-3
 - support to, 5-20–5-22
 - timing, D-15
- insurgents, 3-11, 3-16, 3-25
- Insurrection Act, 6-31
- integration, 4-87, 4-98
- intelligence, 2-6, 3-5, 4-80–4-90, 5-41
- arms control, 5-71
 - capabilities, 3-15, 6-24
 - challenges, 2-13, 4-80, 4-99
 - civil disturbance operations, 6-90
 - coordination, 4-90
 - DSO, 6-24, A-41
 - indications, 4-82
 - organization, 4-81
 - PO, 4-80, 4-81
 - population movement, F-16
 - security forces, 3-19
 - sources, 4-80
 - split-based operations, 2-19
 - synchronization, 2-18, 4-81
 - warnings, 4-82
- intelligence and electronic warfare. *See* IEW
- intelligence estimates, 5-42
- intelligence functions, 4-82–4-90
- intelligence gathering, 4-119
- intelligence preparation of the battlefield. *See* IPB
- intelligence support, 4-81, 5-35
- intelligence, surveillance, and reconnaissance, 1-97, 2-6–2-20
- interagency coordination, 2-52, A-18
- link, pg. A-0
 - national level, A-1–A-3
- interagency organizations, 5-71
- interagency process, 4-43
- interdiction, HN, 5-30
- internal defense and development. *See* IDAD
- internally displaced person. *See* IDP
- international agreements, B-27
- international effort, 4-67
- international law, B-5–B-6
- I/R operations, F-5
 - refugee, F-7
- international military education, 5-10
- international organizations, A-61–A-76
- examples, A-61
 - reconnaissance, 2-13
- internment/resettlement. *See* I/R
- interpret, draft, disseminate, train method, C-11–C-12
- interpreter, tasks, 4-26
- IO, 1-66, 1-97, 2-72–2-78, 4-82, 4-91–4-105
- activities, 2-74
 - credibility, 4-56
 - effects of, 4-91, 4-95
 - forces, 4-49
 - fundamentals, 4-97–4-105
 - IPB, 4-85
 - legitimacy, 4-68
 - multinational forces, 4-98
 - nature, 4-92–4-96
 - needs, 4-99
 - nonlethal capabilities, 2-28
 - preparations, 4-105
 - propaganda, 2-75
 - stability operations, 2-72
 - success, 4-97
 - synchronization, 4-100
 - transparency, 4-50
- IO cell, 4-98
- IO plan, 4-102
- IO support, 4-99
- IPB, 2-7, 4-83–4-85
- conducted, 5-41
 - insurgency, D-11, fig. D-1

J-K-L

Joint Staff, 6-10

Joint Strategic Capabilities Plan, 6-21, B-35

Joint Task Force—Civil Support.
See JTF-CS

JTF, level, 1-87

JTF commander, A-10

JTF-CS, assistance from, 6-56
responsibilities, 6-57

judiciary, 4-108

Judiciary Act, 6-28

justice, peace and, 4-43

law, 1-42–1-44, 4-27, B-1, B-7
application of, B-3
CD operations, 5-24, 5-37
effects of, 4-108
exceptions, B-11
federal, 6-50
fiscal, B-21
foreign operations, A-19
HN, B-8
I/R operations, F-5
reserve component, 6-16
restriction of, 6-105
ROE, C-4
SAO, A-28
three bodies of, B-4

law and order, maintenance, 4-25–4-27
restoration, 4-25–4-27, 6-99

law enforcement, 6-92, 6-105

law enforcement activities, 6-71

law enforcement agency. See LEA

law of armed conflict, B-24–B-26

law of conflict, 2-77

law of war, 4-111, B-24
application of, B-25
compliance, B-26

LEA, 5-28, 5-29
assistance for, 5-34
assistance to, 6-85, 6-87, 6-105

capabilities, 6-99

CD, 6-77

cooperation, 6-72

coordination, 6-94, A-16

exceptions, 6-73

intelligence, 5-41

liaison, 6-90, 6-94

military, 6-93, B-20

OES, A-16

planning support, 5-36

support to, 6-72, 6-77, A-16, B-10, B-14

technology, 6-81

training, 6-79

lead agency, CBT, 5-50
responsibilities, 4-65

lead federal agency. See LFA

leaders, 4-88
considerations, E-1
negotiations, pg. E-0
responsibilities, 4-75, 4-76, 5-42
training, E-20–E-21
types, D-4

leadership, insurgency, D-3–D-4

legal, complexities, B-9
considerations, 6-23–6-26, B-9–B-28
constraints, 5-75
issues, 5-46
restrictions, 3-29, 6-91

legitimacy, 1-75, 4-59, 4-68, D-13
government, 3-15, 3-17, D-8
insurgency, D-15
IO, 4-91
multinational force, 4-3
PE, 4-12
transparency, 4-50

LFA, fig. 6-2
attorney general, 6-102
responsibilities, 6-18, 6-34
support to, 6-57
technical operations, 6-52

liaison, A-85–A-89

civil disturbance operations, 6-90

communications, A-85

community, 6-123

intelligence, 6-90

joint task force, 6-88

LEA, 6-90, 6-94

military police, 6-90

PKO, 4-7

PO, 4-81

requirements, 2-96

RTF, 6-58

success, A-87

teams, 2-97, A-86, A-88–A-89

liaison officer, A-86

local authorities, DSO, A-12–A-18

local guard force, A-45

logistics, 2-40–2-48, 4-113–4-117
nonstandard, 2-42–2-45
SA, 5-15
uses, 2-42

logistics civilian augmentation program, 2-43

logistics support, 3-6, 4-8

M

major disaster, definition, 6-6
response, 6-18

maneuver, 1-80, 2-1–2-5

manpower support, 5-39

mapping, 2-20

marine security guard detachment, A-47

mass, 1-78, 1-93

MDMP, 2-57, 4-1, C-12

measures, of effectiveness, 1-20

media, 1-67, 6-70
influence, 4-35, 4-93, 4-96
information dissemination, 4-81
NGOs, A-56
perceptions, 4-101
terrorism, 5-54
transparency, 4-103

mediation, 4-8

- medical capabilities, 6-69
- METT-TC, analysis, 2-57
- augmentation, 2-96
 - considerations, 2-81
 - PE, 4-12
- military, assets, 4-64
- capabilities, 4-29, 4-114
 - civilian, B-14, B-20
 - liaison, 6-93
 - participation, 3-22, 4-61
 - refugee, pg. F-0
 - response, 6-64
 - security, pg. F-0
- military assistance, pg. 3-0, 4-110, 6-2, pg. F-0
- civil disturbance operations, 6-101
 - coordination, 6-15, 6-101
 - NGOs and, A-57
 - requests for, 6-101–6-104
- military, civic actions, 3-4
- military decision making process. *See* MDMP
- military exchange programs, 3-2
- military forces, assistance from, 6-73, 6-83
- authorization, 6-75
 - capabilities, 3-20
 - civil authorities, 6-88
 - civil disturbance, 6-89
 - civil disturbance operations, 6-95
 - civilians, pg. 4-2, B-12
 - command of, 6-72
 - law, B-1
 - law enforcement activities, 6-71
 - liaison, A-85
 - restrictions, 6-91
 - security from, F-12
 - tasks, 6-91
- military mission, execution of, 6-92
- precedence, 6-26
- military objectives, 1-73–1-76, 4-37
- political objectives, 1-73–1-74
- military observer, 4-74
- military operations, civil disturbances, 6-103
- counterinsurgency, 3-12
 - ROE, C-11
 - SROE, C-9
 - vs. support functions, 6-65
- military police. *See* MP
- military support, diplomatic efforts, 4-29–4-33
- disaster relief operations, 6-43
 - elections, 4-8
 - foreign consequence management, 6-61–6-64
 - peace process, 4-29
 - UN, A-68
- military support to civil authorities. *See* MSCA
- militia, 3-16
- missile defense, 2-64
- mission accomplishment, 4-118
- ROE, C-2
- mission analysis, 2-8, 2-41, 2-57
- CD operations, 5-26
 - FRP, 6-22
- mission command, 5-43
- mission creep, 1-60–1-63
- prevention of, 2-57
- mission essential task list, 2-81
- mission handover, 1-20–1-21
- mission success, 2-7
- mobile security officer, A-45
- mobility operations, 2-4
- mobility/countermobility/survivability, 2-33–2-35
- movement, 4-23–4-24
- restriction of, 4-27
- MP, I/R operations, F-5
- liaison, 6-90
 - restraint, 6-95
 - tasks, 2-68, 4-26, 4-109
- transition, 6-95
- MSCA, A-7
- multiagency operations, 4-1
- transition, 2-87
- multinational, commitment, 4-56
- multinational forces, IO, 4-94, 4-98
- legitimacy, 4-3
 - PO, 4-115
 - SROE, C-10
- multinational operations, authority, A-76
- C2, 2-54
 - counterintelligence and, 2-11
 - transition, 2-87
- ## N
- national efforts, 6-116
- National Guard. *See* NG
- national military strategy, 1-38–1-40
- National Security Council. *See* NSC
- national security policy, A-1
- national security strategy, 1-26, 1-38–1-40
- nationalism, 1-29
- NATO, A-62–A-66
- authorization of, A-66
 - changes, A-64
 - members, fig. A-2
 - US efforts, A-63
- natural disaster, definition, 6-7
- NBC, 2-45, 2-65, 6-69
- negotiation team, 2-98, E-11, E-14, E-17
- negotiations, 4-31, 4-97, E-11
- analysis, E-16
 - arms control, 5-71
 - commander, 4-15
 - considerations, E-1–E-7, E-18
 - goals, E-15, E-16
 - guidelines, E-10
 - implementation, E-19

- negotiations (*continued*)
- implications, E-12
 - leader, pg. E-0
 - levels of, E-7
 - observer force, 4-7
 - participants, E-17
 - PKO, 4-4
 - procedures, E-8–E-19
 - reasons for, E-4
 - SA, 5-15
 - steps of, E-8
 - technique, E-14
 - training, E-20–E-22
 - trust, E-13
- NEO, 5-58–5-67
- characteristics, 5-60
 - conducted by, 5-58, 5-62
 - DSO, A-43
 - operational environment, 5-60
 - political objectives, 1-56
- neutrality, force protection, 4-121
- impartiality, 4-49
- neutralization, 3-11
- NG, 6-14, B-19
- CD, 6-84
 - civil disturbance operations, 6-98
 - commander, 6-88
 - STARC, 6-15
 - weapons of mass destruction
 - civil support teams, 6-54
- NGOs, 1-65, A-51–A-60, F-15
- assistance from, A-52, A-55
 - characteristics, A-52
 - coordination, A-57
 - DOD, A-53
 - duration, A-52
 - examples, A-58
 - funding, A-52
 - operation, A-51
 - PA, A-56
 - reconnaissance, 2-13
 - Red Cross, A-59–A-60
 - support to, A-57
 - variations, A-53
- noncombatant evacuation operations. *See* NEO
- noncombatants, 1-64, 5-61
- nongovernmental organizations. *See* NGOs
- nonlethal capabilities, 2-27–2-28
- North Atlantic Treaty Organization. *See* NATO
- NSC, assistance from, A-48
- guidance from, A-19
 - members, A-2
 - responsibilities, A-1
- nuclear, biological, and chemical. *See* NBC
- O**
- objectives, insurgency, D-7–D-8
- observation missions, 4-7
- observation posts, in PO, 4-7
- observations, movements, 4-23
- observer forces, 4-7
- OCHA, A-67
- coordination, A-71
 - responsibilities, A-73, F-3, F-10
- OES, LEA, A-16
- responsibilities, A-14
- offensive action, 5-49
- offensive IO, 2-73–2-76, 4-91
- definition, 2-73
- offensive operations, 1-77, 3-7
- conducting, 3-19
 - FID, 3-31
 - vs. PO, 4-47
 - vs. stability operations and support operations, 2-2, 2-7, 2-14–2-15, 2-52, 2-57
 - transition, 2-88
- office of emergency services. *See* OES
- operational environment, 4-78
- NEO, 5-60
- operational objectives, insurgency, D-8
- operational patterns, insurgency, D-21–D-22
- operational requirements, ROE, C-2
- operations, insurgency, 5-21
- success in, pg. A-0
- operations security, 4-50, 5-48
- organization, D-17
- P–Q**
- PAO, A-46
- CMOC, A-84
- patriotism, 6-124–6-125
- pattern analysis, 4-85
- patterns, insurgency, D-22
- PE, 4-11–4-13
- consent, 4-45
 - definition, 4-9
 - legitimacy, 4-12
 - METT-TC, 4-12
 - operations, 4-11
 - purpose, 4-9
 - restraint, 4-51
 - stabilization, 4-13
 - transitioning, 4-13
- PE forces, 4-12, 4-16, 4-52
- law and order, 4-26
 - movement, 4-23
 - responsibilities, 4-15, 4-16, 4-26, F-5
 - search, 4-27
 - strengths, 4-24
 - supplies, 4-23
 - task, 4-46
 - use of force, 4-14
- PE mission, 4-36
- PE subordinate operations, 4-14–4-28
- peace, duration, 4-48
- military support, 4-29
 - restored, 4-63
- peace agreement, consent, 4-76
- peace building, 4-39
- activities, 4-33, 4-37
 - definition, 4-32

- peace building (*continued*)
 support to, 4-32–4-33
- peace enforcement. *See* PE
- peace enforcement operations.
See PEO
- peace operations. *See* PO
- peace process, 4-44
 threat, 4-110
- peacekeeping. *See* PK
- peacekeeping operations. *See* PKO
- peacemaking, definition, 4-31
- peacetime, danger, 1-88
- peacetime military engagements.
See PME
- penal, 4-109
- PEO, 4-9–4-28, 4-41
 air defense, 2-64
 conducted by, 4-10
 I/R operations, F-4
 phases, 4-13
 transition, 4-38
- perception, 4-45, 4-48
 Army, 6-118
 ideology, D-6
 impartiality, 4-49
 legitimacy, 4-68
 military forces, 6-116
- perseverance, 4-69–4-70
 synchronization, 4-78
- personal awareness, 4-121
- personnel, credibility, 4-55
 vulnerabilities, 2-68
- personnel exchange program, 3-2
- persuasion, leaders, E-4
- phases, insurgency, D-14–D-20
- PIR, 2-14–2-15
- PK, 4-4–4-6
 definition, 4-4
 force, 4-52
 political process, 4-6
 restraint, 4-51
 techniques, 4-46
 UN, A-74
- PK forces, 4-8
 deployment, 4-8, 4-38
 tasks, 4-7, 4-8
 techniques, 4-6
- PKO, 4-4–4-6, 4-36, 5-11
 consent, 4-45
 liaison, 4-7
 negotiation, 4-4
 tasks, 4-8
 transition, 4-38
 UN Charter, 4-5
- planners, 2-77, 3-26, 3-27, 3-28,
 5-41, B-6
- planning, civil disturbance
 operations, 6-98
 claims, B-34
 evacuation, 5-61, 5-63
 redeployment, 2-89
 stability operations and
 support operations, 2-33,
 2-91
- planning considerations, 2-57–
 2-102, 5-41–5-48, E-1
 DSO, 6-21–6-22
 FID, 3-26–3-30
- planning support, 5-36
- PME, activities, 5-1
- PO, pg. 4-2, 4-47, 4-63
 abilities, 4-79
 assessment, 4-89
 authority, 4-73
 C2, 4-71
 challenges, 4-69, 4-86, 4-93
 CMO, 4-62
 commander, 4-77
 conduct, 4-1
 cooperation, 4-3
 credibility, 4-52, 4-55
 definition, pg. 4-2
 disarming, 4-17
 documents, 4-75
 duration, 4-69
 employment of, 4-2
 end state, 4-1
 environment, 4-58
 forces, 4-61
 forms, 4-1–4-8
 framework, fig. 4-1, 4-38
 fundamentals, 4-40–4-70
 information strategy, 4-70
 integration, 4-87
 IO, 4-97–4-105
 law of war, B-25
 liaison, 4-81
 participants, 4-67
 requirements, 4-61, 4-83
 success, 4-3, 4-39
 support to, 4-114
 synchronization, 4-78
 target, 4-89
 UN, A-69, A-70
 use of force, 4-110
 violations, 4-7
- POLAD, A-22
- police, tasks, 3-15
 training, 4-107
- policy, ROE, C-3
- political, influence, 4-38, 5-59
 support, 4-64
- political action, neutralization,
 3-11
- political advisor. *See* POLAD
- political analysis, 4-86
- political authority, 4-73, 4-76
- political constraints, 5-75
- political movement, 5-54
- political objectives, 1-37, 1-56
 military objectives, 1-73–1-74
 stability operations and
 support operations, 1-54–
 1-56
- political officer, A-41
- political process, peacekeeping,
 4-6
- political-military, 4-78
- politics, UN, A-69
- population, displaced, F-6–F-12
- population movement, F-16–F-17
- posse comitatus, definition, 6-28

- Posse Comitatus Act, 5-23, 6-27–6-30, 6-74, B-10–B-15
 application to, 6-30
 exceptions, 6-27, B-11–B-15
 penalties, pg. 6-7
 post security officer, A-45
 postconflict situations, 1-32
 postinsurgency, D-20
 precautions, 2-68
 predeployment, 2-86
 preference, 4-47
 preinsurgency, D-16
 preparation, 1-90
 preventive deployment, definition, 4-30
 preventive diplomacy, definition, 4-30
 principles of war, 1-72–1-90
 priority intelligence requirements. See PIR
 prisoner, exchanges, 4-8
 propaganda, 1-34, 3-11
 adversaries, 2-75
 protected areas, 4-19–4-20
 protection, 2-62, 4-28
 civilians, B-12
 federal property, B-13
 psychological operations. See PSYOP
 PSYOP, CD operations, 5-33
 CMO, 3-4
 targets, 6-25
 public affairs, 6-70
 IO, 2-74–2-75
 NGOs, A-56
 public affairs officer. See PAO
 public order, PK forces, 4-8
 public support, 6-115
 public works support, 6-68
- R**
- readiness enhancement,
 community assistance, 6-110
 reciprocal unit exchange
 programs, 3-2
- reconnaissance, 2-12–2-13, 4-7,
 5-40
 CD operations, 5-30
 evacuation, 5-63
 recovery operations, 6-43
 Red Cross, A-59–A-60
 redeployment, 2-79–2-102
 refugees, F-6–F-9
 assistance to, F-13
 children, F-19
 definition, F-6
 elderly, F-20
 exceptions, F-8
 vs. IDP, F-10
 military, pg. F-0
 rights, F-7, F-9
 special considerations, F-18–
 F-20
 women, F-18
 regional medical officer, A-44
 regional organizations, A-61–A-76
 regional security officer, A-45
 relations, HN, 3-2
 relationships, 4-66, 5-2
 C2, 5-44
 CBRNE consequence
 management, fig 6-4
 CMO, 4-62
 commanders, 6-108, 6-118
 community, 6-117, 6-124,
 6-127
 countries, 5-60
 FRP, A-9
 legitimacy, 4-68
 PO, 4-62
 relevant information, sharing, 2-55
 relief in place, 2-88
 relief operations, 4-8, 6-36–6-71
 domestic, fig. 6-3, A-3–A-18,
 6-37, 6-38
 FHA, 6-37
 foreign, 6-38
 goals, 6-39
 principles, 6-44
 responsibilities, 6-36
- relief supplies, 4-28
 repatriation, evacuation, 5-67
 reserve components, 2-5, 2-93
 CD operations, 5-35
 law, 6-16
 resource management, 2-48
 resources, 1-27, 1-45, 1-74, 1-93,
 1-97
 authority, A-7
 CBRNE incident, 6-56
 CMO, 4-59
 disaster relief, 6-44
 redeployment, 2-89
 response operations, 6-43
 response task force. See RTF
 restoration, 6-43
 consists of, 6-41
 of order, 4-25
 restraint, 1-75, 2-101, 4-51–4-54
 application of, 4-54
 ROE, 4-51
 riot control agents, B-35
 risks, 1-33
 roadblocks, 2-68
 Robert T. Stafford Disaster Relief
 and Emergency Act. See
 Stafford Act
 ROE, 6-32, C-12
 application of, fig. C-2
 characteristics of, C-7
 considerations, C-1–C-4,
 fig. C-1
 definition, pg. C-1
 example, fig. C-3
 fire support, 2-26
 military operations, C-11
 peacetime vs. wartime,
 pg. C-1
 roles, civil disturbance operations,
 6-98–6-100
 RTF, 6-58
 rule of law, 4-43, 4-106
 rules of engagement. See ROE

S

- SA, 5-1–5-17
 definition, 3-2
 vs. direct support, 3-3
 equipment, 5-2–5-6
 execution of, 5-15
 services, 5-2–5-6
 supervision of, 5-14
 training, 3-2, 5-2–5-6
- SA programs, 3-21, 5-2
 types, 5-7–5-13
- safe area. *See* protected areas
- safety, 2-62, 2-70
- SAO, A-28–A-34
 assistance from, 5-17, A-28
 commander, 5-16
 coordination, 5-3
 designation of, A-30–A-31
 documents, A-34
 functions of, A-32
 organization of, A-29
 training, A-28
- stability operations and support operations, fig. 1-1
 capabilities, 1-79
 challenges, 1-69
 characteristics, fig. 1-7, 1-53–1-70, 1-91–1-99
 combat, 2-1
 coordination, 1-59, 2-49
 execution, 2-93
 foundations, pg. 5-1
 funding, 2-48
 history, 1-22–1-23
 law, B-5
 locations, 1-35–1-37
 military objective, 1-74
 vs. offensive and defensive operations, 2-2, 2-7, 2-14–2-15, 2-52, 2-57
 offensive IO, 2-73
 political objectives, 1-54–1-56
 purpose of, pg. 1-2–1-3
 requirements, 1-53, 2-93
- stabilization, 1-49
 training, 2-84
 trends, fig.1-4, 1-45
- SCO, 6-11, A-14
- secretary of defense, 6-8
- secretary of the Army, 6-9
- security, 1-88, 2-68, 4-16, 4-19, 4-25, 4-120
 children, F-19
 elderly, F-20
 environment, pg. 4-1
 evacuation, 5-66
 HN, 3-24
 information, 1-67
 military, pg. F-0
 NGOs, A-54
 USAID, A-49
 women, F-18
- security assistance. *See* SA
- security assistance funds, B-17
- security assistance organization. *See* SAO
- security force operations, HN, 3-14–3-20
- security forces, capabilities, 3-20
 counterinsurgency, 3-14
 intelligence, 3-19
 neutralization, 3-11
 tasks, 3-15
 treatment, 3-18
- security measures, 2-68
- security operations, 3-10
 combat forces, 3-25
 PEO, 4-14
- self defense, ROE, C-5–C-6
- service support, 5-4
- services, SA, 5-4
- shaping operations, 1-50–1-51
 definition, 1-50
- show of force, 1-78, 5-73–5-76
 definition, 5-73
 escalation, 5-74
 stability operations, 5-76
- situational development, 4-86
- SJA, 5-46
- sniper, 2-68
- soldiers, commanded by, 5-44
 effects of, 4-102
 enhancement of, 6-109
 readiness, 6-110
 support to, 6-117
 training, 1-70, 4-121
- space defense, 2-64
- speaker, community assistance, 6-122
- special considerations, displaced persons, F-18–F-20
- special operations forces, 6-79
- split-based operations, 2-19
- SROE, C-8–C-10
- stability, humanitarian assistance, 4-60
 PO, 4-39
 SA, 5-2
 threats to, 5-20
- stability operations, 1-58
 CD, 5-23
 combat training, 2-81
 considerations, 1-5–1-11
 definition, pg. 1-2
 engineer, 2-36
 initiative, 1-92
 IO, 2-72
 purposes, 1-3
 shaping operations, 1-50
 show of force, 5-76
 support operations and, 1-51
 types, 1-4, fig. 1-2
- stabilization, 3-31, 4-16, 4-95
 HN, 3-24
 PE, 4-13
- staff judge advocate. *See* SJA
- Stafford Act, 6-19, B-28
 authority of, A-4
- standing rules of engagement. *See* SROE
- STARC, 6-14
 DCO, 6-15

- state, emergency, A-14
LEA, B-19
- state area command. *See* STARC
- state authorities, DSO, A-12–A-18
- state coordinating officer. *See* SCO
- states, responsibilities, F-13–F-14
- strategic effects, FID, 3-26
- strategic objectives, 1-76
characterizations, D-7
- strike operations, 3-25
- supervision missions, PO, 4-8
- support, CD operations, 6-82
direct, 3-3–3-6
indirect, 3-2
- support functions, 6-65
- support operations, pg. 6-1
CD, 5-23
considerations, 1-17–1-21
coordination, 1-19
decisive, 1-48
definition, pg. 1-2
forms, pg. 6-1, fig. 6-1, 6-35–6-129
initiative, 1-93
priorities, 1-18
purposes, 1-13
requirements, 2-83
ROE, 6-32
TPFDD, 2-85
training, 6-80
transition to, A-10
types, 1-14–1-16, fig. 1-3, pg. 6-1
warfighting skills, 2-82
- support relationships, A-9
- surprise, 1-89
- surveillance, 2-12–2-13, 2-100, 4-7
- survivability, 2-68
- sustaining operations, definition, 1-52
- synchronization, 1-84, 1-98, 4-78, 4-98, 6-57
intelligence, 2-18, 4-81
- IO, 4-100
power, pg. 4-2
- T**
- tactical air, 2-24
- tactical analysis team, CD operations, 5-35
- tactical objectives, insurgency, D-8
- tactical operations, 3-7
- tactical tailoring, 4-81
- tactics, conventional, 3-12
guerilla, 3-13
- target development, 4-87–4-89
- targeting, 4-87–4-89
- targeting process, activities, 4-87
- targets, 4-87
effects, 4-87
identified, 5-42
leaders, 4-88
monitoring, 2-17
PO, 4-89
PSYOP, 6-25
terrorism, 5-54
- team approach, IO, 4-100
- teams, liaison, 2-97
negotiation, 2-98
training, 5-6
- technical equipment, LEA, 6-81
- technical operations, 6-52
definition, pg. 6-15
- technology, CD operations, 6-81
effects of, 2-101
special, 2-99–2-102
suitability, 2-99
- tenets of Army operations, 1-91–1-99
- terrain, 2-57
- terrorism, 2-66, 6-85
definition, 5-49
media, 5-54
NBC, 6-69
response to, 6-47, 6-49
- terrorist groups, 5-57
- terrorist objectives, 5-56
- terrorist tactics, 5-55
- theater orientation, foreign operations, A-20–A-22
- theater strategy, combatant commander, 1-40
- threats, 1-26–1-27, 3-2
air and missile defense, 2-30–2-31
- time, 2-57
- time-phased force and deployment data. *See* TPFDD
- Title 10, 1-43, fig. 1-5, 5-27, 6-77, 6-105, B-3, B-14, B-16
HCA, 5-18
restrictions, 2-47
- Title 32, 1-43, 5-27, B-19
- TPFDD, 2-85
- training, 4-66
air defense, 2-29, 2-64
C2, 2-51
CA forces, 6-17
CD operations, 5-25–5-26, 6-79–6-80
civil disturbance operations, 6-98
civilian police, 4-25, 4-107
country team, A-26
demining, 4-17
enhancement, 6-110
force protection, 2-45
fratricide avoidance, 2-71
vs. insurgents, 3-21
international, 5-10
law enforcement officials, 6-105
leaders, E-20–E-21
methods, 5-6
NBC defense, 2-65
negotiations, E-20–E-22
provides, 5-5
resources, 6-80
restrictions, 6-24
ROE, C-12
SA, 3-2, 5-5–5-6, 5-32

training (*continued*)
 safety, 2-70
 SAO, A-28
 stability operations and support operations, 2-84
 teams, 5-6
 terrorists tactics, 5-55
 troops, 2-80–2-84
 training support, CD operations, 5-38
 funding, 5-38
 LEA, 6-79
 transition, 2-87–2-88, 4-18, 4-37, 4-48, 4-62
 in relief, 6-41
 from LFA, 6-57
 MP, 6-95
 PE, 4-13, F-5
 to peace, 4-58
 planning, 2-87
 transparency, 1-89, 4-50
 force protection, 4-121
 intelligence support, 4-90
 IO, 4-91, 4-103
 transportation, 6-67
 trends, 1-26–1-27, fig. 1-4
 troops, 2-57
 well being, 2-69

U–V

UN, A-67–A-76
 authorization, A-69
 commander, A-76
 coordination, A-67, A-70
 military support to, A-68
 PK, A-74
 US representative, A-67
 UN Charter, 4-10, 4-36, 4-45
 PKO, 4-5
 UN Development Program, A-75
 UN Office for the Coordination of Humanitarian Affairs. *See* OCHA

UN Office of the High Commissioner for Refugees. *See* UNHCR
 UN Participation Act, A-68
 UN Secretary General, A-72
 UNHCR, F-1–F-3
 assistance from, F-10
 children, F-19
 participants, F-2
 responsibilities, F-1
 unit readiness, 6-110
 United Nations. *See* UN
 United States. *See* US
 units, enhancement of, 6-109
 unity of command, 1-81–1-87
 unity of effort, 1-19, 1-59, 1-82, 1-84, 2-49, 2-55
 NGOs, A-52
 requirements, 1-86
 US, assistance from, 5-13
 policy, 1-38–1-41
 refugee definition, F-6
 US Agency for International Development. *See* USAID
 US Army Reserve, 6-16
 US defense representative, 5-16, A-38
 US forces, 4-72
 civil disturbances, 6-31
 combat, 3-23
 HN law, B-8
 mines, 4-17
 support, 4-29
 tasks, 4-18, 4-20
 US law, B-7
 US representative, UN, A-67
 US support, insurgency, 5-21
 USAID, A-49–A-50
 use of force, 4-51–4-54, 6-32
 versatility, 1-99
 violence, 4-30

W–X–Y–Z

war, impartiality, 4-47
 war crimes, 4-110–4-112

War Power Resolution. *See* WPR
 warfighting skills, 2-82
 WPR, B-29–B-33
 assignment, B-30
 commander, B-32
 duration, B-33
 procedures for, B-31
 requirements, B-29
 zone enforcement, 4-21–4-22

FM 3-07 (FM 100-20)
20 FEBRUARY 2003

By order of the Secretary of the Army:

ERIC K. SHINSEKI
General, United States Army
Chief of Staff

Official:

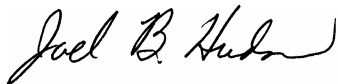

JOEL B. HUDSON
Administrative Assistant to the
Secretary of the Army
0232404

DISTRIBUTION:

Active Army, Army National Guard, and US Army Reserve: To be distributed in accordance with initial distribution number 115882, requirements for FM 3-07.

PIN: 080499-000